

CIRCULATION LARGER THAN ALL OTHER RADIO MAGAZINES COMBINED

RADIO NEWS

REG. U.S. PAT. OFF.

20 Cents
January
1921

Over 100 Illustrations
Edited by H. GERNSBACH

GRANDMA "LISTENS" IN.

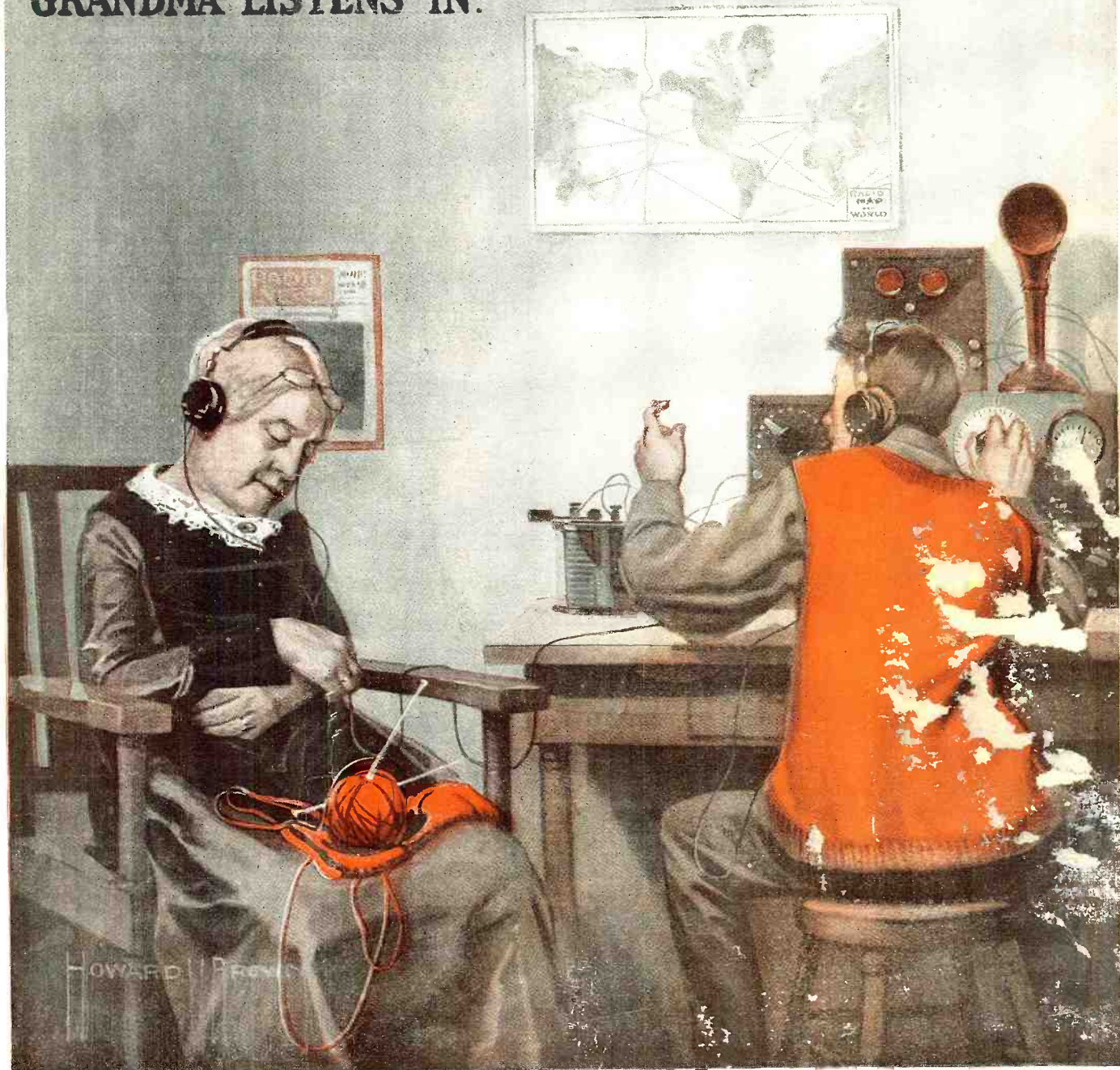

HOWARD PYLE

"THE 100% WIRELESS MAGAZINE"

It Merits Your

Investigation

**Demand
Cunningham
Tubes**

The Name is etched
on the glass



TYPE C-300
**The Ideal
Amateur Tube**
\$5.00

Cunningham Audiotron Tubes **WITH STANDARD FOUR PRONG BASE**

THESE tubes embody all the knowledge and skill of many years research by the leading vacuum tube engineers. The New CUNNINGHAM TUBES are manufactured to rigid specifications in the world's largest vacuum tube factory. Quantity production by machinery makes possible the remarkable price.

Receiving tubes are of two general types. The high vacuum Navy type of rigid operating specifications for radio and tone frequency power amplification. Plate and filament adjustment are not critical. Detector properties are sacrificed to provide maximum amplification in multi-stage and complex circuits without distortion. An amplifying tube is necessarily an oscillator.

The gas content type designed for maximum signal audibility and sensitiveness in detector circuits.

CUNNINGHAM TYPE C-300

is of the latter class and its combination properties exceeded the expectations of its designers. The plate requires only 22½ volts—a single block. Maximum sensitiveness is always between

SEE YOUR DEALER TODAY and get your copy of Bulletin C-300 describing these new tubes. If your dealer cannot supply you send us his name and address and we will mail you a copy without charge.

Cunningham tubes are covered by patents dated 11-7-05, 1-15-07, 2-18-08, and others issued and pending. Licensed only for amateur or experimental uses in radio communication. Any other use will be an infringement.

Service and Quality since 1915

Guaranteed by

TRADING AS

AUDIOTRON MFG. COMPANY

35 MONTGOMERY ST. DEPT. N

SAN FRANCISCO

DEALERS—JOBBER
You will be interested in my proposition on the new tubes with the standard four prong base, packed in attractive individual cartons. **DELIVERIES FOR 60 DAYS NECESSARILY IN ROTATION.** Write today for full details.

18-22½ volts. In addition to its wonderful detector properties, low B battery, quietness in operation, it functions as a tone frequency amplifier and is a free and persistent oscillator for regenerative amplification and CW reception. The pleasure and satisfaction from operating this tube cannot be described. Price.....

\$5.00

Cunningham Type C-301 High Vacuum Amplifier

is the most efficient and stable amplifier ever produced and meets the demand for the Navy type amplifier and regenerative receiver. The exhaust is carried to a high stage, permitting operation at plate voltages from 40 to 100 with increasing amplification. Amplification constant 6.5-8 at 40 volts plate and 8-10 at 100 volts. Filament operates on 6 volts with rheostat. Try C-301 in your multi-stage amplifier with loud speaker. There is a surprise waiting for you. Price.....

\$6.50

CONNECTICUT RADIO

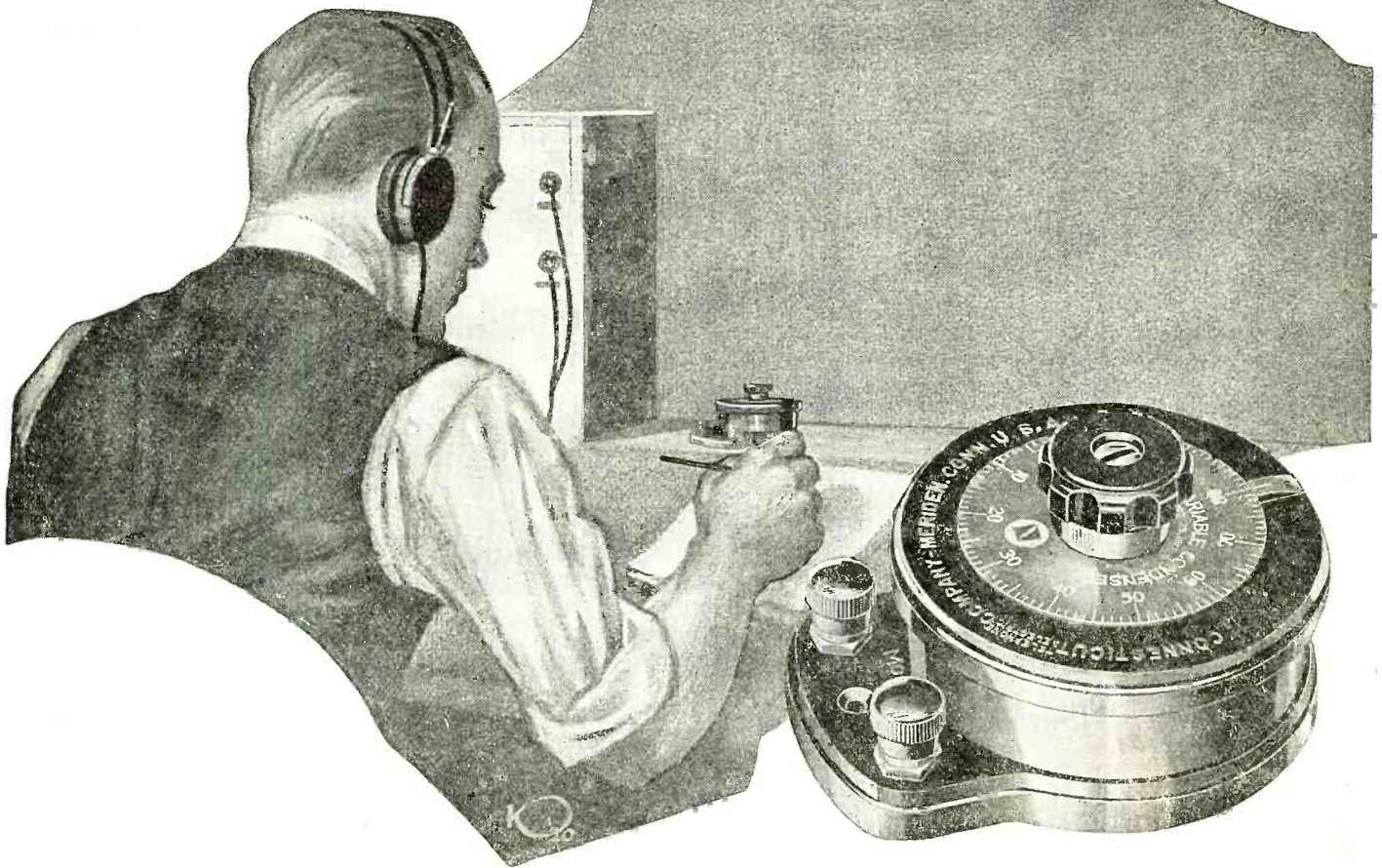
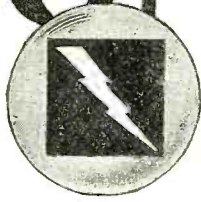

“Signals Can Not Be Beaten”

An Eastern Amateur writes:

“I can truthfully say that your new variable condenser is the best condenser that I have ever used. The signals are loud and clear, and I hear signals which I did not hear before. The condenser is all that you claim it to be.

The variable which I purchased from you I used in the primary circuit where it gave such good results that I decided to get another. This I inserted in the secondary circuit, producing a combination, which for clear, readable signals, cannot be beaten, in my estimation.

Wishing you continued success.”

Send for your copy of the booklet on this new condenser.
It contains much valuable and important information.

Mention Your Dealer's Name

CONNECTICUT TELEPHONE & ELECTRIC COMPANY
Meriden Connecticut

RADIO NEWS

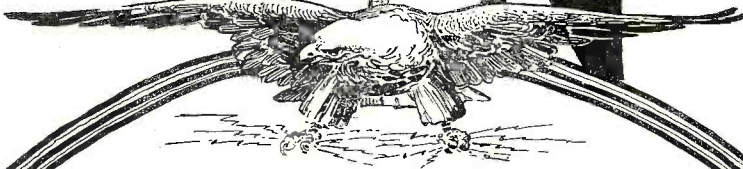

CONTENTS

VOL. 2

FOR JANUARY

NO. 7

	PAGE		PAGE
Editorial.....By H. Gernsback	433	Ideas—Eighth Spasm, By Thos. W. Benson	447
The Electro-Dynamic Receiver.....	434	A. C. for V.T. Filament, By Joseph G. Reed	447
An Efficient Wave-Meter, By Fred A. Burgess	435	The Radio Constructor.....	448
How We Came to Have a V.T. Trans- mitter on the U. S. A. T. Princess Matoika.....By F. M. Daggett	436	High and Low Spark Notes for Amateur Transmitting.....By E. M. Sargent	450
Awards of \$100 Portable Radio Prize Contest	437	Radio Digest	451
Comparison of Modulation Methods in Radio Telephony...By A. S. Blatterman	438	Awards of \$50 Title Prize Contest.....	452
Audio or Radio Frequency Amplifier? By P. L. Welke	441	“Bad” Radio Business, By Arthur H. Lynch	453
A Honeycomb Coil Machine That Works, By Raymond Roof	442	With the Amateurs.....	454
A Regenerative Improvement, By G. N. Garrison	443	Club Gossip	456
A Complete Portable Set, By D. R. Clemons	444	A Phony Phone. By Volney G. Mathison	458
Thermionic Vacuum Tube as Detector. Amplifier and Generator of Electrical Oscillations.....By W. H. Eccles	446	The Mystery of the Damp-Undamp Messages.....By Herbert L. Moulton	459
		Junior Section	460
		Junior Constructor	461
		I-Want-To-Know	462

RADIO NEWS is published on the 25th of each month at 233 Fulton Street, New York. There are 12 numbers per year. Subscription price is \$2.00 a year in U. S. and possessions. Canada and foreign countries, \$2.50 a year. U. S. coin as well as U. S. Stamps accepted (no foreign coins or stamps) Single copies, 20 cents each. A sample copy will be sent gratis on request. Checks and money orders should be drawn to order of EXPERIMENTER PUBLISHING CO., INC. If you should change your address notify us promptly, in order that copies be not mis-carried or lost. No copies sent after expiration. All communications and contributions to this journal should be addressed to: Editor, RADIO NEWS, 233 Fulton Street, New York. Unaccepted contributions cannot be returned unless full postage has been

included. ALL accepted contributions are paid for on publication. A special rate is paid for novel experiments; good photographs accompanying them are highly desirable.

RADIO NEWS, Monthly. Entered as second-class matter June 6th, 1919, at the Post Office at New York, N. Y., under the Act of March 3, 1897, Title registered U. S. Patent Office. Copyright, 1921, by E. P. Co., Inc., New York. The Experimenter Publishing Co., 233 Fulton Street, N. Y., N. Y. The Contents of this magazine are copyrighted and must not be reproduced without giving full credit to the publication.

RADIO NEWS is for sale at all newsstands in the United States and Canada; also at Brentano's, 37 Avenue de l'Opera, Paris.

Published by EXPERIMENTER PUBLISHING CO., INC.

233 Fulton Street, New York City

H. GERNSBACK, President

S. GERNSBACK, Treasurer

R. W. DE MOTT, Secretary

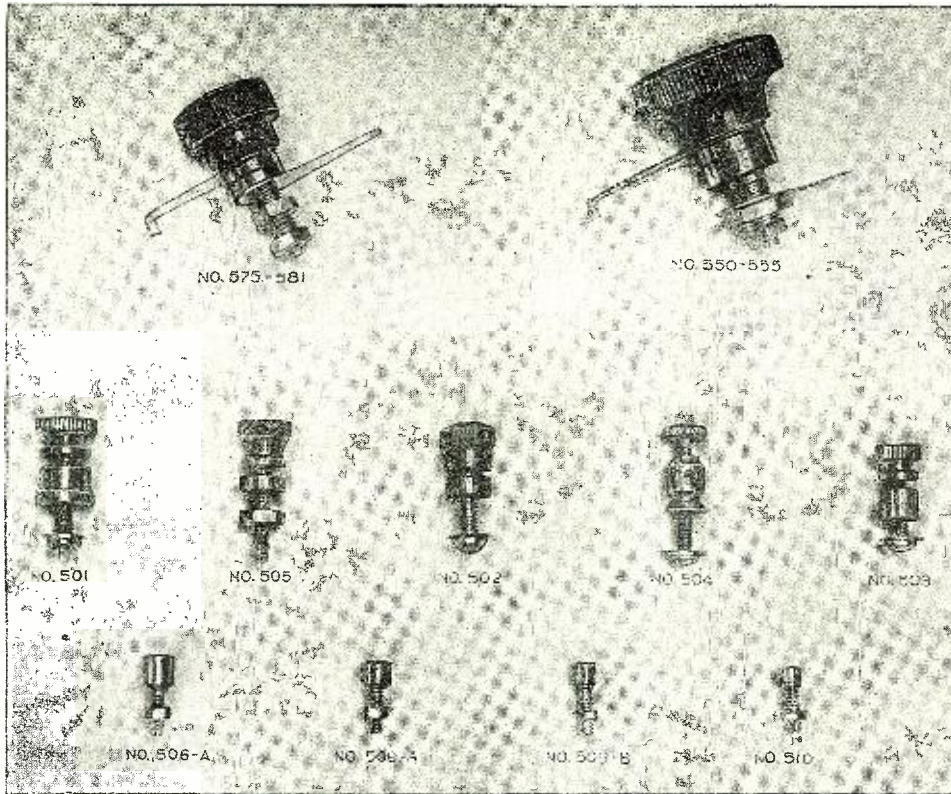

Announcing ABC Standardized Radio Supplies

For over 3 years, the Wireless Equipment Co. has been developing the ABC line of standardized Radio Equipment. Our assortment of standardized small parts, shown above, is now ready. Automatic machines are turning them out by the thousand,—faster, cheaper, and more accurately than ever before.

Every individual part shown above combines quality—*quality* in materials, *quality* in workmanship, *quality* in design—with the big savings of modern, standardized, quantity production. If ABC parts cost a few cents more than some others, it's *entirely* because of the better grade of materials used.

ABC Standard parts are suitable for professional and amateur use, all wave lengths, damp and undamp. All metal parts heavily nickel plated, and finished with a lasting polish. Backed by an unqualified guarantee of complete satisfaction. *Your money's worth or your money back!*

A trial of these small parts will make you anxious to equip your entire station with ABC equipment. If your dealer has not yet secured a stock, order a supply direct from us.

The ABC line is destined to create a sensation. Show that you are up-to-the-minute in radio development by being the first in your district to use ABC parts. Look over the price list and send us your order for all the parts you need, *right now.*

Here are the Prices	
No. 575-581 Switch lever complete. Laminated	\$.60
No. 550-555 Same, large size	.75
No. 501 Binding post	.16
No. 505 Non-detachable head, binding post	.14
No. 502 Binding post	.12
No. 504 and 503 Binding posts	.11
No. 506A Switch point, 1/4" x 1/4"; per doz.	.50
No. 509A Switch point, 1/4" x 3/16"; per doz.	.45
No. 509B Switch point, 3/16" x 3/16"; per doz.	.45
No. 510 Switch point, 3/16" x 1/8"; per doz.	.40
These prices include postage.	

ABC UNITS

Here are two units of the ABC series of Standardized cabinets. The illustration shows the receiving set and combined VT detector and one-step amplifier. Other cabinets of the series are the VT detector alone, the amplifier alone, and the Two-step amplifier. The entire series is of standard size, finish and construction.

This line of sectional cabinets has been purposely designed to save you money. You can start

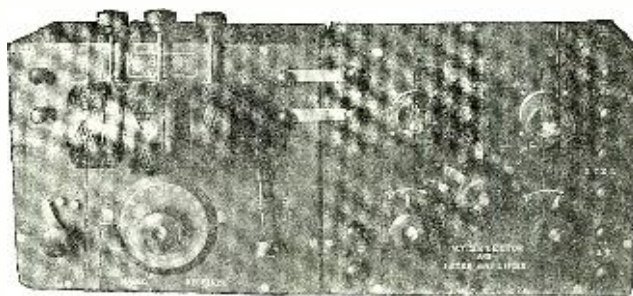

off with just the receiving set—a complete unit. Then you can add on the other cabinets, one at a time, without discarding a bit of your original equipment.

The materials and workmanship in ABC cabinets fully comply with U. S. Navy requirements. At the same time, the standardized design, plus our modern quantity production puts them within reach of every amateur. Write *today* for advance bulletin, describing the entire series in detail.

Professional Radio Equipment at Amateur Prices



WIRELESS EQUIPMENT CO. Inc. Pres. **A. B. Cole**

188 GREENWICH ST. NEW YORK CITY



Our Chicago Store



MONTGOMERY WARD & CO.

SATISFACTION GUARANTEED OR YOUR MONEY BACK

Radio amateurs will no doubt welcome the opportunity that they now have to obtain high grade radio apparatus from this large mail order house. Montgomery, Ward & Company has a record of 50 years of fair dealing with their customers who now number over 5,000,000. This institution was the first to adopt the guarantee of Satisfaction or Your Money Back. This guarantee applies to all radio goods shown on this and the three following pages. Order any of the apparatus on these pages and give it a 5 day examination. If at the end of 5 days it is not what you expected it to be, return it to us and we will promptly return your money together with the transportation charges you have paid.

Large Stocks—Prompt Shipments

We have large stocks and can make prompt shipment upon the receipt of your order. Keep this issue of Radio News and order direct from these pages. Prices are guaranteed against advance until July 1st, 1921. Write your order on any plain piece of paper. We guarantee safe delivery.

Navy Type Receiving Transformer



Improved Model
63R600—A very selective instrument for the more advanced stations. Primary inductance is controlled in steps by units and tens switches. Secondary has 12-point control. Has wave range up to 4,000 meters. Formica panels. Metal parts of brass polished nickel finish. Single silk covered windings. Mahogany finished wood work. Base is 18 inches long, 6 1/2 inches wide. Shipping weight, 25 lbs. **\$17.95**

Arlington Type Receiving Transformer

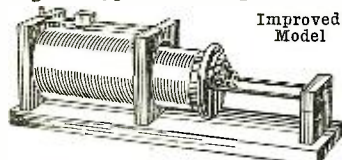

Improved Model
63R601—An efficient high-grade, long wave tuner. Has same winding as our Navy type. Will receive all government time stations such as Arlington and Key West. Works up to 4,000 meters. Primary controlled by slider. Secondary inductance varied by a 12-point switch mounted on Formica, silk covered wire windings. Brass metal parts polished and lacquered. Mahogany finished wood work. Base, 18 inches long, 6 inches wide. Shipping weight, 14 pounds. Price **\$7.90**

Junior Loose Coupler

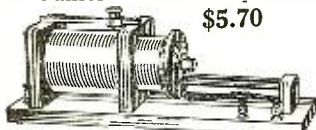

\$5.70
63R5103—A fine instrument for 200 to 600 meter work. Primary controlled with slider, secondary by 5 point switch. Metal parts brass, polished and lacquered. Woodwork mahogany finish. Base 12x3 1/2 in. Ship. wt. 6 pounds. Price **\$5.70**

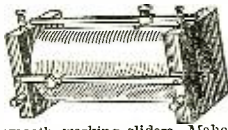

Two Slide Tuning Coil

63R5104 — Machine spaced enameled copper wire winding. Non-shrinkable tube. Control is by means of two smooth working sliders. Mahogany finished end pieces. Range up to 1,000 meters on average antenna. Length, 8 1/2 in. Ship. wt. 4 pounds. Price **\$3.95**

Loading Coil

63R5105—Essentially the same as two slider tuning coil, but has only one slider. Will add about 300M range to any set. Shipping weight, 3 lbs. **\$3.40**

Universal Detector

63R5304—A detector of correct construction. Permanent adjustment. Galena, silicon and other minerals can be used. Moulded base and adjustment knob. Metal parts of brass, polished nickel finish. Tested piece of silicon included. Base size, 2 1/2 x 3 1/2 in. Ship. wt., 1 lb. Price **\$1.88**



Murdock Detector Stand

63R5302—A good low priced detector stand. Will do very satisfactory work. Moulded black composition base. Adjustable cup and contact. Nickel plated binding posts. No crystals included. Size, 2 1/2 x 1 1/2 x 2 in. Shipping weight, 4 oz. Price **70c**

Montgomery Ward & Co.
Satisfaction Guaranteed or Your Money Back

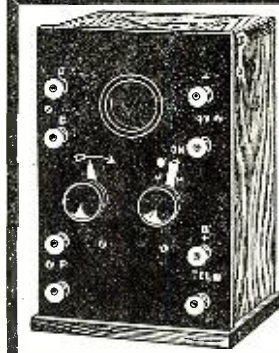

Vacuum Tube Control Detector Cabinet

An efficiently arranged fine looking detector cabinet. The best value and the highest grade instrument we have found. Standard V.T. base mounted on back of panel. V.T. may be observed through window. Filament control rheostat. Grid condenser. Nickel plated binding posts with marked connections. Fine quality cabinet, weathered oak finish, hinged at top so that interior is easily accessible. Bakelite Panel size 7 1/2 x 5 1/4 in. Shipping weight, 6 pounds. **\$12.50**
63R5170—Detector cabinet

Vacuum Tube Amplifier Cabinet

Arranged to work in conjunction with any V.T. detector cabinet. Being of the same size and construction as our special detector cabinet the two make a desirable combination. Standard V.T. base mounted on back of panel. V.T. may be observed through window. Filament control rheostat. Improved amplification transformer. Nickel plated binding posts with marked connections. Fine quality cabinet, weathered oak finish, hinged at top so that interior is easily accessible. Bakelite Panel size 7 1/2 x 5 1/4 in. Ship. wt., 7 lbs. **\$17.95**
63R5172—Amplifier cabinet

Radiotron Vacuum Tube Detector

63R5194—This is a "soft" tube especially suited for detector use and is also an excellent audion frequency amplifier. It produces excellent results in regenerative circuits. Has the familiar hissing point and low B battery potential requirements. Standard four-prong mounting. Shipping weight, 1 lb. **\$5.00**
Price
63R5820—4000 ohm potentiometer graphite. Often used with soft vacuum tubes. Price **\$1.15**



Radiotron Vacuum Tube Amplifier Oscillator

63R5192—A high vacuum amplifier and detector. Requires no critical adjustment. Suitable for amplification and undamped wave reception by the regenerative method. May be used singly for receiving continuous waves or in cascade as a two or more step amplifier. Shipping weight, 1 lb. Price **\$6.50**



Socket for Vacuum Tube

63R5342—Socket is mounted on bakelite sheet. Four binding posts for connections. Screw holes for flat mounting, screws in side of base for panel mounting, permitting either upright or vertical position of tube. Shipping weight, 8 ounces. **\$1.40**
Price



Improved V. T. Socket

63R5343—Improved long flat spring contacts insure positive contact on any standard tube base prongs. Glossy black composition base. Nickel plated tube. Marked screw connections. May be used and wired in any position. Shipping weight, 8 ounces. **\$1.00**
Price



Standard Galena Detector

63R5305—A popular detector. Tested piece of galena is mounted in cup which can be rotated. Crystal contact of phosphor bronze wire coiled and pointed and set on flat spring. Very fine adjustment obtainable with screw. Moulded base and adjustment knob. Base size 3x3 in. Ship. wt., 1 1/4 lbs. Price **\$1.43**

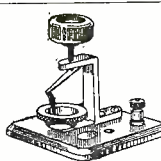

Detector Crystals

Genuine Arlington Tested Minerals. Absolutely the best crystals that can be purchased for any price. All are thoroughly tested and guaranteed. Extremely sensitive. Packed separately in sealed boxes. Shipping weight about 3 ounces.
63R5320—Supersensitive Galena. Per crystal **29c**
63R5322—Supersensitive Silicon. Per crystal **29c**
63R5324—"Radioctite". Per crystal **25c**



Vacuum Tube Control Panel

63R5108—A compact, handy V.T. panel. Standard socket, rheostat, grid condenser, grid leak and binding posts all mounted on moulded bakelite panel. Metal parts polished nickel finish. A high grade, inexpensive instrument that will do as good work as the highest price cabinet. Base size, 3 1/2 x 5 in. Shipping weight, 2 1/4 lbs. **\$6.00**
Price



Variable Condenser for Panel Mounting

63R5173—The best value in high grade variable condensers. Rugged, durable construction. 13 aluminum stationary plates, 12 rotary plates. Overall dimensions 4 1/2 in. high, 3 1/4 in. wide, 3 in. long. Bakelite knob. Pitted cap. .0005 M. F. Shipping weight, 1 pound. Price **\$6.25**



Murdock Variable Condenser, Enclosed Type

63R5175—Murdock No. 367. Polished black composition top and bottom with transparent enclosing cylinder. 22 stationary plates, 21 movable plate. Cap. .001 M.F. Diam. 3 1/8 in. Height, 3 1/4 in. Binding posts and arrow pointer are nickel plated, degree engraved scale. Shipping weight, 2 1/4 lbs. Price **\$4.50**
63R5177—Murdock 368. Same as above but has 12 stationary plates and 11 movable. Capacity, .0005 M.F. Shipping weight, 1 1/2 pounds. Price **\$4.00**



Murdock Panel Type Variable Condenser

63R5179—Twenty-three plate .0005 M.F. capacity. Ruggedly assembled for panel mounting. Complete with mounting screws, knob, pointer, engraved 180 degree scale and anti-capacity handle. 1/4 in. shaft. Any standard knob or dial may be used. Requires space 3 1/2 in. wide; 2 in. deep for mounting. Shipping weight 1 1/2 lbs. **\$3.50**
Murdock No. 3681. Price **\$3.50**
63R5181—Forty-three plates. Capacity .001 M.F. Complete as above. Requires space 3 1/2 in. wide, 2 1/2 in. deep for mounting. Ship. wt., 2 1/2 lbs. **\$4.25**
Murdock No. 3661. Price **\$4.25**



Knocked Down Variable Condenser

Furnished complete but unassembled. Intended for panel mounting and are complete with scale pointer and knob. Formica tops and bases. Shipping weight, 1 1/2 lbs.
63R5183—Capacity, .001 M.F. 41 plates. Price **\$3.20**
63R5185—Capacity, .0005 M.F. 21 Plates. Price **\$2.25**

CHICAGO, ILL. KANSAS CITY, MO.
Send Your Order to House Nearest You

ENTER THE RADIO FIELD

ORDER DIRECT FROM THESE PAGES

The prices shown on these four pages of Montgomery Ward & Co. Radio Apparatus are guaranteed against any advance until July 1st, 1921. Keep this issue of Radio News and order direct from these pages as you need any additional equipment. Write your order on any plain piece of paper, giving article number, and enclose money order or bank draft. Send currency by registered letter only. Add parcel post charges to your remittance. Figure up total weight of apparatus ordered and ask your postmaster what postage will be required. Send your order to our Chicago or Kansas City Store, whichever is nearest you. We guarantee safe delivery.

Combined Detector and Amplifier

This instrument in connection with a set of inductance coils, two variable condensers, batteries and a good aerial will permit of the reception of all classes of radio signals over an extremely broad range. Used in conjunction with our Regenerative set you have a receiving outfit that can only be excelled by adding additional stages of amplification. Detector and amplification tubes mounted inside of cabinet and are provided with rheostat control. Detector provided with grid condenser. High efficiency amplification transformer between detector and amplifier circuit. Jacks are wired in detector and amplifier circuit and a plug supplied for phones permitting use of detector or amplifier as desired. Dull finish bakelite panel, 7 1/4 in. high, 6 3/4 in. wide. High grade weathered oak finish cabinet with hinged top, making interior easily accessible. Binding post connections for batteries and couplers. No tubes, batteries or phones included. Brass metal parts. Binding posts oxidized finish. Shipping weight, 12 pounds.

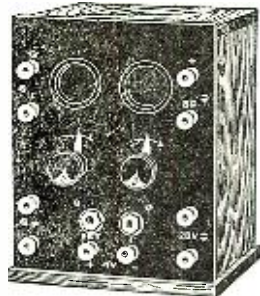

63R612—Price \$28.00

Amplifying Transformer

63R5140—Will positively increase the strength of incoming signals up to twenty times the original audibility. Scientifically designed to work with the vacuum tubes supplied for amateur use. One of the best devices in its class. It is of the iron core type and is supplied with binding posts and lugs for mounting. Height, 2 1/2 in. Shipping weight, 1 pound.



Price \$5.60
63R5141—Same as above but not mounted. Price \$3.90

General Radio Amplifying Transformer



We believe this to be the most efficient, best designed and best constructed amplification transformer on the market. Panel is of bakelite. Binding posts are polished nickel finish. Supports are black enamel finish. Size, 2 1/4 x 2 1/2 x 1 in. Ship. wt., 1 lb.

63R5188—As illustrated. Price \$7.00
63R5190—Same, not mounted, but with supports for mounting. Price \$5.25

"A" Storage Battery

63R398—Six volt, 49 amp. hour storage batteries for filament circuit. This is the highest grade Hercules battery made by the National Carbon Co., and will give long, satisfactory service. Weight, 30 pounds.



Price \$17.50

Vacuum Tube Plate Circuit Battery



Composed of 15 cells in series—22.5 volts. Each cell separately insulated and the whole unit compactly assembled and sealed together. Flexible leads from end cells. Polarity plainly marked.

63R5618—Signal corps standard size, 3 1/4 x 2 x 2 1/2 in. Shipping weight, 2 lbs. Price \$1.20
63R5621—Navy standard, size, 6 1/4 x 4 3/8 in. Shipping weight, 5 lbs. Price \$1.98

Porcelain Base Rheostat

German silver winding on threaded fibre strip imbedded in porcelain base. Smooth easy action. Moulded knobs, 1 1/4 in. diameter. Resistance, 11 ohms. Capacity, 3 amperes. Diameter, 4 inches. Shipping weight, 1 1/2 lb.



63R5313—Front mounted. Price 98c

Panel Mounting Rheostat

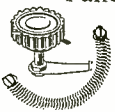

63R5316—An ideal rheostat for filament control. Enameled resistance wire wound on bakelite form. Resistance 5 ohms. Capacity 2 amperes. Complete with knob, shaft, nuts and pointer. Ship. wt. 3 oz.

Price \$1.20
Order direct from these pages. See instructions at top of this page.

Paragon Combination Rheostat

63R5318—For either panel or table mounting. Especially desirable for panel mounting. Requires space only 2 1/2 in. diam. and 1/2 in. deep. Moulded condenser base and knob. Smooth operation. Easy connecting and assembling. Resistance 6 ohm. Capacity 1 1/2 amperes. Shipping weight, 8 oz.



Price \$1.75

Unmounted Honeycomb Inductance Coils



High grade efficient inductance coils at attractive prices. Claimed by many users to be the best on the market. Made firm by varnish impregnation. Shipping weight, 4 to 16 oz. Wave length is in meters with .001 M.F. condenser. Not mounted.

Article Number	Number Turns	Approximate Wave Length Range	Price
63R5470	25	130—250	\$0.50
63R5471	35	180—450	.50
63R5472	50	250—700	.60
63R5473	75	400—900	.60
63R5474	100	500—1,000	.70
63R5475	150	600—1,200	.65
63R5476	200	1,000—2,500	.75
63R5477	300	1,500—4,500	.85
63R5478	400	2,000—6,000	.90
63R5479	600	4,000—10,000	1.15
63R5480	1,000	8,000—15,000	1.60
63R5481	1,250	10,000—20,000	2.90
63R5482	1,500	16,900—25,000	2.50

Mica Grid Condenser

For use in grid circuit of vacuum tube. Cap., .0005 M.F. Weight, 8 and 2 oz.



63R5330—Mounted in mahogany base. Price 65c
63R5331—Unmounted. Price 25c

Century Buzzer

63R5346—Used by the Army and Navy and commercial wireless stations. For adjusting crystal detector. Operates on one or two dry cells. Base is hard rubber with black enameled brass cover. Two thumb screws provide for adjustment of the armature to regulate the tone to desired pitch. Genuine Platinum Contacts. Diameter of base, 2 in. Ship. wt., 6 oz.



Price \$1.65

Test Buzzers



63R5345—Watch case buzzer. Operates on one dry cell. Nickel plated cover and base. 1 inch high, 2 1/2 inches diameter.

Test Buzzer Push Button

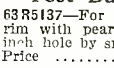

63R5347—For use with test buzzer. Nickel rim with pearl center. Held firmly in 1/2 inch hole by small spring clips. Ship. wt., 4 oz.

Price 19c

Our Kansas City Store



Send for Our Big Catalog

We show a complete line of electrical goods in our New General Catalog. If you are interested in motors either large or small, wiring materials, lamps, transformers, meters, etc., you should have a copy of this new book. In addition to electrical goods it contains a complete line of tools, automobile accessories and merchandise of all kinds which will be of interest to the entire family. A copy will be sent free on request. Kindly mention Radio News.

Murdock No. 55 Head Sets

These sets have given excellent service to thousands of users. Their extra responsive diaphragms, fine quality permanent steel magnets, enameled copper wire windings, Nickel silver adjustable headband, complete with 5-foot cord. Ship. wt., 1 1/2 lbs.



63R5370—Double set, 2000 ohms (total). Price \$4.50
63R5371—Double set, 3000 ohms (total). Price 5.50

Brandes High Grade Receivers

The Brandes line of receivers is the very finest. They are used throughout the world and are famous for their excellent workmanship, durability and extreme sensitiveness. All have the new Brandes type head band, which is comfortable, easily adjusted, very light and will not catch the hair. Fitted with 6-ft. polarity indicating cord. The phones of each set have carefully matched tones. Ship. wt., 2 lbs. per set.

63R5380—Superior type, total res. 2000 ohms. Complete. Wt., 14 oz. Price \$8.00
63R5381—Transatlantic type, total res. 2800 ohms. Complete. Wt., 11 oz. Price \$12.00
63R5382—Navy type, total res. 3000 ohms. Very sensitive. Complete. Wt., 9 oz. Price \$14.00

Receiver Cord

63R5395—Double receiver green mercerized cord, 6 feet long, for use with any standard receiver. Price 95c

Learner's Head Set

63R5383—Scientifically constructed for radio use. Should not be confused with ordinary telephone receivers sometimes furnished. These sets are just the thing for those who wish a low priced sensitive radio head set. Res. 1000 ohms. Ship. wt., about 1 1/4 lbs. Price. \$2.50



Watch Case Receiver

63R5384—Regulation watch case type telephone receiver. Moulded composition case. Bipolar. Resistance, 80 ohms. Ship. wt., 12 oz. Price, each. \$1.05



Fixed Receiver Condenser



A necessity on every receiving set. Used as "stopping" condenser or for shunting across telephones. Moulded composition bases. Nickel plated binding posts. Ship. wt., about 8 oz.

63R5362—Capacity, .01 M. F. Price 90c
63R5364—Capacity, .005 M. F. Price 70c

Knife Switches

Porcelain base switches. Contacts and blades made of heavy copper. Intended for low voltage currents, but can be used on 125 volt current to carry load not over 15 amperes.



63R2684—Single pole, single throw switch. Base, size, 1 1/2 x 3 1/2 in. Ship. wt., 6 oz. Each. 24c

63R2686—Single pole, double throw switch. Base, size, 1 1/2 x 3 1/2 in. Ship. wt., 10 oz. Each. 37c
63R2687—Double pole, single throw switch. Base, size, 2 x 2 1/2 in. Ship. wt., 10 oz. Each. 39c

63R2689—Double pole, double throw switch. Base, size, 2 1/2 x 4 in. Ship. wt., 1 lb. Each. 54c



CHICAGO, ILL.

KANSAS CITY, MO.

Send Your Order to House Nearest You

Montgomery Ward & Co.
Satisfaction Guaranteed or Your Money Back

Our Chicago Store



MONTGOMERY WARD & CO.

ORDER DIRECT FROM THESE PAGES

These prices are guaranteed against any advance until July 1, 1921. It will pay you to keep this issue of Radio News and order from these pages at any time you are in need of additional equipment. Write your order on any plain piece of paper, giving article number and enclose money order or bank draft covering price of apparatus ordered plus parcel post charges. Figure up the total weight of apparatus ordered and ask your postmaster what postage will be required. Send your order to our Chicago or Kansas City Store, whichever is nearest you. Do not send cash without registering letter. We guarantee safe delivery of your order.

Wireless Transformers

\$27.00

Thordarson Type R.
For use on 108 to 115-volt alternating current, 60 cycles. Generally accepted as the standard transformer for amateur transmitting. Provided with adjustable magnetic leakage gap which controls primary input giving a wide range of amperage and permitting easy adjustment to point of resonance. No impedance or choke coil necessary in primary circuit. Ship wt., 35 and 55 lbs.

Art. No.	K. V. A.	Amp.	Sec. Volt	Price
63R630	1/2	1 to 6	10,000	\$27.00
63R632	1	2 1/2 to 14	25,000	45.00

Thordarson Type R. S. Transformer
This type differs from the well known model shown above only in that it does not have the adjustable magnetic shunt. All other features of sturdy, compact construction and correct electrical characteristics are the same. For use on 105 to 120 volt 60 cycle alternating current.

Art. No.	K. V. A.	Sec. Volts	Ship. wt.	Price
63R633	1/2	8,000	15 lbs.	\$15.00
63R634	1	10,000	25 lbs.	20.00
63R635	1	13,000	35 lbs.	30.00

Kick Back Preventer

63R5358—Prevents high frequency surges from discharging back into power line. A necessity when power transformer is supplied from city mains. Two 1000-ohm resistance rods. Mahogany finished base. Connections of strip copper. Ship. wt., 4 lbs. Price..... **\$4.80**

Variable Transmitting Condenser—Oil Immersed

63R620—An oil immersed variable condenser for use with all makes of transformers up to 1 K. W., 25,000 V. Phenol fibre dielectric, corrugated aluminum separators allow circulation of oil to keep down heating. Flat aluminum sheet electrodes with rounded corners. Variable in ten steps of .0009 M. P. each from .0018 M. P. to .009 M. P. Especially designed to prevent corona losses and brush discharge. Oil included. Ship. wt., 35 lbs. Price..... **\$27.00**

Wireless Spark Coils

For use on dry cells or storage batteries. Properly adjusted the half inch coil has a sending range from 2 to 5 miles, the one inch coil 5 to 10 miles. Ship. wt., 8 and 8 lbs.

63R5126	— Half inch coil.....	\$3.95
63R5127	— 1 inch coil.....	5.95

Spark Coil Transmitting Condenser

63R5348—Designed for use with spark coil sets. Dielectric of 5—size, 5x7 photo plates. Mahogany finished case. Permits working on 200 meter wave. Ship. wt., 3 lbs. Price..... **\$1.48**

Murdock Improved Antenna Switch

63R5113 — A large, sturdy well built "change over" switch suitable for use on sets up to 1 K. W. Mahogany finish base. Improved support, copper blades. Fitted with third blade to disconnect receiver when sending. Ship. wt., 2 1/2 pounds. Price..... **\$4.50**

Ground Switch

63R5359—600 volt, 100 ampere double throw single-pole switch on insulating base. For grounding aerial when not in use. Ground wire should be 4 gauge. Ship. wt., 5 lbs. Price..... **\$4.85**

Ground Rod

63R1081—Iron Ground Rod; length, 6 ft. Heavily galvanized. A ground rod is necessary with every Radio outfit to insure a perfect ground contact. Shipping weight, 4 lbs. Price each... **43c**

\$34.95 Combined Detector and Two Stage Amplifier

This instrument with the proper accessory instruments has the broadest possible range. So sensitive is it that even with an indoor aerial such as our loop antenna 63R650 messages may be received from stations hundreds of miles distant. Combined with our Regenerative set and two variable condensers and the proper couplers and loaders with a good outdoor aerial, its range is increased to equal the best commercial stations. Has one detector and two amplifier circuits. Standard tube sockets, grid condenser in detector circuit, two amplification transformers, three jacks and one plug so that any desired circuit may be used. Bakelite panel 7 1/2 in. high, 8 3/4 in. wide. High grade weathered oak finish cabinet with hinged top making interior easily accessible. Binding post connections for batteries and couplers. Binding posts black oxidized finish. No tubes, batteries or phones included. Shipping weight, 18 lbs. 63R615—Price..... **\$34.95**

Universal Spark Gap Motor

63R5695—A rugged high grade motor for spark gaps, running sewing machines, fans, small lathes, buff-fers, emery wheels, etc. Running idle will make 8,000 R.P.M. Will make about 4,500 R.P.M. with electrode shown below. Will operate on 100-125-volt A. C. or D. C. current. Black enamel finish. Height, over all, 5 1/2 in. 1/4 in. shaft extends 3/8 in. Will develop about 1/20 H. P. Supplied with 1-in. grooved pulley. Ship. wt., 8 lbs. Price..... **\$9.50**

Spark Gap Electrodes

63R5625—Saw tooth rotor, 5/8 in. diam., of machined cast aluminum with bakelite center and brass bushing to fit 1/4-inch shaft. Two adjustable stationary electrodes. This set together with universal motor listed above, mounted on a substantial base will make a high grade rotary spark gap. Ship. wt., 1 1/2 lbs. Price, set..... **\$4.50**

Clear Tone Rotary Spark Gap

63R5167—Specially made for us by one of the leading manufacturers. A high grade enclosed motor driven gap. Improved saw tooth cast aluminum accurately machined 5 3/8 in. diam. 16 point rotor with bakelite center. Adjustable well insulated stationary electrodes. Cast aluminum enclosing case diam. 8 inches, depth 3 inches. High grade high speed 110 volt universal motor mounted on case. Smooth running and reliable in either horizontal or vertical position. Ship. wt., 7 lbs. Price..... **\$25.50**

63R5168—Same as above, without motor but with pulley for driving. Price..... **\$19.50**

Zinc Spark Gap

63R5350—For use with spark coil transmitters. Base is moulded composition. Metal parts are plated and polished. Can be used with coils up to 4 inches. Ship. wt., 2 pounds. Price..... **88c**

Radiator Spark Gap

63R5351—Micrometer adjustment. Electrodes of zinc. Cooling vanes aluminum. Metal parts nickel plated. Base glazed porcelain. Will handle over 1 K. W. Weight, 2 lbs. **\$2.33**

For a Complete Line of Electrical Goods Write for our Large General Catalog

Double Action Wireless Key

63R5356—Double action which makes for speed. Will improve your sending and lends individuality. Large standards, formica knob, heavy silver contacts suitable for use up to 2 K. W. Mounted on durable and heavy formica base. Metal parts nickel plated. Ship. wt. 1 1/2 lbs. Price..... **\$4.65**

Standard Wireless Key

63R5352—A high grade key made of heavy lacquered brass. Large hardened contact points. Ship. wt. 1 lb. Price... **\$3.48**

Steel Lever Keys

Shipping wt., 14 oz.

63R1739—Leg Key with legs to go through table or desk. Price, each.... **\$2.15**

63R1741—Legless Key to screw to top of table or desk. Price each..... **\$2.10**

Commercial Type Oscillation Transformer

\$16.95

63R648—Designed to give wave ranges both above and below 200 meters. Solid copper windings on "Formica" supports 10 1/2 in. diam. primary of six turns No. 3 wire 6 1/2 in. diam., secondary of twelve turns No. 3 wire. Mahogany finished woodwork. Two helix clips included. Ship. wt., 26 pounds. Price..... **\$16.95**

Murdock Oscillation Transformer

63R5155—Permits sharp tuning on 200 meter wave. Can be used on sets up to 1 K. W. Primary and Secondary windings of edge-wise wound copper ribbon. Coupling varied by hinge. Shipping weight., 8 lbs. Price..... **\$5.00**

Loop Antenna

\$6.60

63R650—Will receive messages from stations 300 miles distant, and much farther under favorable conditions. Placed inside of house doing away with danger from lightning and the necessity of cutting holes for lead-in wires. Wave length 200 to 2500 meters. Can also be used as direction finder and will tune out stations not wanted. Comes knocked down with all the necessary wire for winding. Assembles easily. Height 36 in. Sides 32 in. Ship. wt., 12 lbs. Price..... **\$6.60**

Montgomery Ward & Co.
Satisfaction Guaranteed or Your Money Back

CHICAGO, ILL.

KANSAS CITY, MO.

Send Your Order to House Nearest You

RADIO APPARATUS

SPECIAL VALUE FOR JANUARY

Vacuum Tube Control Panel

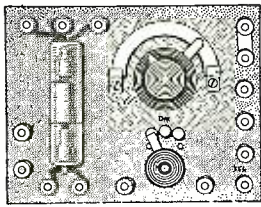

This high grade panel is especially designed for use with the tron type of vacuum tube. It is the most convenient and efficient panel we have seen. Formica panel size 5 1/2 x 7 1/2 inches. Metal parts polished and nickel plated. Any V.T. circuit can be used. Wiring diagram and instructions furnished. Binding post connections for "A" and "B" batteries, tube, phones, tickler and secondary coils. Switch for filament. Potentiometer and rheostat controls cleverly and conveniently arranged. 4000 ohm graphite condenser. High grade rheostat. Mica grid condenser. Wiring all enclosed in spaghetti. Mounting brackets for convenient attaching to table or cabinet. Ship. wt., 4 lbs. **63R5106**—Specially priced for January at.....\$9.95 **63R5197**—Audiotron Vacuum Tube. A very sensitive detector. Guaranteed against imperfections. Double filament. Ship. wt., 6 oz. Specially priced during January at.....\$4.75

Short Wave Long Distance Regenerator Receiver \$33.95

This instrument makes possible the reception of messages to which other types of apparatus will not respond. The range is from 180 to 600 meters and by the addition of external loaders, such as the inductance coils listed on the opposite page, this range may be raised as desired. Properly handled, signals may be read from stations at extreme distances or through heavy static and interference. The antenna and closed circuits are inductively coupled and the coupling is variable. Regeneration is obtained by tuning both the grid and plate circuits to resonance with the incoming signal. Highest efficiency and amplifications are obtained by reducing capacity and resistance in circuits to absolute minimum and best regenerative effects are secured by use of properly designed variometers.

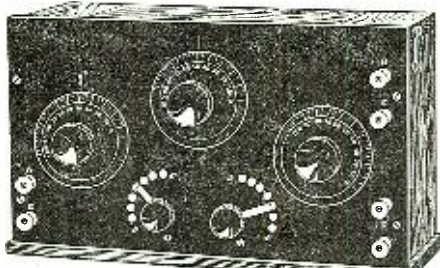

The inductive coupler consists of a primary, the inductance of which is varied by two seven point switches, and a rotating secondary by means of which arrangement very fine tuning is possible. Coupler and both grid and plate circuit variometers are fitted with high grade knobs and indicating dials. A very compact and easily portable instrument. Graduated bakelite panel size 7 1/4 x 13 1/4 in. Fine cabinet weathered oak finish, 5 inches deep. Metal parts brass, black oxidized finish. Ship. wt., 26 lbs.

63R610—Regenerative Receiver. Price.....\$33.95

Indicating Dials and Knobs



Marconi New Reg. Ideal

Made of moulded black composition. Edges of dials are beveled, radial lines and figures are engraved in and filled with contrasting brilliant white enamel 3/16 in. thick.

- 63R5655**—3-inch Dial only. Price.....**69c**
- 63R5657**—3-inch dial with 1 1/2 in. government bakelite knob. Price.....**\$1.14**
- 63R5659**—3 1/2 in. dial only. Price.....**98c**
- 63R5661**—3 1/2 in. dial with 1 1/2 in. government bakelite knob. Price.....**\$1.48**

Black Composition Knobs

- Ship. wt., 4 oz. each. Per doz. 1 1/4 lbs.
- 63R5665**—Marconi style 1 1/4 in. diam. Hole for 3/16 in. rod. Each. 15c Per dozen.....**\$1.18**
- 63R5667**—Marconi style 2 1/4 in. diam. Hole for 3/16 in. rod. Each. 23c Per dozen.....**\$2.48**

New government style. Has brass bushing for 10/32 thread and two holes for stay pins.

- 63R5669**—Diam. 1 inch. Each 12c Dozen.....**\$1.30**
- 63R5671**—Diam. 1-5/16 inch. Each.....15c Dozen.....**\$1.58**

- 63R5673**—Regulation 1 1/2-inch knob with 8/32 bushing. Each.....11c Dozen.....**\$1.08**
- 63R5675**—Ideal 1 3/4-inch knob metal bushing for 3/16 rod with set screw. Each.....23c Dozen.....**\$2.65**

Binding Posts and Switch Points

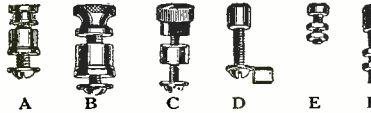

Made of brass, nickel-plated. Binding posts have 5/8 in. long 6/32 screws with washers. Switch points have 5/8 in. screws or shanks threaded 6/32. Ship. wt., per doz., 12 oz.

- 63R5636**—Binding Post "A." Length. 3/4 in. Each.....10c Dozen.....**\$1.08**
- 63R5640**—Binding Post "B." Length 1-3/16 in. Each.....12c Dozen.....**\$1.28**
- 63R5644**—Binding Post "C." With bakelite knob. Each.....12c Dozen.....**\$1.38**
- 63R5646**—Switch Point "D." 1/4 x 1/4 head with soldering lug. Per dozen.....40c
- 63R5648**—Switch Point "E." Head 1/4 in. diam. 1/2 in. high with 2 nuts. Dozen.....45c
- 63R5650**—Switch Point "F." Head 1/4 x 1/4 with two nuts. Dozen.....48c

Grade M Formica Panels

Black sheets. Both sides polished. Waterproof, strong, lasting. Ship. wt., 2 to 8 lbs. Size given is in inches.

- 63R5688**—7x 9 1/4 Price.....**\$0.69**
- 63R5690**—14x 18 1/4 Price.....2.45
- 63R5692**—7x 9 3/16 Price.....1.05
- 63R5694**—14x 18 3/16 Price.....3.90
- 63R5696**—7x 9 1/2 Price.....1.37
- 63R5698**—14x 18 1/2 Price.....5.25



Variometer

63R5640—This is the same high grade variometer that is used in our Regenerative set. With two variometers, a loose coupler and the proper binding posts, dials, knobs, etc., a regenerative set may be constructed at a very low cost. Can also be used separately for grid and plate tuning. Designed for very low dielectric losses and maximum range of inductance. Rotating element contacts made through 1/4 in. shaft so that ball may be continuously rotated without breaking connection. Ship. wt., 2 1/2 pounds. Price.....**\$4.95**

Loose Coupler

63R5642—The same high grade loose coupler used in our Regenerative set. With a loose coupler, two variometers and the proper binding posts, dials, knobs, etc., a regenerative set may be constructed at a very low cost. Can also be used separately. Primary has seven taps which can be connected up to vary inductance. Secondary rotates. Connections are made through shaft. Ship. wt., 3 1/2 pounds. Price.....**\$5.95**

Electrode Insulators

Electrode insulators are the standard in the wireless field. They stand up under all conditions met with. Eyes are wrought iron galvanized. Ship. wt., 1/2 to 2 1/2 lbs.

Article No.	Dia. In.	Lgth. Or. all In.	Strgth Lbs.	Elec. Value Dry Volt	Price Rain
63R5630	2 1/4	3 1/4	250	40,000	25,000 36c
63R5631	1 1/2	4	1,000	40,000	15,000 43c
63R5632	1 1/2	10 1/2	1,000	30,000	50,000 82c

Electrode Wall Insulators

63R5634—Special Wall insulator for lead in wires. Has hole through body for wire. Body diam., 2 in. Length over all, 5-9/16 in. Ship. wt., 1 lb. Price.....**96c**

Porcelain Strain Insulator

63R5628—Made of brown glazed porcelain. A strong rugged insulator. Deep screw ribs. Smooth holed heavy ends. Ship. wt., 6 ounces. Each.....7c Dozen.....**79c**

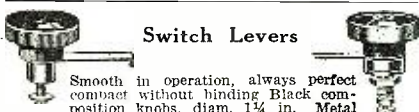

Switch Levers

Smooth in operation, always perfect compact without binding Black composition knobs, diam. 1 1/4 in. Metal parts of brass nickel-plated. Ship. wt., 4 oz.

- 63R5651**—Complete knob, laminated lever and screw permitting mounting on panels not over 1/2 inch thick. Each.. **46c**
- 63R5653**—Complete knob, spring lever, shaft, two lock nuts and bushing for panels up to 3/4 inch thick. Each.. **49c**

Our Kansas City Store



Magnet Wire

For repairing motors, other electrical apparatus, experiment work, etc. One piece only one spool. Wire is standard B and S gauge. Insulation and wire both perfect and uniform. Supplied only on weight spools given.



Double Cotton Covered Magnet Wire			Belden Enameled Magnet Wire		
Order by Art. Number	Price	Gauge	Order by Art. Number	Price	Gauge
63R1350			63R1400		
4 oz. Spool	\$0.79	16	4 oz. Spool	\$0.63	16
.....	.89	1865	18
.....	1.05	2081	20
.....	.78	2283	22
.....	.92	2496	24
.....	1.05	26	1.02	26
.....	1.25	28	1.06	28
.....	1.48	30	1.20	30
.....	1.78	32	1.25	32
.....	1.98	36	1.48	36

New Code, Rubber Covered Wire, Single Braid

Solid conductor copper wire, insulated with rubber compound over which is one cotton saturated braid. Ship. wt., 3 and 13 lbs. per 100 ft. Sold only in lengths listed.

- 63R3015**—Size 14. Price for 25 ft.....**\$0.38**
- Price for 100 ft.....**1.40** Price for 500 ft.....**\$4.85**
- 63R3032**—Size 6. Price for 10 ft.....**69c**
- Per 25 ft.....**\$1.73** Per 100 ft.....**\$5.80**

New Code Twisted Pair Cotton Lamp Cord

Two conductor, twisted New Code Lamp Cord. Conductors consist of fine copper wire strands twisted together. Covering is of fine quality interwoven yellow and green cotton. Ship. wt., 6 lbs. per 100 ft. Sold only in lengths listed.

- 63R3175**—Size 18. Price for 10 ft.....**30c**
- Per 25 ft.....**69c** Per 100 ft.....**\$2.60**

Porcelain Tubes

Un glazed Porcelain Tubes. 5/16 in. inside, 9/16 in. outside. Length given is from underhead to end. Ship. wt., per dozen, 1 to 2 lbs.

- 63R3902**—Length 3 in. Per dozen.....**\$0.22**
- 63R3906**—Length 6 in. Per dozen.....**.43**
- 63R3908**—Length 8 in. Per dozen.....**.70**

Un glazed Porcelain Cleats

Take No. 10 or smaller wires. Have 2 1/2 in. wire centers. Ship. wt. per dozen pair, 3 lbs.

- 63R3923**—2 wire cleats. Price per dozen.....**37c**

Solid Porcelain Knobs

New Code No. 5 1/2 solid porcelain knob. Height, 1-9/16 in. Diam., 1 1/4 in. Hole, 3/4 in. Groove, 5/16 in. Ship. wt., per doz., 1 1/2 lbs.

- 63R3927**—Per doz.....**\$0.30**
- No. 4 solid porcelain Knob. Height, 1-11/16 in. Diam., 1 1/2 in. Hole, 3/4 in. Groove, 3/4 in. Ship. wt., per doz., 2 lbs.
- 63R3929**—Per doz.....**\$0.40**

Porcelain Entrance Switch

National Electric Code Standard Porcelain Base Entrance Switch or main line cut-out switch. Takes plug fuses. Capacity, 125 volt, 30-amperes. **63R4305**—Two-pole switch. Ship. wt., 1 1/2 lbs. Base size, 3 1/4 x 5 1/4 in.

Price, each.....**80c**

Antenna and Copper Wire

Supplied only in size coils listed. **63R5150**—Aerial cable. Composed of seven strands No. 22 B & S. gauge has drawn copper wire. Ship. wt., 6 lbs. per 100 feet.

- 50 feet, 58c
- 100 feet, 94c
- 500 feet, **\$3.95**
- 63R5151**—Bare copper wire No. 14 gauge. 50 feet, 29c
- 100 feet, 47c
- 500 feet, **\$1.90**
- 63R5152**—Bare copper wire No. 12 gauge. 50 feet, 49c
- 100 feet, 77c
- 500 feet, **\$3.10**

A high grade Hardened Steel Plier. Used a great deal on all electrical work. Handy around any work shop. Ship. weight, 6 oz.

- 63R5802**—6-inch Sharp Nose Plier. Price.....**\$1.49**

Best Hardened Tool Steel Diagonal Jaw Side-cutting Nipper. This tool will do perfectly the work for which it is intended. Length, 5 in. Ship. wt., 4 oz.

- 63R5808**—Diagonal Jaw Pliers. Price, **\$1.53**

CHICAGO, ILL.

KANSAS CITY, MO.

Send Your Order to House Nearest You

Montgomery Ward Co.
Satisfaction Guarantee or Your Money Back



The Recognized Symbol of Superior Performance

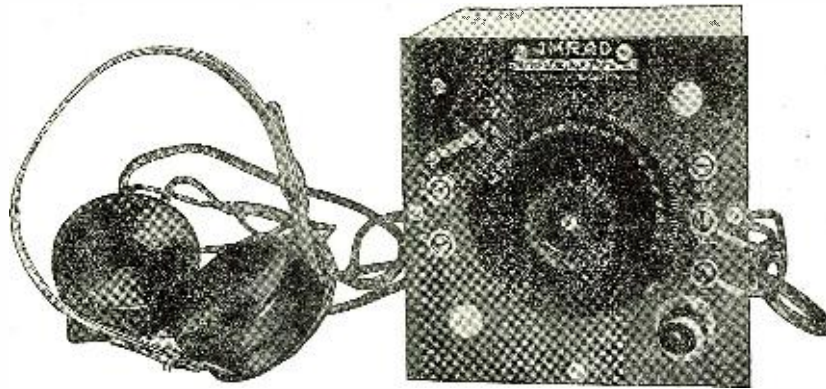

You Can't Go Wrong

in getting this new complete receiving equipment. For reasons of good taste we rarely indulge in superlatives in our advertising, but after very thorough trial we unhesitatingly suggest that the new Amrad Receiving Set, illustrated above, is the most compact, convenient and efficient apparatus ever offered.

Anyone can operate it with excellent results. Anyone able to use a few simple tools can in an hour erect a complete station and actually hear radio telephone and telegraph messages. This wonderful little set is not an "electrical toy"; it is a high-grade commercial product—Amrad made—yet available at a popular price. Rated range 100 miles. Can receive up to 500 miles under favorable conditions.

Nothing to get out of order. Can be carried in your suit case—size only 5" x 5" x 7". No batteries to charge or replace. Elaborate aerial not necessary.

Three wavelength ranges—180 meters minimum, 750 meters maximum with 60 foot aerial. Need never be discarded. May be combined with Amrad Units, illustrated below, as user elaborates his Set.

Really, you'll have to inspect this complete equipment at your dealer's to appreciate it. If he can't help you, write us.

PRICES

Amrad Crystal Receiver, as illustrated, \$23.50.
 Double 2000 ohm Murdock telephone set, \$4.50 extra.
 100' Antenna and Ground Equipment, \$12.00 extra.

Other New Amrad Receiving Units

Amrad Variometers, Vario-Couplers, Variable Condensers, VT Detectors and VT Amplifiers are the sensation of the Season. Ten different models, all of standardized design, construction and appearance. Each conforms perfectly to the Amrad Unit System. If your dealer can't show you samples or supply descriptive literature, send us his name and we will forward our complete catalog free of charge.



Amrad Coupler
\$17.50



Amrad Variometer
\$14.50



Amrad VT Detector
\$15.00

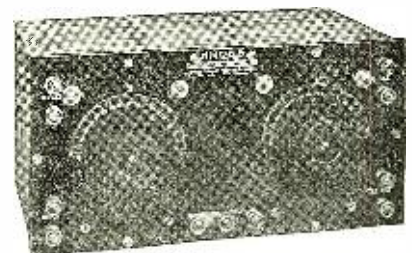

Amrad VT 2-Stage Amplifier
\$39.50

AMERICAN RADIO AND RESEARCH CORPORATION

15 Park Row
New York

Address all Communications
to New York Office

Factory and Laboratory
Medford Hillside, Mass.



RADIO NEWS

H. GERNSBACK—EDITOR
ROBERT E. LACAULT—ASSOCIATE EDITOR

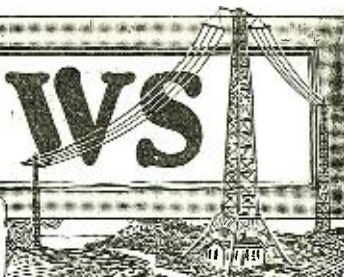

Vol. 2

JANUARY, 1921

No. 7

SULPHUR

ONE of the least known materials with which the radio experimenter is acquainted undoubtedly is sulphur. It is, however, a material that deserves to be known very much better by the radio fraternity and the writer has thought it to be of sufficient importance to write an editorial about it, in order to bring it into greater prominence.

Sulphur is a non-metallic element, probably known by everyone. Its specific gravity is 2.03. Its melting point lies at about 239 degrees Fahrenheit, which melting point varies somewhat in the different grades. Sulphur is one of the three very best insulators known as the following list will show:

RELATIVE RESISTANCES			
Paper	1.—	Wood	1,000
Celluloid	1.6	Rubber (soft)	4,200 to 28,000
Mica	8 to 168	Paraffine	4,800 to 680,000
Bakelite	20	Shellac	7,000
Glass	132 to 400	SULPHUR	14,000 to 70,000
Fiber	200 to 1,360	Stearic Acid	30,000 to 180,000
Gutta Percha	800	Ebonite	80,000 to 560,000

Its inductive capacity can be best appreciated by glancing at the following list:

Glass	6.5 to 10	Paraffine	1.9
Shellac	2.9 to 3.7	Carbonic Acid	1.000
SULPHUR	2.8 to 3.2	Air	1.
Ebonite	2.7	Hydrogen999
India Rubber	2.34	Vacuum94
Petroleum	2.05		

From this it will be seen that with air taken as 1, sulphur has a value three times as high. This immediately suggests a new use for radio, which to the writer's knowledge has not been mentioned in print before.

Why not use sulphur in transmitting condensers? You will note that it ranks next to glass as an available material, but glass we all know breaks easily and once a glass condenser is pierced, it is gone for good. Not so with sulphur. If we space metallic plates in a wooden case, and pour sulphur in the box, we will have an excellent condenser. Of high importance it is, to note that such a condenser will be self-healing, similar to an oil condenser, with the difference that sulphur has a very much higher inductive capacity. Then the minute such a condenser becomes punctured, the heat of the spark melts the sulphur, which has a melting point that is not so exceedingly high, in contrast to glass or India rubber, etc. Upon cooling, the puncture will be healed, due to the melting of the sulphur, and the condenser will be in good condition again, just as good as new.

In his college days in Europe the writer had much experience with sulphur as a first-class insulator; as a matter of fact, most European scientists use sulphur to a very much larger extent than we do here. Sulphur can be melted easily, and can be cast into practically any shape required. Simple wood moulds can be made by the experimenter, and the melted sulphur run into the forms without trouble. The sulphur soon becomes solid, and can be easily removed from the moulds. If there is a tendency to stick, the inside of the moulds should first be rubbed with ordinary talcum powder.

Why don't amateur radio experimenters make their small switchboards of sulphur? Here is a simple wrinkle. Mount all your metal pieces, switchpoints, etc., on a heavy piece of cardboard. Invert the cardboard with the metal parts and lay face downwards upon a marble or metal surface, which should be slightly warmed. Rub the surface with talcum powder. Then put wooden cleats around the cardboard to make sure that the melted sulphur will not run all over the slab. Then pour the sulphur, and you will have a neat panel in which the switchpoints and other metal parts are embedded and come flush with the sulphur top. The writer has made some panels of this kind as big as 12 by 8 inches in dimension, the finished panel being about 1/2 inch thick. The yellow sulphur color is not at all displeasing to the eye, but should it be objected to, the sulphur can be mixed with some *non-conductive* black pigment and the panel will then of course, be black. A very fine aerial insulator can be made of sulphur simply by using two screw-eyes in a wooden mould. Then by casting the sulphur between and around the screw-eyes, we can form not only cheap, but very high grade aerial insulators, better and cheaper in many respects than those upon the market. It will be found that sulphur is quite strong mechanically and does not collect moisture easily. It sheds water like the proverbial duck.

A very fine insulating substance with which the writer experimented some years ago was made by mixing sulphur with ground mica which can be secured from many large chemical houses. A very fine and mechanically strong insulating substance results from this.

The writer has outlined above only a few uses for sulphur, with an idea to encourage the use of this useful substance for radio. Many other uses will undoubtedly suggest themselves to the reader immediately.

H. GERNSBACK.

RADIO BILL S4038

SENATOR POINDEXTER introduced the above bill March 8, 1920, in the Senate and this bill was referred to the Committee on Naval Affairs.

This bill which in many respects is harmless and in a few instances, if passed, would seriously hamper us amateurs, was carefully studied by us the minute it appeared. Private advice, expert advice, as well as our own opinion, made it seem certain that this bill never had a chance to become a law in its original form.

Of course we watched the bill carefully thru all its phases, and very recent information from our Washington representatives makes it appear certain that this bill will not come up for some time to come. No further hearings have been arranged for by the Committee. There were hearings on this bill last Spring, but since that time nothing of importance has occurred.

It has been the policy of the editor not to stir up the amateurs and make them write letters to their Senators and Representatives unless there was actual danger that certain bills might become law. We have always felt that if real danger existed, an S. O. S. to the amateur fraternity was in order.

We were therefore dismayed that in some quarters very zealous but misdirected efforts were converged upon the amateurs, stirring them up to no good purpose. It is the old story of yelling wolf when there is no wolf in sight. Then when the danger really does come, the appeal falls upon deaf ears. Statesmen in Washington do not like to be bothered, and stirred up every little while by busybodies, when no real danger is threatening the amateurs.

The amateur fraternity can rest assured that whenever real danger threatens, they will be advised quickly and effectively.

The Electro-Dynamic Receiver

EVER since Mankind began, the individual has endeavored to voice his own opinions to humanity gathered about him. The human voice in itself proved inadequate for his purpose—so the megafone was invented and adopted as a great help in the art of public speaking.

But the megafone merely directed and concentrated the volume of the human voice. *It did not amplify.* With the invention of the electric microfone it may be stated, the first crude step was taken toward the electric amplification of sounds. A relay action is incorporated in the microfone whereby electrical energy is released by the impingement of sound waves upon the diaphragm. For many years, the microfone was incorporated in apparatus—connected to telephone receivers and called "loud speakers", but the results were little, if any, better than the volume of the unaided human voice. The reason for this must be found in the telephone receivers, which at that time were so constructed that they could not transform sufficient electrical energy into sound waves.

In 1912 two engineers, Messrs. E. S. Pridham and P. L. Jensen, were experimenting on the rapid recording of radio signals at a small laboratory in California. During their research they discovered a new and more powerful receiver. This receiver at once exhibited the phenomenon of being able to transform voice current into sound waves with a ratio proportionate to the amount of voice current supplied to it. This was the electro-dynamic receiver and gave forth sound exactly as current was put into it with practically no limit except for the electrical design of the windings.

The ordinary telephone receiver such as used on our fones for radio and line communication, operates on the *electro magnetic* principle. The voice current passes thru a winding on a permanent magnet, changing its flux intensity and consequently its pull on a diaphragm placed directly over the pole pieces. Its weakness lies in the fact that if the diaphragm is placed at any distance away from the poles of the magnet, the magnetic effect is greatly lessened, and if placed too close, the diaphragm will hit the pole pieces. A compromise position is selected whereby the diaphragm is placed at such a distance away from the poles to allow it some motion be-

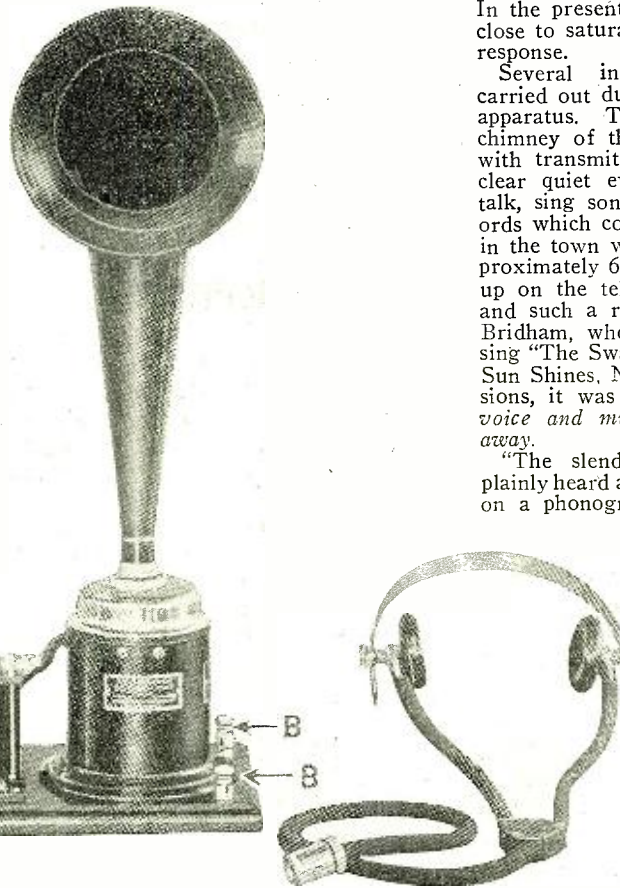

Fig. 3.
Photograph of the New Loud Talking Machine Which Amplifies Weak Signals to Such a Volume That They Can Be Heard by a Whole Audience a Great Distance From the Receiver.

fore hitting the poles and yet near enough to get a fair magnetic pull. Another weakness is that the diaphragm is under tension always and has to be made exceedingly stiff to resist this constant pull. All types of receivers using the electro-magnetic principle will give forth sound proportionate to their input only up to a certain point and then the diaphragm will hit the pole pieces. (See Figure 1.)

In the loud talker described here the principle is *electro-dynamic* and the diaphragm is in no way directly concerned with the magnetic flux. A small coil of fine wire is placed in a circular air gap between the poles of a very powerful electro magnet, and this coil attached to the diaphragm (Fig. 2). The magnetic flux across this air gap is constant, and the current is sent thru the small coil. Whenever a current flows thru the coil it is either attracted or repelled, according to the direction of flow thru the little coil, and the motion thereupon transmitted to the diaphragm. There are no pole pieces to interfere with motion, which may be as large as the elastic limit of the diaphragm. A large horn is attached immediately above the diaphragm, and the air column in that horn moved in accordance with the vibrations of the diaphragm.

This electro-dynamic receiver will then give off enormous sound volume without limit except for input. There are several interesting phenomena connected with it. A weight of ten pounds may be placed directly on the diaphragm and it will still vibrate. No vibration of electro-magnetic receiver can support such a weight for only four ounces will stop any of them. There is another action whereby the volume of sound is increased for the same voice current input if the magnetic field is increased.

In the present instrument the field is very close to saturation so as to give maximum response.

Several interesting experiments were carried out during the development of this apparatus. The machine was put on the chimney of the laboratory and hooked up with transmitters and a phonograph. On clear quiet evenings the inventors would talk, sing songs and play phonograph records which could be heard by every person in the town which had a population of approximately 6,000. Many people would call up on the telephone and request that such and such a record be played, or that Mr. Bridham, who has a splendid tenor voice, sing "The Swanee River" or "Wait 'Till the Sun Shines, Nellie." On one of these occasions, it was authentically found that *the voice and music were heard eight miles away.*

"The slender tone of a single violin plainly heard a mile away; Tetrizzini's voice on a phonograph record resounding from end to end of the vast stadium; the words of Thos. W. Hickey, reading Lincoln's Gettysburg Address, reverberating thru the air like the roar of a giant; a piano solo resembling the chimes of a Westminster Abbey, played by the Colossus of Rhodes" — these things have been made possible by the new invention.

Among the many electrical inventions which have come to play such an intimate part in our everyday life, one, the three-electrode vacuum tube, stands out from all others in its peculiar adaptations to electrical advancement. It has been put to many uses; as a detector of wireless signals, as an oscillator or generator of wireless waves and as an amplifier of weak electrical impulses. As an amplifier it has reached out and obtained an important and far reaching hold upon present day progress.

It is the vacuum tube that makes possible transcontinental telephony. Interposed in the line are "repeaters" which are merely banks of little vacuum tubes which catch

(Continued on page 487)

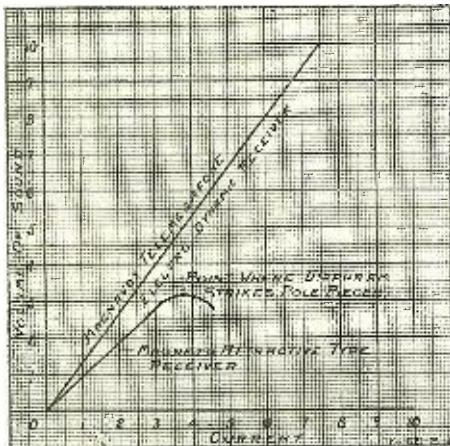

Comparison of Amplitude Curves of the Diaphragm in a Telephone Receiver and in a Loud Speaker of the New Type.

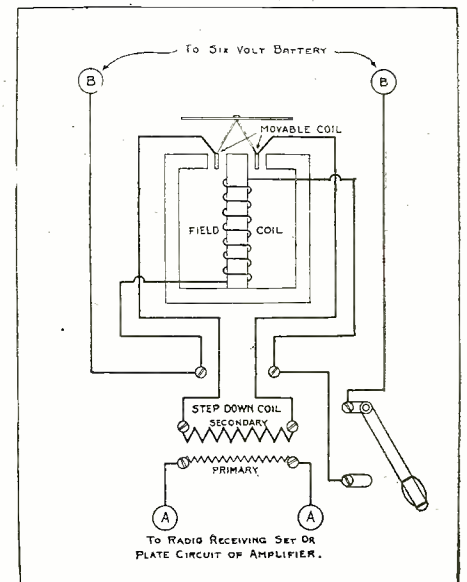
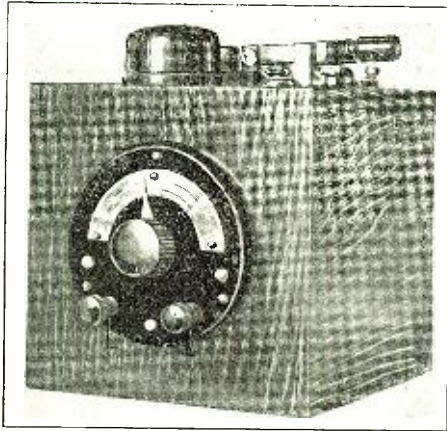

Diagram of the New Telemegefone, Showing the Functioning Principle of This Instrument. Note the Coil Fixed to the Diaphragm.

Illustrations courtesy the Magnavox Co.

An Efficient Wave-Meter

By FRED A. BURGESS



Here is an apparatus every amateur should own, a wave-meter. Following Mr Burgess' instructions one may easily be built. On the left is a view of the complete apparatus, while the photograph on the right shows the inside.

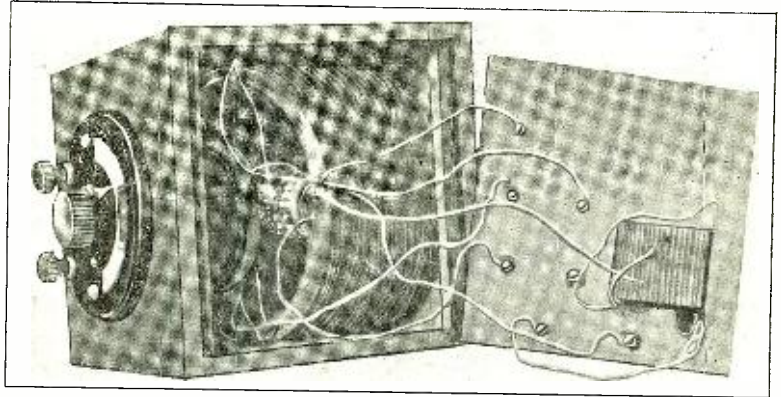

THE great majority of the amateurs do not seem to know what a wave-meter is, altho it is a very useful piece of apparatus every radio experimenter should own.

A wave-meter is useful at first to tune the transmitting sets. When a certain station is to be received the receiving set may be tuned in advance on the wave-length of this station with the wave-meter, making certain the reception of the signals without losing time in tuning.

This apparatus may also be used for the calibration of condensers by the method of comparison. This will be found useful when fixt condensers are to be built by the amateur himself for a new receiving set or for experimental purposes. It consists chiefly of substituting the new condenser for the standard one used in the wave-meter after a measure is done. A certain wave-length being tuned, with a variable condenser in order to have the same capacity in the newly built one, the measure must remain the same when the latter is connected in circuit instead of the standard one.

As can be seen from the photographs, the entire wave-meter is contained in a neat case, thus eliminating external inductance

coils. The interior of this case should be seven inches square and the wood preferably birch with a mahogany finish. For best results a Mesco variable condenser No. 294 with a maximum capacity of .001 mfd. should be used, but if one isn't at hand a Murdock No. 366 with a max. cap. of .001 mfd. will serve the purpose very well. Referring to the photographs it will be seen that this condenser is mounted on the front of the case.

The inductance coil (see photo 2) is mounted inside the case, directly behind the condenser, as shown in Fig. 2. This inductance consists of 46 turns of No. 16 B. and S. gage S. S. C. wire wound closely in a cylindrical drum $6\frac{1}{2}$ inches in diameter. This is straight winding, not banked winding. When wound it should be given

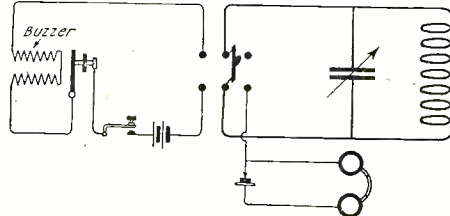

Diagram of the Wave-Meter Which May Be Used to Tune Both Transmitter and Receiver.

a coat of shellac and fastened in place in the case. The following are the condenser readings, from which a curve can easily be plotted:

Condenser Degrees	Wave-Length
0	185
10	225
20	325
30	380
40	465
50	530
60	580
70	630
80	670
90	710
100	760
110	825
120	840
130	890
140	915
150	930
160	980
170	1000
180	1040

The high-note buzzer for exciting the inductance should be mounted on the top of the case, as in photo 1. The writer has found the Mesco No. 55 Radio Buzzer to give very satisfactory results. A flashlight battery, which can be placed inside the in-

(Continued on page 492)

A New Detector-Amplifier Unit *

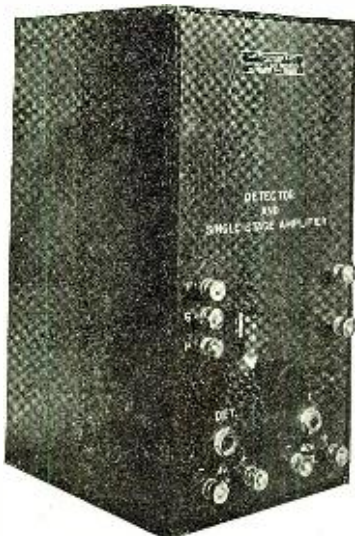

A New Cabinet Unit Embodying a New and Interesting Feature; a Filament Temperature Indicator.

A new Detector-Amplifier unit of unique and effective design is shown in the accompanying photographs.

All elements of the vacuum-valve detectors used in these units are connected to individual binding posts on the face of the panel, making it possible for the operator to use any system or circuit best suited to his particular purpose.

Another distinctively new feature of these units is the filament temperature indicating device, which fulfills a triple purpose, combining a switch for the filament circuit, a resistance control for the same, and an indicator for the filament temperature. The rise of the filament temperature is shown by a rising red column, visible thru a slot in the panel, similar in appearance to an ordinary thermometer.

All circuits are so arranged as to void capacity coupling, and small diameter wire is used for the same purpose. This prevents "howling", even when these units are used in multiple stages of amplification, and makes a unit of this type a very stable and dependable instrument, as well as a helpful asset to long distance receiving equipment.

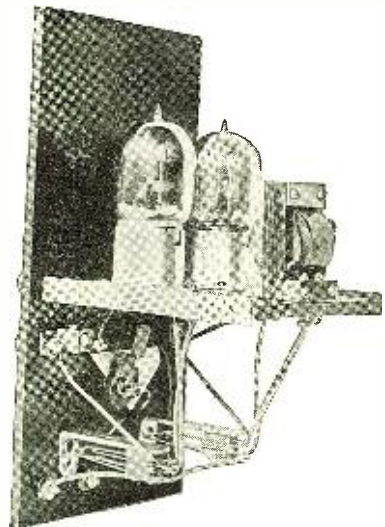

Inside View of the New Detector and Single Step Amplifier Combination. Note the New Filament Control System.

*Photographs by Courtesy of L. M. Cockaday & Co.

How We Came to Have a V. T. Transmitter on the U. S. A. T. Princess Matoika

By F. M. DAGGETT*

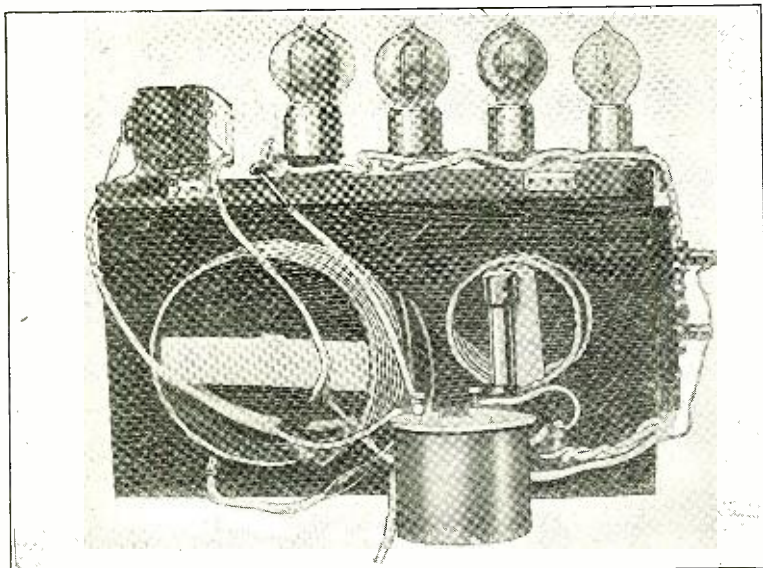

Photograph of the C.W. transmitter built aboard the U. S. A. T. Princess Matoika, and which was used for long distance transmission.

WE are often subjected to heavy traffic at times, particularly when we are carrying a large number of troops. By way of being able to handle this traffic our Radio equipment consists of the following sets: Navy direction finder, short range radio-fone set, three regenerative receivers, CN 240 loaded with wave range of from 1000 meters to 18,000 meters, CN 113 A with a range of 300 to 2500 meters and a Sperry Gyroscopic receiver with a range of 50 to 1000 meters and two 2-step amplifiers. A spark transmitter of 2KW Lowenstein Navy standard type with the waves of 300, 600 and 952 meters. We change the 952, when necessary, to 1600 to work Bar Harbor on heavy traffic which at times takes hours to clear. It was formerly necessary for us to raise NBD on 600 meters and then have him QSY to 1600 meters. Our greatest difficulty was in trying to clear traffic on 600 meters, due to the heavy interference encountered on that wave.

On our trips across the Atlantic we heard undamp't wave stations, which had no compensating waves, working between 1800 and 2400 meters. This made them easy to read. These stations YA, YM, YF, YE, YD, and HG were pickt up in mid-ocean. On making inquiries about these stations, I learned that they were French and German vacuum tube stations of exceptionally low power. Having copied these stations a thousand miles or more in daylight on a two-step amplifier, I became very much interested in them. On arrival in New York, I purchased all available radio books I could find, which contained information on tube transmitters, but after many trials the circuits in the books did not prove satisfactory.

Shortly after this our port of call was changed to Antwerp and Danzig. Later, while in Antwerp, I ran across the tube circuit shown in Fig. 1 and which looked promising as an effective transmitter hook-up. My two assistants and I got busy and built this set, using number 18 solid conductor in the oscillator coils and in the antenna loading inductance. We used six CW 931 VT2 5 watt tubes as transmitters and one as an oscillator. Not having a low reading radio frequency ammeter, we used three half-ampere automobile low resistance lamps in parallel to indicate resonance.

We used these lamps because when in parallel, they had a resistance of approximately 3 ohms which was the best we could do under the circumstances. The condensers used were obtained from our radiofone equipment, and we then utilized the two radiofone generators for the transmitting power which gave us 350 volts each. We were able to radiate four-tenths of an ampere and light only one lamp, making it necessary to discard the other two. We called a few ships on 600 meters and asked them to listen for us on an undamp't receiver on about 2000 meters and found that we were able to hold communication up to 150 miles with ships that had no amplifiers and 350 miles with those that had two steps of amplification. Encouraged by this test we set to work in New York and obtained what apparatus we needed to build a second set, making good use of what knowledge we pickt up by experience on set number 1.

THE SECOND ATTEMPT

In the second set we used Litzendraht wire instead of solid conductor and the set was made up as follows:

The oscillating coils L1 and L2 were wound on a cardboard form 5" in diameter and had 120 turns each of 3/16/38 Litz wire. A high voltage Western Electric condenser C1 type 21 AA 1 MFD. was con-

nected between the two coils L1 and L2 and which will stand 1000 volts: The grid condenser was a small fixt condenser, having approximately .0005 Mfd. in capacity, and across which we shunted a grid leak of 7500 ohms. Our antenna loading coil L3 was wound on a cardboard form 4" in diameter with 150 turns of 3/16/38 Litz wire. The filaments of all tubes were connected in parallel and lighted by a 10-volt storage battery. At first we had rheostats in the positive leg of each tube filament and adjusted the tubes to their best working conditions as these tubes have different characteristics. However, we found that the increase gained with these rheostats was so small that it was hardly noticeable and we did away with them entirely. Instead we connected all the filaments in parallel across ten volts without any means of varying each individual tube, making the set much simpler and equally efficient.

Around the transmitting key was shunted a Western Electric 1MF high voltage condenser C3 to eliminate arcing across the key. This is absolutely necessary or the arc will "hang" across.

A reactance R of about 10,000 ohms was placed in series between the key and the positive leg of the generators to eliminate "pickbacks" which otherwise might ruin the generators.

We next decided to increase the plate voltage from 350 to 700 volts. This was accomplished by connecting the generators of our radiofone dynamotors in series and the motors in parallel. With this set we were able to increase our radiation up to 1.75 Amps and we worked NBD 750 miles in daylight and the S.S. Kaiserin Auguste Victoria (GCTM) 800 miles. We used this set for two trips then decided to make some changes.

IMPROVEMENTS

In sets number 1 and 2 we could not change our wave-length or the coupling, so in order to get a number of variable wave-lengths it was necessary to rewind our antenna loading inductance L3 and make taps. The following taps were made: 1st at the 20th turn, then 2nd tap at the 25th turn, the 3rd tap at the 30th turn, the 4th tap at the 35th turn and the 5th tap at the 40th turn. These taps were soldered to a five-point switch which was connected to the plates of the transmitting tubes and which gave us the proper coupling for best radiation. We then jumped to the ninetieth turn and taps for

(Continued on page 484)

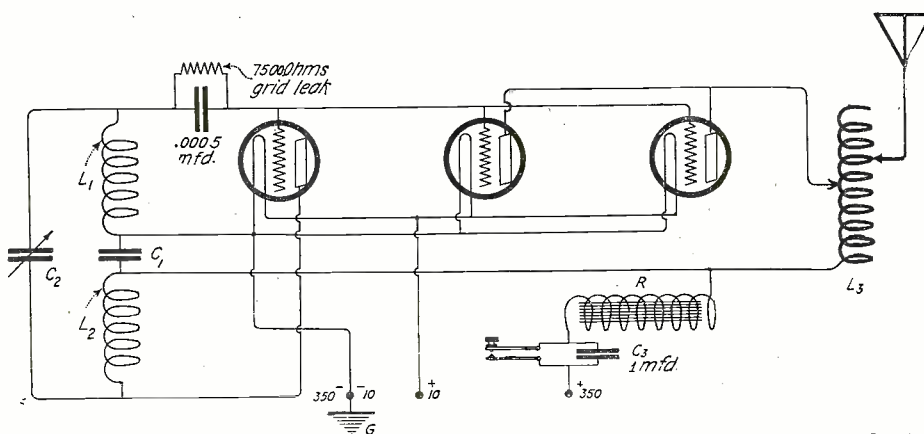
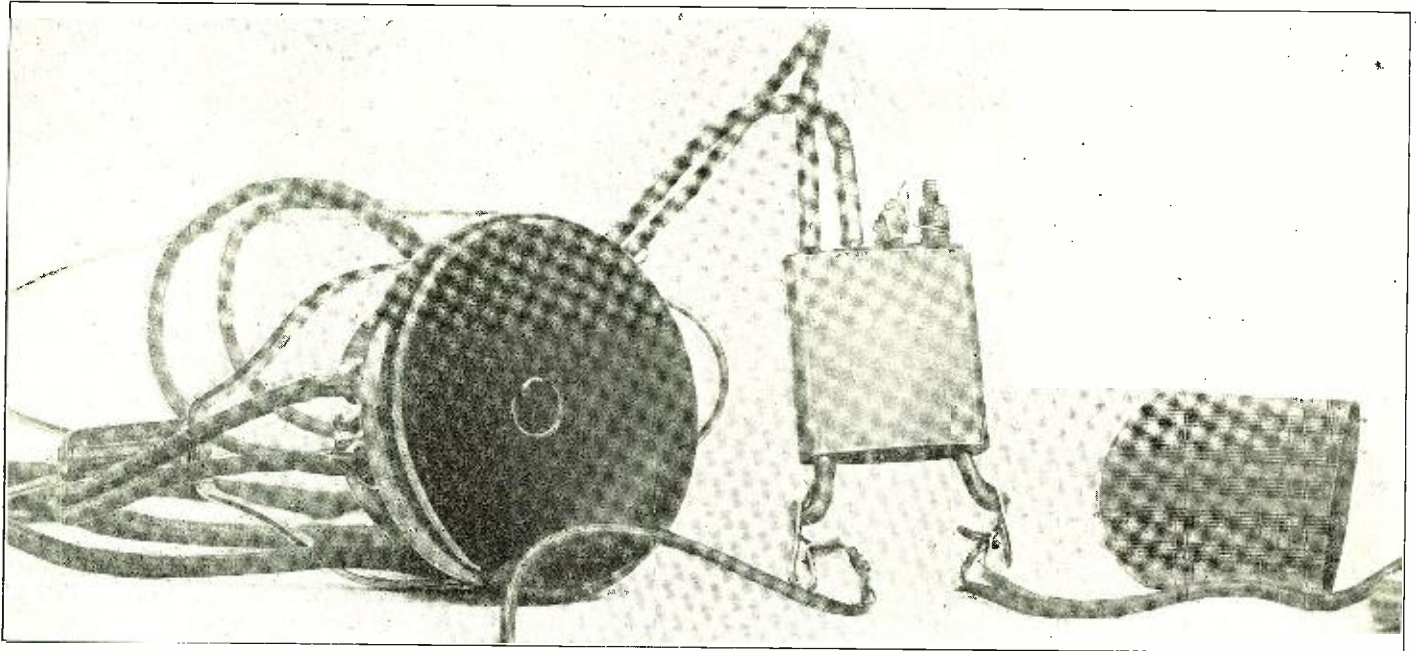

Diagram of Chief Operator Daggett's Transmitter. One V.T. is Used as an Oscillator, While the Two Others are Used to Amplify the Oscillations of the Master Oscillator. This Hook-up is one of the Best Actually Known for C.W. Transmission.

*Chief Operator U. S. A. T. Princess Matoika.

Awards of \$100 Portable Radio Prize Contest

SECOND PRIZE WINNER



Full Size View of Mr. J. L. McLaughlin's Complete Portable Receiver, Showing the Size of the Receiver Itself, in Comparison to the Telephone. Note the Small Detector and the Plugs by Means of Which Tuning is Made. The Case in the Right Hand Corner is Half of the Shell in Which the Set is Enclosed When Carried in the Pocket.

Editor's Note:

Mr. J. L. McLaughlin's portable set, which has been awarded the second prize in our contest, is certainly one of the smallest ever built, for it can be carried in the vest pocket and is so light in weight that one scarcely notices it. Mr. McLaughlin himself says that sometimes he has to search all his pockets to find the set!

This small receiving set has been tested in the laboratory of RADIO NEWS and it works effectively. Radiophone music was heard, as well as signals from ships and amateur stations.

One thing to which Mr. McLaughlin has given careful attention, is the detector; he has selected a very good little crystal of galena which is sensitive all over, and it is the secret of the marvelous results which are obtained with this Lilliputian receiver.

A full size photograph of the instrument appears on this page showing every detail of it; if other amateurs intend to build such a set they can easily do so, all data being

given below by Mr. McLaughlin himself, to whom we extend our compliments for his very ingenious work.

A WATCH CHARM RECEIVER By J. L. McLaughlin

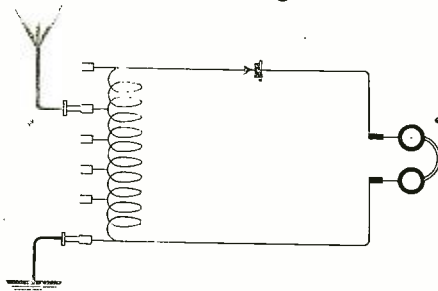

Diagram of Connections of the Little Portable Set.

The portable set I designed and built is $1\frac{1}{4}$ " long and $1\frac{1}{4}$ " wide and $\frac{1}{4}$ " thick without the case, and with it on, measures three inches in length. The case originally was a cigar lighter and when closed up is so small and light it can be carried in the watch pocket. The tuning coil was wound on a form about the size of the inner case, and made of two fiber washers fixed on a bolt. Two hundred and fifty turns of No. 28 S. C. C. wire were wound around this, with a tap every fifty turns; the form was then taken off, the coil dipped in hot beeswax and when dry was pushed into the inner case, with a piece of mica slipped in on each side.

Two pieces of bakelite one-eighth of an inch thick were cut for the ends. In the one used for the detector and fones, four holes were drilled and six holes were required in the piece supporting the plugs for the tuning device. A piece of No. 26 wire was wrapped around the side of each hole, except around the two in which the detector was to be fixed, and to the ends of these taps were soldered the leads from the coil.

The aerial and ground posts were made of

a piece of brass rod; one end of each was split to insure better contact and miniature Fahnestock clips were soldered to the other end.

For receiving, the aerial is connected to one clip and the ground to the other, the fones plugged in, and the detector adjusted; to tune the set one plug is pushed into the first hole, and the other moved along until the proper adjustment is found.

The set is not a freak as it really works very well and tunes up to 600 meters with an ordinary amateur antenna. Several stations have been copied with this receiver using only a bed spring as an antenna and radiophone from seven stations has been heard, including 2XB, 2XJ, WUBA, KQG, 2AWL, and others. The world's series scores were copied from NAH while in a field using only a 1-wire low aerial.

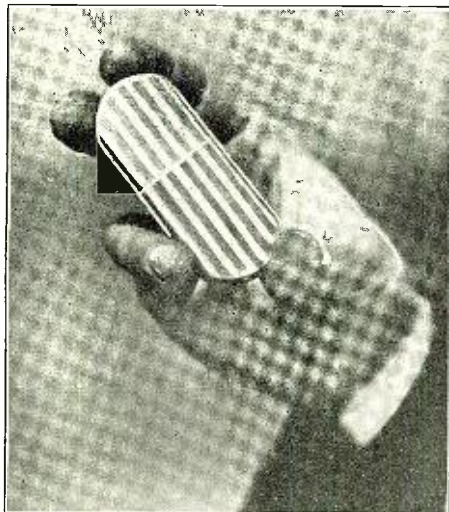

Smaller Than a Watch is This Complete Receiving Set. It Was Built in a Cigar Lighter Case and Can Tune Up to 600 Meters.



Photograph of Mr. J. L. McLaughlin Listening in With His Baby Set, Using Bed Springs as an Aerial.

Comparison of Modulation Methods in Radio Telephony

By A. S. BLATTERMAN*†

Part 2

MODULATION ON AMPLIFIER

WE now consider another method of getting increased modulated output. We may, instead of modulating the master oscillator as above described, use the master oscillator only as a source of excitation for the amplifier which can then be considered as a separately excited oscillator and apply our modulation to it by any one of the methods previously used for the master oscillator. Two of these methods, namely grid modulation,* merit particular study. These will now be compared against each other and also with the previous arrangement just discussed

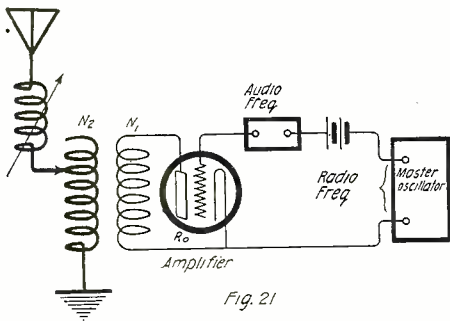

Fig. 21

Diagram of One of the Circuits Used for the Experiments Described in This Article, in Which Both Audio and Radio Frequency Voltage Are Impressed Upon the Grid of the Amplifier.

wherein the modulation was first effected at the master oscillator.

POWER MODULATION OF AMPLIFIER (SEPARATELY EXCITED OSCILLATOR)

The circuit arrangement for this scheme is shown on Fig. 18. The type of modulation obtained is shown on Plate F. Comparison of these records with Plate C which was taken on a self-excited oscillator of the usual capacity coupled type shows that the modulation in the two cases is entirely similar.

Assuming in this scheme a sufficient supply of electrons from the filament, the output of the oscillator can be caused to vary with complete modulation. When the supply of electrons is insufficient the modulation may be complete downward but only partial upward (see Plate E).

The particular question of interest is, given two tubes used in parallel (one oscillator, one modulator) compare in effectiveness with the method using modulated input to the amplifier but with both the tubes used for amplification.

If Y_1 (Fig. 20) represents the maximum current output from one of the tubes as oscillator and Y_2 the maximum from two of them in parallel, then $Y_2 = \sqrt{2}Y_1$. Now the maximum modulated effect at fundamental frequency for the second case, that is both tubes amplifying the modulated output of a master oscillator, is obtained, as has been shown

above, when $\theta_1 = 0$. This condition is shown at (b) Fig. 20. The value of the product AB for this case is, with the help of Fig. 14,

$$0.34 \times 2 Y_1^2 = 0.68 Y_1^2 \dots \dots \dots (17)$$

Fig. 20a shows the case of one amplifier and one modulator. If sufficient electrons are available to give 100% modulation the value of the product AB in this case is

$$Y_1^2 \dots \dots \dots (18)$$

If on the other hand, the modulation is incomplete the value of AB will be less than this; and from Fig. 14 it can easily be deduced that 126° ($\theta_1 = 27^\circ$) must be cut off the peak of the cycle for the value to fall to $0.68 Y_1^2$, which is the maximum obtainable when both tubes are used for amplifiers. If more of the cycle is suppressed than 126° ($\theta_1 < 27^\circ$) then the power modulation arrangement becomes inferior.

Altho the maximum effect at fundamental frequency on the straight two tube amplifier arrangement is obtained when the conditions are as shown in Fig. 20 it will not generally be advisable to use such adjustment because of the distortion. In the extreme case shown, where half the wave is suppressed, the amplitudes of the fundamental and various harmonics are in the ratios

Fundamental	0.785
2nd Harmonic335
4th Harmonic067
6th Harmonic029

so that the second harmonic has nearly half the amplitude of the fundamental. The odd harmonics are absent.

If the undistorted modulation shown dotted in the figure is produced, the measure of effectiveness AB, instead of $0.68Y_1^2$ is

$$2 \times 0.25 Y_1^2 = 0.5 Y_1^2 \dots \dots \dots (19)$$

We conclude, therefore, that the arrangement using one of the tubes as amplifier and one as modulator is generally superior to that using both as amplifiers, provided only that the filament emission is sufficient to permit upward modulation in the first case of at least 45%, which corresponds to $\theta_1 = 27^\circ$.

GRID MODULATION OF AMPLIFIER (SEPARATELY EXCITED OSCILLATOR)

In all systems of modulation the fundamental desideratum is that the modulated

output shall follow in linear proportion the variations of impressed modulating voltage. It is not readily apparent that this result may be obtained when the modulating voltage is impressed on the grid of a vacuum tube having a curved characteristic. It is desirable, therefore, to have this fact demonstrated.

If, for simplicity, we assume the audio frequency modulating voltage to be

$$E_a \sin pt \dots \dots \dots (20)$$

then our radiation must have the form shown in Fig. 1 and be represented by the type of equation (1)

$$i = (A) \sin + (B \sin pt) \sin \omega t \dots \dots (1)$$

and furthermore, the B of this expression

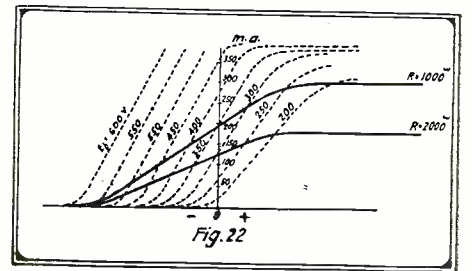

Fig. 22

Curve Showing How a Given Increment of Current Thru the Load Resistance R Produces an IR Drop in the Dynamic Curve Which is Represented by the Solid Lines.

must be directly proportional to the amplitude E_a of the modulating voltage.

The circuit to be considered is shown in Fig. 21. A radio frequency voltage $E_r \sin \omega t$ and an audio frequency voltage $E_a \sin pt$ are both impressed upon the grid of the amplifier. That is, the grid voltage is

$$e = E_r \sin \omega t + E_a \sin pt \dots \dots \dots (21)$$

The amplifier characteristic is given by the power series

$$i = a_1 e + a_2 e^2 + a_3 e^3 + \dots \dots \dots (22)$$

of which higher powers than the second may be neglected. The coefficients a_1 and a_2 may be evaluated as ‡

$$a_1 = \frac{\mu}{R_0 + R} \dots \dots \dots (23)$$

$$a_2 = \frac{1}{2} \frac{\mu^2 R_0^2}{(R_0 + R)^3} \dots \dots \dots (24)$$

where μ = amplification constant of tube

R_0 = internal resistance of tube to A. C. at the mean operating point =

$$\frac{I}{\delta i_\rho}$$

$$\frac{\delta i_\rho}{\delta v_\rho}$$

R_0 = curvature of plate current—plate voltage characteristic at the operating point =

$$\frac{\delta R_0}{\delta e_\rho}$$

R = load resistance in plate circuit.

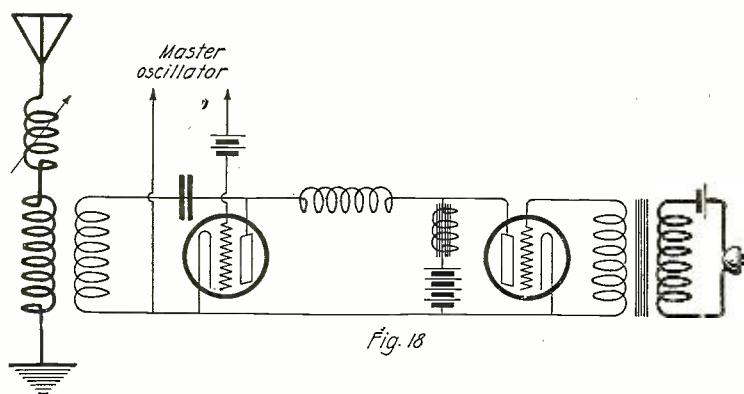

Fig. 18

Typical Radiofone Circuit in Which a Separate Master Oscillator is Used in Conjunction With a Modulator and an Amplifier Tube.

*Application of the constant current method of modulation to a separately excited oscillator was first suggested to the writer by Mr. W. A. MacDonald.

†Radio Engineer, Camp Alfred Vail, N. J.

‡Carson, Proc., I. R. E., Vol. 7, No. 2.

We must substitute for e in the above expression for output current the value

$$E_r \sin \omega t + E_a \sin pt$$

This gives, after dropping all terms whose order of frequency is different from the radio frequency to be passed to the antenna:

$$i = (a_1 E_r) \sin \omega t + (2a_2 E_r E_a \sin pt) \sin \omega t \dots (25)$$

which is of the required form (I)

$$i = (A) \sin \omega t + (B \sin pt) \sin \omega t \dots (I)$$

$$A = a_1 E_r = \frac{\mu}{R_o + R} E_r$$

$$B = 2a_2 E_r E_a = - \frac{\mu^2 R_o^1 R_o}{(R_o + R)^3} E_r E_a$$

It is seen at once that for any value E_r of the impressed radio frequency, the modulated component of output is directly proportional to the amplitude E_a of impressed modulating voltage. There is, therefore, no distortion resulting from operation on the curved characteristic. On the other hand, very brief consideration of the equations (22) and (25) will show that it is this very curvature which makes the modulation possible. The first linear term of (22) simply gives repeating action; but the second, i. e., the squared term indicating curvature, gives the modulation.

With this type of modulation a somewhat different set of conditions must be satisfied for production of the maximum modulated antenna effect than is the case for those methods previously discussed.

Let the antenna resistance be R_a (Fig. 21) and the ratio of turns of the transformer coupling the output circuit of the amplifier with the antenna be

$$n = \frac{N_1}{N_2} \dots (26)$$

Then the load resistance R introduced into the plate circuit is

$$n^2 R_a = R \dots (27)$$

In any particular case, therefore, the load on the tube is adjusted by variation of the transformer ratio n , and the antenna output will be maximum for a certain value



Oscillogram of Modulated Current When the Supply of Electrons is Insufficient.

of this ratio.

In the present case, the output current from the tube is given by (25)

$$i = \left(\frac{\mu}{R_o + R} \right) E_r \sin \omega t - \frac{\mu^2 R_o^1 R_o}{(R_o + R)^3} E_r E_a \sin pt \sin \omega t \dots (25)$$

and consists of a radio frequency component of constant amplitude plus another component of equal radio frequency but having variable amplitude according to the modulation. It will be seen that both components depend upon the load resistance $R (= n^2 R_a)$ but in different ways.

If we wish to make the constant amplitude carrier term maximum in the antenna without regard to the amplitude of the modulated component the conditions can be established as follows:

Let I_1 = plate current (A. C. output component)
 I_a = antenna current

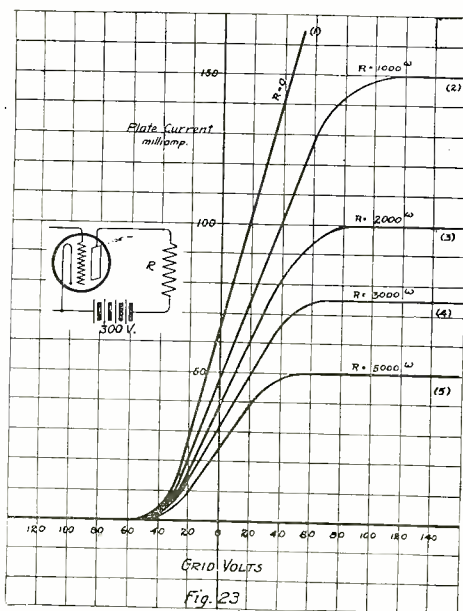

Characteristic Curves of a V.T.-2 Tube for Different Values of Resistance in the Plate Circuit.

- E_1 = voltage across transformer primary $I_1 R$
- E_a = secondary voltage induced in transformer
- R_a = antenna resistance
- n = transformer ratio = N_1/N_2

What is desired is to find the value of n which makes the antenna current I_a maximum.

$$I_a = \frac{E_a}{R_a} = \frac{1}{n} \frac{E_1}{R_a} = \frac{1}{n} \frac{I_1 R}{R_a}$$

$$I_1 = \frac{1}{\sqrt{2}} \frac{\mu}{R_o + R} E_r \quad \text{from (25)}$$

$$R = n^2 R_a$$

Hence

$$I_a = \frac{1}{n} \frac{1}{\sqrt{2}} \frac{\mu E_r n^2 R_a}{R_a (R_o + n^2 R_a)}$$

$$= \left(\frac{\mu E_r}{\sqrt{2}} \right) \frac{n}{R_o + n^2 R_a}$$

which has a maximum when

$$n^2 = \frac{R_o}{R_a} \quad \text{or} \quad n^2 R_a = R = R_o \dots (26)$$

That is, as regards the unmodulated radio component alone its current is maximum when the transformer ratio is adjusted so that the tube resistance and the load resistance are equal.

On the other hand, it can be shown in an exactly similar way, that the modulated component, i. e., the second term of (25), appears as maximum in the antenna when the transformer ratio "n" is adjusted so that the introduced resistance is equal to 1/5 R_o . That is

$$R = n^2 R_a = \frac{R_o}{5} \dots (27)$$

Now, what is actually desired is not that either the first or second terms of (25) shall individually be a maximum but that their product, that is, AB shall be maximum.

We have, therefore, to consider the quantity

$$\left(\frac{n}{R_o + R} \right) \cdot \left[\frac{n}{(R_o + R)^3} \right] = \frac{n^2}{(R_o + R)^4}$$

We find that this is maximum when

$$n^2 R_a = R = \frac{R_o}{3} \dots (28)$$

The transformer ratio must be so adjusted that the introduced load resistance is $1/3 R_o$.

It is of interest to note, by a simple calculation from equation (25) that the ratio of effectiveness (i. e., product AB) for the two cases where $R = R_o$ and $R = 1/3 R_o$ respectively is as 0.062 to 0.106. That is, the former adjustment is approximately 60% as good as the latter.

The best operating point on the characteristic, when adjustment is made so that the load resistance has its best value ($R = 1/3 R_o$), can be determined by noting that the product AB is then

$$AB = \frac{\mu^2 R_o^2 R_o}{\left(\frac{4}{3} R_o \right)^4} E_r^2 E_a$$

$$= [0.316 \mu^3 E_r^2 E_a] \frac{R_o^1}{R_o^3} \dots (29)$$

The operating point should, therefore, be set so that $\frac{R_o^1}{R_o^3}$ is a maximum. This point

can, of course, be readily determined from the characteristic curves of the tube.

The above condition giving the best load resistance as $1/3 R_o$ for the case of grid modulation is essentially different from that required in the other methods of modulation. In all of these other methods the condition is that $R = R_o$.

This difference in the condition for maximum antenna output requires consideration of the dynamic characteristic curves of operation for the tubes before comparison can be made of the relative merits of the grid modulation and other schemes above discussed.

THE DYNAMIC CHARACTERISTIC

The dynamic characteristic to be here considered is quite different from that which represents the operation of the self-excited oscillating tube. In the latter case the grid and plate voltages both vary proportionally with the output load current but in the present case of the amplifier or separately excited oscillator the grid voltage variations are entirely independent of the output current, which affects the plate voltage alone.

When the antenna is tuned, the load in



Oscillogram Obtained When the Value of the Leak is Increased.

the plate circuit is a pure resistance. The change in plate current called for by a change of impressed grid voltage produces a drop in voltage over this resistance and alters the plate potential. The result is a flattening out of the characteristic curve from the ordinary static form otherwise taken, and the greater the load resistance the more pronounced is the effect. If a family of static curves is at hand (dotted curves, Fig. 22) the dynamic curve (solid line) can be derived as follows:

A given increment of current thru the known load resistance R produces an IR drop in the latter. The plate voltage is reduced by the amount of this drop so that the operating point shifts from a higher static curve to a lower one. A further increment of current shifts the operation to a still lower voltage static curve. In the case shown in Fig. 22 for illustration, it is assumed that the load resistance is 1000 ohms. An increment of 50 milliamperes in plate current causes a drop in voltage of 50 volts. If it be assumed that the generator or B battery voltage is held

fixed, then increasing the load resistance to say 2000 ohms would have the effect of flattening the curve still further, as shown.

It is this change in the dynamic characteristic curve occasioned by variations in load resistance that must be considered in comparing the grid method of modulation with the other methods already mentioned.

It has been shown that for best effect in the grid modulation method R must equal 1/3 Ro, while in all other methods R = Ro for maximum. In other words for the grid modulation the load resistance is only 1/3

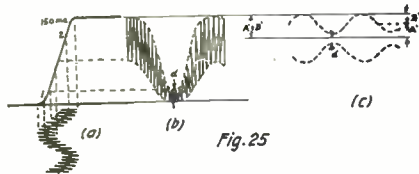

Curve Showing a Case of Amplified Grid Modulation With the Bias Grid Voltage Set at a Certain Value.

what it is for the other systems; and for this reason the operating characteristic is much steeper and reaches saturation much later in the grid modulation arrangement than in any other.

COMPARISON OF GRID MODULATION WITH OTHER METHODS

In order to clarify our conceptions of the comparative operational characteristics of the different modulation schemes let us assume a definite case where a type VT-2 tube is used with a supply voltage of 300 volts. The actual curves involved are then those shown in the Fig. 23, which are drawn for different values of resistance in the plate circuit, of 1000, 2000, 3000 and 5000 ohms. The internal resistance of a VT-2 tube is approximately 3000 ohms under the assumed conditions. For grid modulation, therefore, the load is adjusted to 1000 ohms and we have to consider operation on curve (2). With all of the other methods of modulation, the load must be adjusted to equality with the tube

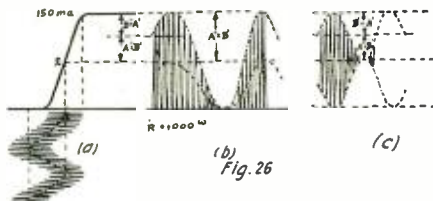

With the Grid Bias Set So That the Radio Grid Oscillations Are Suppress in the Plate Circuit the Peak Value of the Radio Oscillation Just Reaches the Saturation Part of the Curve.

resistance, that is, 3000 ohms, and the operation takes place on curve (4). We shall confine the comparisons to be made to the non-distortion case, that is, so that the operation does not exceed the cut-off and saturation points on the curves.

We see at once that for all those schemes where the amplifier is used to amplify a previously modulated carrier wave, the conditions will be those shown on Fig. 24 (assuming the impressed voltage to be completely modulated).

The product of the A and B components of antenna current in this case will be proportional to

$$A^2 B^2 n_1^2; \text{ or to } 18.75 \times 18.75 \times n_1^2 = 352 n_1^2$$

Where n_1 = transformer ratio n required to make load resistance = tube resistance = 3000 ohms.

In the case of grid modulation we have in reality two cases to consider. The first of these comes rigorously under the above discussion on grid modulation and assumes that the operation is entirely within the

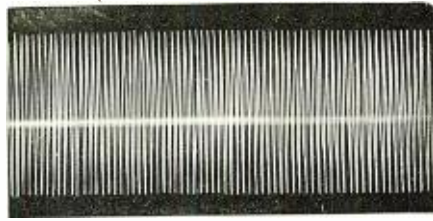

Type of Modulation Obtained With a Separately Excited Oscillator.

limits set by those to which the power series given as equation so the operating curve applies. This case may be represented as in Fig. 25a.

The second case (shown on Fig. 26) is somewhat different altho the deductions made above and applying rigorously to the case just illustrated still hold good for this, with the single exception that there is slight distortion due to the imperfect character of the rectification.

In the first case the sum of the impressed radio and audio frequencies never at any instant takes the operation beyond the cut-off and saturation parts of the curve. The bias grid voltage is set at some value such as P (Fig. 25a) determined by the condition (29). The superimposed modulating grid voltage then swings this median point for the impressed radio oscillations up and down the curve between the extremes 1 and 2 corresponding to very small and very large amplification. The plate current varies as indicated in Fig. 25b, about the average dotted line value, and as regards the transformer passing this to the antenna, is representable as in Fig. 25c.

The second case, that of Fig. 26, is obviously superior to that just described. Here the grid bias is set at such a value that on the negative alternation of modulating voltage the radio grid oscillations are totally suppressed in the plate circuit while on the positive alternation of modulating voltage the peak value of the radio oscillations just reaches the saturation part of the curve. At this instant the radio oscillations may just be repeated with maximum amplification, which is the best condition and is that shown in Fig. 26b, or they may be partially rectified; but in any case, between the peaks of the positive and negative alternations of modulating voltage they will be rectified or cut off at the bottom. The plate current variation is shown on Fig. 26b; and as regards the transformer action is representable by Fig. 26c. The product AB is evidently greater for this type of operation than for that of the first case. In both cases the best adjustment of load is $R = \frac{1}{3} R_o$.

We may now compare the grid modulation with those schemes falling under the type discussed in connection with Fig. 24 where for the VT-2 tube at 300 volts and load resistance $R = R_o = 3000$ ohms it was found the effectiveness could be measured by the quantity $352 n_1^2$. With the grid modulation under the best conditions (case 2) we have

$$\begin{aligned} A &= 37.5 \\ B &= 37.5 \\ R &= 1000 \text{ ohms} \\ I &= \\ n &= \frac{1}{3} n_1 \end{aligned}$$

The figure, therefore, to be used for comparison of this method with the $362 n_1^2$ for the other methods is

$$37.5 \times 37.5 \times n_1^2 / 3 = 468 n_1^2$$

We conclude, therefore, that when increased output is desired thru amplification, the grid method of modulation on the amplifier, when properly used, is superior to first modulating the master oscillator and then amplifying its modulated output.

The only remaining comparison to be made is that between grid modulation and

constant current or power modulation. The problem is similar to some of those already discussed. Given two tubes, is it preferable to use both as amplifiers, modulating on their grids or one as amplifier and one as power modulator?

As representative example, we may take the VT-2 tube above discussed. With two of these in parallel we have both the A and B obtained from one tube increased

in the ratio of 2 to 1, while n is $\frac{1}{\sqrt{2}}$ the value used for one tube. The product of

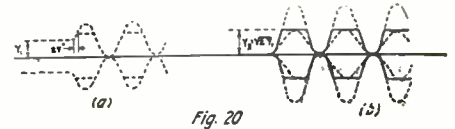

Comparison of Current Output of One Tube as Modulator and One as Oscillator and Two Tubes as Oscillators in Parallel.

antenna components AB is therefore (see Fig. 26) proportional to

$$2 \times 37.5 \times 2 \times 37.5 \times \frac{n_1^2}{6} = 936 n_1^2$$

With one tube as amplifier and one as modulator we have, for complete modulation, a variation in output current of the amplifier from zero to twice normal. For the present case this gives, from Fig. 23 curve (5)

$$\begin{aligned} A &= 37.5 \\ B &= 37.5 \\ R &= 3000 \text{ ohms} \\ n &= n_1 \end{aligned}$$

and the output effectiveness is proportional to

$$37.5 \times 37.5 \times n_1^2 = 1410 n_1^2$$

The power modulation, therefore, gives greater amplitude of detector response than grid modulation in the ratio 1410 to 936; or, differently stated, the grid modulation is roughly 67% as effective as complete modulation by the constant current method

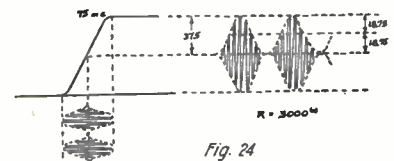

Curve of Modulation Obtained When an Amplifier is Used to Amplify a Previously Modulated Carrier Wave.

and 67% modulation by the latter method is as effective as 100% by the former.

This result has been derived from consideration of a particular example, but the case is, nevertheless, typical and the conclusions may be regarded as generally applicable and representative of the comparative operation that can be obtained by the two methods of modulation.

SUMMARY AND CONCLUSIONS

1. The detector response to a modulated wave is proportional to the product AB of the constant amplitude carrier component by the amplitude of the variable modulating component of currents in the transmitting antenna.

2. Modulation by absorption, detuning or diverting is only one-half as effective as constant current modulation where the latter gives complete modulation and the same total number of tubes is involved.

3. Four times as many oscillator tubes are required for absorption modulation as for power modulation, in order to pro-

(Continued on page 476)

Audio or Radio Frequency Amplifier?

By P. L. WELKE

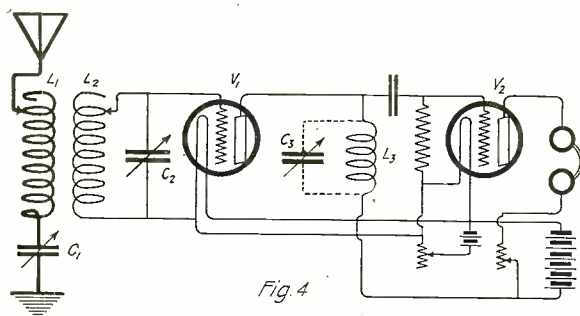

Fig. 4

Fig. 4 Illustrates the Radio Frequency Amplifier Dealt With in This Article While Fig. 5 is the Diagram of the Typical Audio Frequency Amplifier.

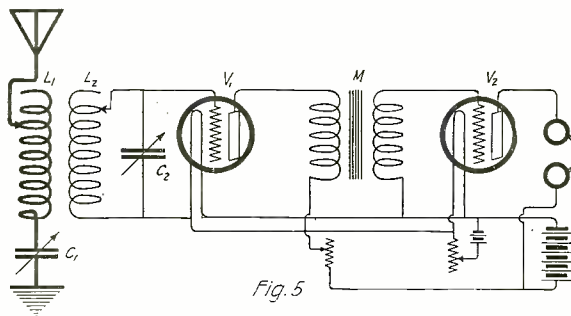

Fig. 5

IN order to accomplish anything more than mediocre results in long distance reception of radio signals it is necessary to utilize some practical method of amplification of the extremely weak currents induced into the antenna circuit of the receiver.

Here the three-electrode vacuum tube, having a non-linear amplification characteristic, offers the most convenient and practical means of securing the desired amplification.

In Fig. 1 this characteristic is illustrated by a curve taken of a Signal Corps V.T.-1 tube. It is seen to be composed principally of a straight portion with a bend at either end. By shifting the vertical line indicating the relation between the grid and the filament to the middle of the straight portion we adjust for amplification, while by operating at a point at either bend we secure rectification. The same results are obtained by selecting different values of plate potential as indicated in Fig. 2.

It is the purpose of this paper to discuss the principles involved in audio and radio amplification as applied to the three-electrode vacuum tube and to point out the greater advantage of amplifying the weak incoming currents of radio frequency rather than those of audio frequency produced by rectification. This is particularly applicable when only a single step of amplification is under consideration.

It is a fact that the three-electrode vacuum tube functions best as a detector when the amplitude of the applied alternating current at the grid is of considerable magnitude. Therefore, in order to detect very weak signals it is essential that these minute currents be amplified at radio frequency before being impressed upon the detector for rectification.

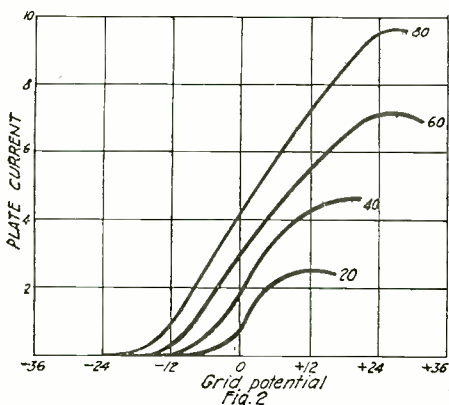

Fig. 2

Some Curves of Plate Current of a V.T.-1 Tube Used in the Experiments Described in This Article.

Referring again to Fig. 1 we may prove the above by a study of the curve. The present point of operation as shown by the heavy vertical line is not suitable for detection but can be used for amplification. However, by inserting a small battery in the grid circuit we may cause the grid to assume a value indicated by the dotted line which will make rectification possible.

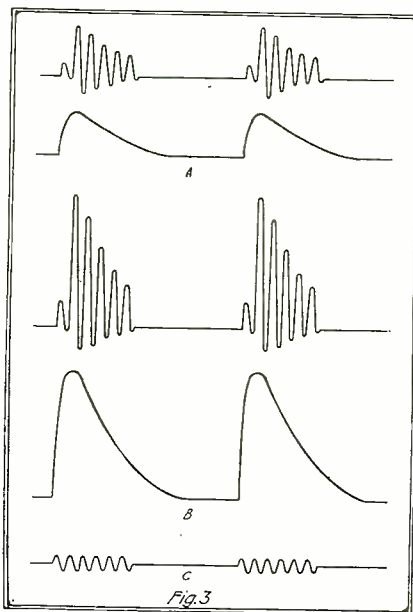

Fig. 3

Curves of the Plate and Telephone Current When Receiving With Detector Only and With One Step of Amplification.

Let us suppose that the amplitude of the current induced into the secondary receiving circuit and therefore impressed it upon the grid to have a value of 2 volts. The observed variation of the current in the plate circuit thus produced is shown in Fig. 3 A; also the corresponding telephone current.

If the amplitude of the signal is increased either by a step of amplification at radio frequency or by receiving from a more powerful transmitter to a value of 4 volts, the increase in the variation of the current in the plate circuit is seen, Fig. 3 B, to be very marked.

On the other hand, when the received signals are very weak the result will not be rectification at all but only a repetition or slight amplification of the signal at a radio frequency, Fig. 3 C. No variation of the current in the plate circuit then takes place and therefore no sound may be heard in the telephones.

Since the degree of audibility in the telephones is dependent upon the magnitude of

the variations of the current flowing through them, the advantage of the amplification is very evident.

Fig. 4 illustrates the connections of the apparatus under discussion. A series grid condenser is employed in the detector circuit to prevent the plate battery potential from being impressed upon the grid of the second tube. This alters somewhat the direction of the variation of current in the plate circuit as previously explained but the same general principles are involved. Choke coil coupling is used and the action which takes place when a radio signal is being intercepted may be briefly reviewed as follows:

The incoming currents of radio frequency set up oscillations in the antenna circuit L_1C_1 which is tuned to their frequency. Another tuned oscillatory circuit L_2C_2 is coupled to the antenna circuit and the resonant condition thereby produced causes the maximum amount of energy to be transferred. This alternating e.m.f. of radio frequency is thus connected across the grid and filament of V_1 which is adjusted for maximum voltage amplification. This is accomplished by a proper selection of plate voltage and an inductance of large value connected in series with the plate battery.

The received oscillations are then repeated in the plate circuit but considerably amplified, the degree of amplification depending upon the amplification factor of the tube. The coil L_3 inserted in the plate circuit has a counter e.m.f. equal and opposite to that induced by the pulsations of the plate current, so that while a flow of current is effectively opposed by the high reactance, the voltage amplification obtained from V_1 will be applied to the detector which will then operate with increased efficiency as previously explained.

If a condenser is shunted across the coil L_3 so that the natural frequency of the circuit L_3C_2 is equal to that of the received oscillations, the reactance of the plate circuit may be made infinite and maximum

(Continued on page 474)

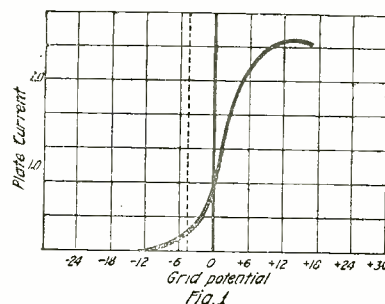
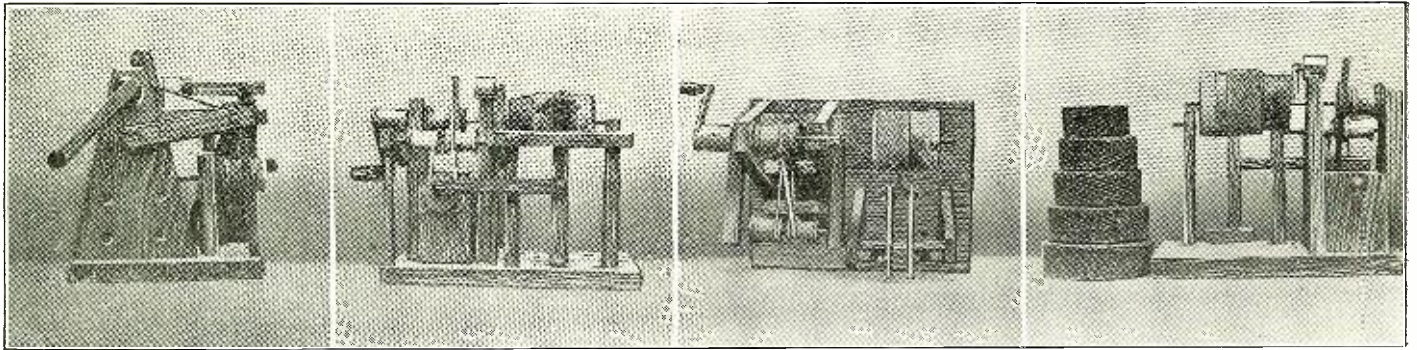

Fig. 1

Curve of a Signal Corps V.T. Class 1 Tube Having a Non-Linear Amplification Characteristic.

A Honeycomb Coil Machine That Works

By RAYMOND ROOF



These Photographs Show Every Detail of the Honeycomb Coil Winding Machine. Which May be Entirely Built by the Amateur Who Has Had a Little Hand Practice.

AFTER some weeks of experimenting I have developed the following machine which I may say has given me very satisfactory results in the winding of multi-layer coils, suitable for amateur work.

The wood should be a hard wood, nearly all pieces being $\frac{1}{2}$ inch thick. The pieces A are 4 inches wide at bottom and taper to 1 inch at the top, $\frac{1}{2}$ inch thick. The other materials are as follows: All dimensions given are in inches:

2 pieces, $2 \times 3 \times \frac{1}{2}$, bearings B
1 piece, 2×2 dia., roller C
1 piece, optional, handle D
2 pieces, $4 \times \frac{3}{4} \times \frac{1}{2}$, bearings E
1 piece, $1 \times \frac{28}{32}$ dia., upper pulley F
1 piece, $1 \times \frac{29.5}{32}$ dia., low pulley G

1 piece, $6\frac{1}{2} \times \frac{1}{2} \times \frac{1}{2}$, arm H
1 piece, $4\frac{1}{2} \times \frac{1}{2} \times \frac{1}{2}$, connecting rod I
2 pieces, 5×3 taper, $\frac{3}{4}$ at top $\times \frac{1}{2}$, brace K
1 piece, $4 \times \frac{1}{2} \times \frac{1}{2}$, support and slide L
1 piece, $3 \times \frac{1}{2} \times \frac{1}{2}$, support and slide Q
1 piece, $5 \times \frac{1}{4} \times \frac{1}{4}$, belt adjuster N
1 piece, brass, $\frac{1}{4}$ taper to $\frac{1}{8}$, needle O
2 pieces, $3\frac{1}{4} \times \frac{3}{8} \times \frac{1}{8}$, needle adjuster P
2 pieces, $\frac{1}{2}$ cube, space blocks R
M is a Veeder counter to count the turns.

The pieces E should be pivoted at their lower ends, so that they may be raised to tighten the belt. The two spools, F and G, or pulleys, should be turned very carefully, the upper spool to $\frac{28}{32}$ and the lower to $\frac{59}{64}$. This difference in diameter determines the spacing of the turns. If desired, the upper one can be tapered a sixteenth of an inch, so that the spacing may be adjusted by means of the belt adjuster N. The pieces P should be cut from some soft wood and glued to the block to which the needle C is screwed. The splts are for the purpose of pulling the needle away from the coil as it becomes larger. The pulleys are covered with one layer of sandpaper to prevent the belt slipping. The ends of the sandpaper should meet and form no ridges. It is suggested that this paper be glued firmly to the spools. The reliability of the machine depends upon the care taken in turning and covering the spools, so this job must not be slighted.

The support assembly K K L Q R R, a top view of which is shown in our diagram, is to steady the arm H. The arm H should just slide in the space, with very little clearance. This may be done by putting pieces of paper between the blocks R and the

wood, until this result is secured.

The needle O should have a small hole in the small end thru which to thread the wire, and should be bent to conform to the curve of the coil. If desired, a piece of wood may be screwed and glued to the side of H, to keep the needle and needle-adjuster perfectly horizontal. If it is not kept horizontal, the width of the coil will vary.

All shafts should be of metal, if satisfactory results are to be desired. The pulleys should be fastened firmly to the shafts, either by a set-screw or with a pin. Too much play in the bearings should also be avoided.

(Continued on page 484)

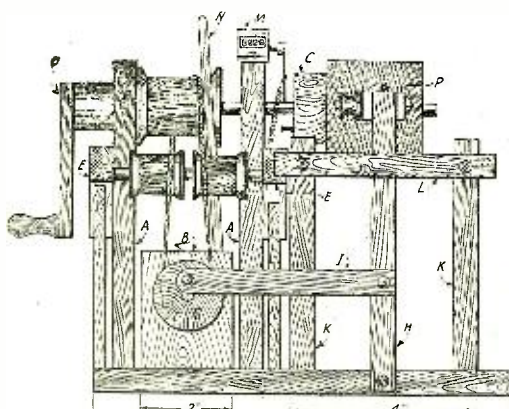

Front View of the Winding Machine. Note the Clever System Allowing the Spacing Between Turns to be Changed.

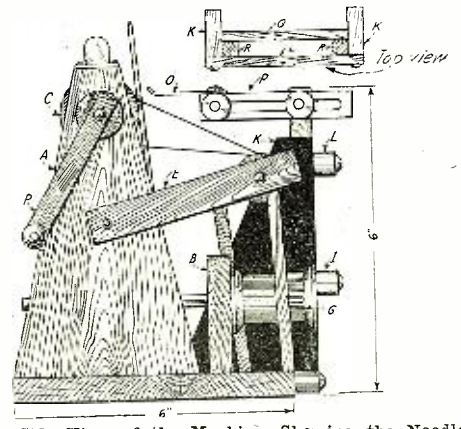

Side View of the Machine, Showing the Needle by Means of Which the Wire is Applied on the Coil, and Which is Moved Away as the Diameter of the Coil Grows.

Amateur Transatlantic Telephony

Editor's Note:

Mr. Hugh Robinson, of Keyport, N. J., whose voice was heard in Scotland on October 6, carried out other experiments during the month of November trying to again reach the other continent.

It seems that he succeeded in his attempt, for he received from the Scotch amateur the letter we publish below:

18 Mile End Avenue,

Aberdeen, 19th November, 1920.

Dear Mr. Robinson:

Mr. G. Benzie, Culter, Aberdeenshire, with whom I am working on wireless reception, has already written you about a wireless telephonic message sent by you, which we pickt up on October 6th, 1920.

I, myself again succeeded in hearing you on Thursday, Nov. 18th. between the hours of 7:10 p. m. and 7:20 p. m. G. M. T. Would you kindly write me a full report of what you did and said between those times

on that day?

I have handed to the Press here a statement of what came thru, and your letter will be shown to them for verification. Please state wave-length and also total power in watts used. We thot you said when we pickt you up last time that power was 400 watts, while in the Press reports from your side it is stated as 100 watts. In any case the results are surprising.

If you wish to arrange for future tests, any day between 7 p. m. and 12 midnight G. M. T. will suit me.

We are delighted with the results which the experts here tell us are "freaks." If we can continue receiving, this will prove that if it is freak work, at least we can carry on.

I wish to congratulate you on your great success in transmission, and hope that some day when restrictions here are removed—I

may call you up and talk to you across the seas.

I am,

Yours sincerely,

(Signed) JAMES M. MILLER.

Later, 20th November, 1920.

P. S.

I also pickt you up yesterday, Friday, 19th Nov., 1920, Time 6:15 to 6:54 p. m. G. M. T. I have appended on separate sheet details of what I heard. Will you please verify if correct?

When you send me a note of when you are to transmit, please be particular about the hours as the times fixt in your letter to Mr. Benzie would have been 4 to 6 o'clock in the morning, rather early to get up for me.

As you probably can pick up FL which gives G. M. T., would it not be advisable for you to set a watch to this time and give me the time in G. M. T., etc., etc.

J. M. M.

A Regenerative Improvement

By G. N. GARRISON

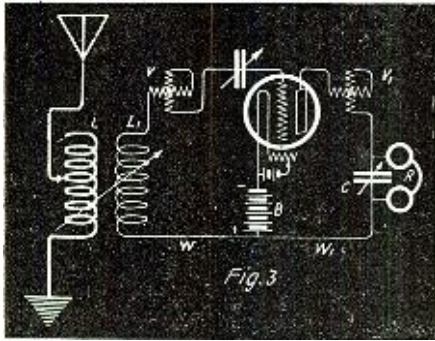

On the left is the hook-up of Fig. 2 with the B battery removed from the oscillating circuit, while on the right is the complete diagram of a short wave regenerative receiver with V.T. detector and 2-stage amplifier. All taps are eliminated from the circuit, the tuning being made with condensers and variometer only.

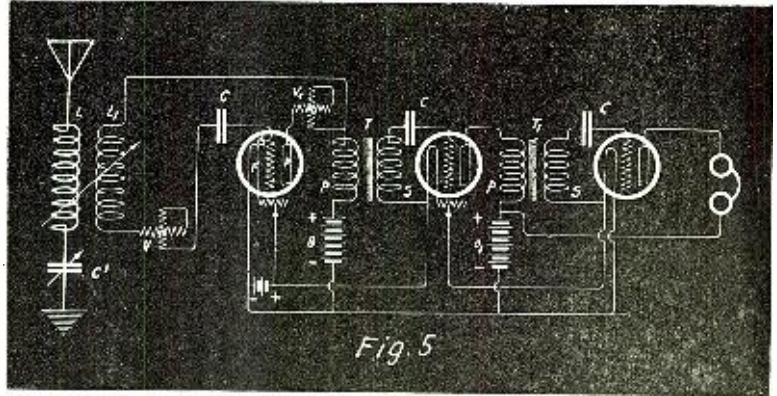

IT has been the writer's good fortune (or bad fortune) during the past ten years of radio experimenting to try many hundreds of wireless hook-ups, both for transmitting and receiving. Some of the numerous hook-ups tried, were indeed very good and accomplish the purpose for which they were intended. Others, while no doubt doing all that was claimed for them, were either too critical of adjustment or incapable of sharp tuning. The great majority of them were simply modifications of hook-ups that had been previously tried. In the following paragraphs I will endeavor to describe a system, the results of which will be at least equal to the addition of another step of amplification, without, however, incurring any additional expense.

In order more fully to understand the principles involved, we will refer to Fig. 1, where is given the standard and much used DeForest "Ultra-Audion" circuit. Many amateurs make use of this circuit under the mistaken impression that, because it is suit-

able for the reception of undamp't waves, it is, of necessity, a good regenerative circuit. Such, however, is not the case. And the reason is simply that the degree of regeneration is not easily controlled. In this hook-up, the circuit GL'WRBF represents the input while the circuit PRBF represents the output. Now the oscillating circuit is depicted by GL'W and P. To control the regeneration of this circuit it is necessary to either vary the secondary coupling or inductance, the plate potential or the filament current, all of which is highly undesirable. While varying the secondary coupling or inductance will succeed in partly controlling the regeneration, it will, at the same time, vary the wave-length of the entire circuit. When filament current and plate potential are once found for maximum signal strength, it is very desirable to leave them at that setting.

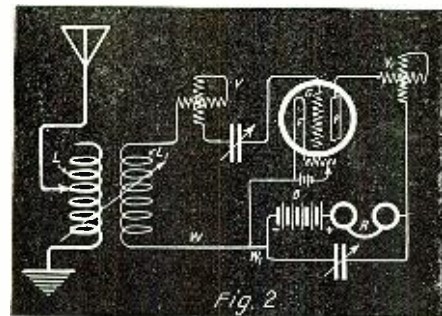

In This Regenerative Hook-up Variometers are Used to Tune the Grid and Plate Circuits.

To overcome this difficulty, some radio concerns have placed upon the market, cabinets in which variometers are used both for tuning the secondary circuit and for controlling the regeneration or amplifying effect. Figures 2 and 3 show the difference

in these two manufacturers' circuits. In Fig. 2 the input is represented by GVL'W F, while the output is designated as PV'RBW'. Variometer V controls the inductance, and consequently the wave-length of the secondary circuit, while variometer V' is used solely for amplifying and does not effect the wave-length of the circuit. The oscillating circuit in this case consists of GVL'WW'BRV' and P. It will be noted that both the fones and "B" batteries are included in the oscillating circuit, thus offering a considerable impedance to the passage of high frequency current. In point of fact, the amount of impedance in a circuit thus formed would probably be so high as to cause it to fail to regenerate or oscillate at all had the manufacturer not placed, or advised the use, of a variable condenser shunted across the fones and "B" batteries for passing these high frequency currents.

Fig. 3, while simply a modification of Fig. 2, is, nevertheless, better practice, since the "B" batteries, B, have been removed from the oscillating circuit and now form part of both input and output circuits. This circuit still leaves much to be desired since the fones and their consequent high impedance are still in the oscillating circuit. It was therefore necessary in this case to shunt the fones by the condenser C for passing the high frequency current. Variometer V, in this hook-up, as in circuit 2, is used solely for tuning the secondary or grid circuit while Variometer V' tunes the oscillating or plate circuit.

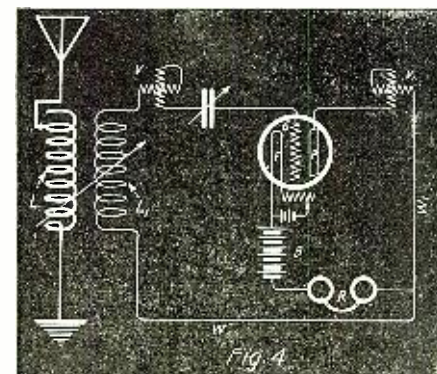

Here is the Best Diagram of a Short Wave Receiver with V.T. Detector. The "B" Battery and Telephones Are Out of the Plate Grid Circuit.

Our oscillating circuit now has a "free sweep" from GVL'WW' thru V' to P, unimpeded by condensers, "B" batteries or fones. This arrangement has resulted in the reception of signals, with the use of a two-stage audio-frequency amplifier that have been equal to, if not greater in intensity, than it was possible to obtain on a three-stage amplifier. For it must be remembered that, in Figures 2 and 3, if the value of condenser C is not changed for each change of wave-length of the input circuit, a considerable amount of reactance will be added to the oscillating circuit, thus defeating the purpose for which the condenser was intended to be used. The amount of reactance will be proportional to the difference in phase between the input and output circuits.

Fig. 5 gives a complete hook-up of a detector and two-stage audio-frequency am-

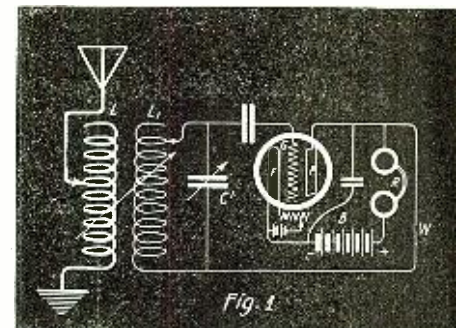

Here is the Well Known Ultra Audion Circuit Which is the Simplest Regenerative Hook-up.

plifier, using circuit 4 as a basis. It is of interest to note, however, that taps are entirely eliminated from both primary and secondary, the tuning of the primary being accomplished by the use of a series condenser, C'. In this circuit, coupling between the tubes is accomplished by the use of two iron-core audio-frequency amplifying transformers T and T'. By using two sets of "B" batteries the capacity between these units is eliminated. The use of condensers C will entirely depend upon the tubes employed in the amplifying circuit. With certain tubes they are an essential; with others they are optional.

In this circuit the writer selected two tubes of identical characteristics (two Westinghouse Type RA tubes), and connected the filaments in series thru one rheostat. This resulted in the saving of at least .8 of an ampere which is of considerable importance where re-charging facilities are not readily available.

By the use of the circuit of Fig. 5, radio-fone music and speech could be distinctly heard a great distance from the fones.

A Complete Portable Set

By D. R. CLEMONS*

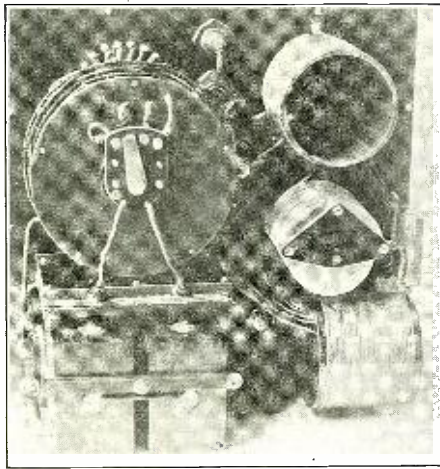

Fig. 2. Inside View of the Complete Portable Set Designed and Built by Mr. D. R. Clemons. Everything is Fixed on the Front Panel in a Very Clever Way.

THERE are many ways in which a portable station may be used. This is particularly true when a portable equipment is constructed for both transmission and reception of telegraphic signals. Those interested in portable radio equipment have specific services to which the instruments must be suited. It is essential that an equipment of this sort should conform to the definition which reads: "not bulky or heavy that may be carried from place to place."

Ordinarily a two way telegraphic radio station involves three groupings: send-receive unit, antenna system, and source of power. Generally in this connection we have two alternatives. We may assemble the necessary equipment in one inclosure which may also contain all accessories such as antenna, head fones, ground systems and battery; or we may divide all the component parts into several containers,—a most common feature.

During war activities, I had almost daily occasion to equip and maintain some eight or ten portable radio stations of more approved design. This variety of equipment was beautifully made; each unit designed to be very light and compact. One of these simple stations was subdivided into five parcels and was built to function under the most satisfactory conditions prevalent. For two-way telegraphy the separately mounted receiver and transmitter made it necessary to shift the antenna leads from one to the other during operation of the

station. Much embarrassment often resulted from this rather awkward arrangement. When one or two of the necessary parts failed to arrive on location, there was much delay. The absence of one of the units would interfere seriously or prevent operation altogether. This is common where many separate mountings are used; for in civil or military usage there are trivial incidents arising that cause the temporary loss of useful parts. It has often occurred to me that a portable station equipment would be more desirable if it were self-contained and built for that specific purpose. The apparatus to be described is not presented as a solution of this problem; but in it we do have a complete send-receive station that is self-contained and is also portable.

Illustrations included show the design and arrangement of the set. The send-receive apparatus is mounted within a strong wooden cabinet. For transportation, this cabinet slips into a heavy canvas carrying case measuring 13" x 13" x 8" over all. The antenna, counterpoise, leads, and telephones are carried in a pouch built into the canvas case. An adjustable web shoulder strap is also provided. These parts are illustrated.

DESCRIPTION

In this portable send-receive set, a com-

plete transmitter and receiver is mounted upon a single Formica panel twelve inches square. For portable use, it must be remembered that simplicity is essential to efficient operation. Movable and interchangeable parts are not well suited to field work. Furthermore, the constants of the antenna system vary where changes of location are frequent. A "stand-by" or pick up circuit then assists in locating a desired station, after which the set may be tuned more critically, gaining increased audibility and selectivity. The receiver to be described consists of a primary tuning inductance, coupling condensers, secondary inductance, variable condenser, fixed stopping condenser and detector mounted as shown in the illustrations.

Figures 2 and 3 show the arrangement of parts upon the panel. The controls to the left are for receiving primary inductance, secondary variable condenser, "stand by" and "tune" switch, secondary inductance switch, detector, and telephone connections. To the right are secondary of transmitter, primary coupling wave-change switch, spark plates, coil vibrators, sending key and power terminals. Antenna connection, send-receive aerial switch, and ammeter are centrally located.

For stations of this variety, there should be provision made for communicating with

On the right is a drawing of the various parts used in the construction of Mr. Clemons' set. These details are given for the benefit of the amateur who may build such a set for field use.

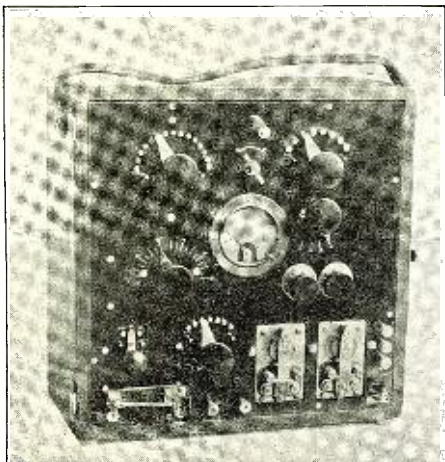
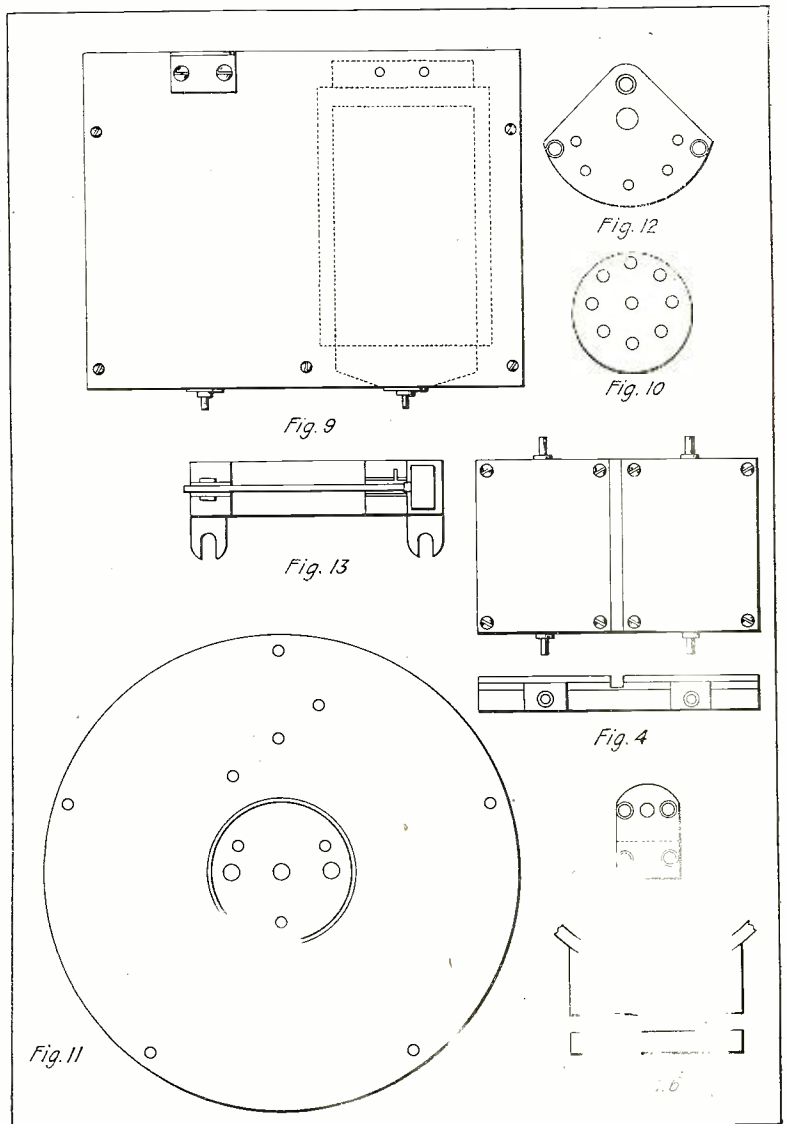
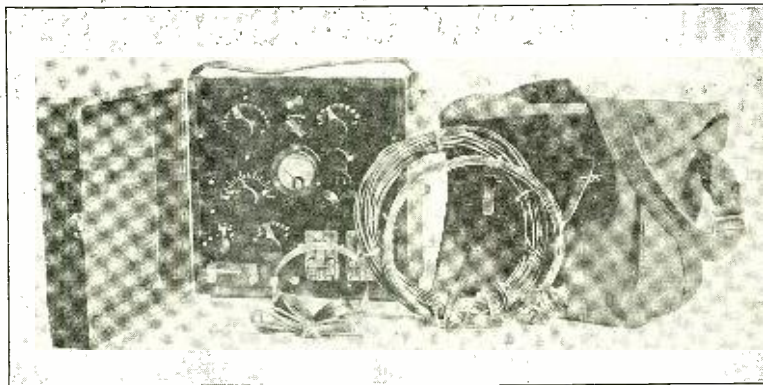

Fig. 3. On the left is a photograph of the portable set. Note the good looking arrangement of instruments on the panel.

*Instructor Radio, Dodge's Radio Institute.

a similar station with an additional range for reception over the wave-lengths used by commercial and other stations. Reception may be made over wave-lengths of 100, to 2,500 meters. In this receiver all parts are stationary. For tuned reception, energy transfer is effected thru two small condensers permanently adjusted for very loose coupling. Static coupling to secondary is thus provided. For short waves it is equal to magnetic with a further increase of efficiency with wave-length. For picking up a desired station, a detecting circuit is placed directly upon the coupling condensers. By this arrangement any currents in the aerial, effect the detector. On varying the primary inductance, any frequency tuned in will be recorded. By placing a small switch in the "tune" position, the secondary is included and subjected to the potentials of the coupling condensers. By further adjustment to resonance, the incoming signal strength is increased due to the greater persistency of the oscillating currents in the secondary system. Furthermore, the capacitive coupling between the two circuits is very critical due to the small values given the coupling condensers. It is adjusted for sharp tuning when in the tune position.

On the right is the complete set with its canvas carrying case, the aerial and ground wire and telephone receiver as it appears ready for use.



An illustration shows the arrangement of instruments on the rear of the panel. Bank windings of two layers are used on both primary and secondary inductances. The primary is of 3,500 mlys. divided and tapt at fifteen points. The secondary is of 3,000 mlys., tapt at seven progressive points to provide over-lapping wave-length bands over its range. A variable condenser of .001 mfd. capacity shunts any effective value of secondary. Two small mica coupling condensers of .00015 mfd. are clamped

securely and mounted beside the variable condenser as shown. This condenser is shown in Fig. 2 and the wiring diagram in Fig. 5; the detector is mounted on the panel front.

For field or portable stations, it is important that transmissions should be made purely upon any wave-lengths used. Plain-aerial transmissions are not sharply defined and are not desirable in congested districts. Moreover, where a portable may also be used in a station, provision should be made for radiating wave-lengths permitted and authorized for that station. In selecting a type of transmitter for this set it is understood that it must be tuned; be capable of quick application and adjustment on different antennae, and yet be simple, efficient and dependable. The spark system is used in the transmitter.

Two spark coils are clamped to the panel back, their vibrator parts exposed thru openings in the panel. Both primary circuits are connected in series and only the vibrator is used; the other being held in reserve by tightening the screw adjustment. A small strapkey projects outward thru a small aperture in the panel in the lower right hand corner. Both secondaries in series charge the transmitting condenser of .001 mfd. mounted directly above the coils. The condenser is of two banks in series; each bank being adjusted to .002 mfd. by employing mica sheets between foil surfaces. The spark gap and inductance are not directly in contact as usually found, but instead, the primary inductance and spark gap are each on separate branches of the condenser circuit.

The spark gap is mounted upon the panel front. This unique gap consists of two phosphor-bronze plates cut as circular discs but mounted eccentrically; i. e., their central rotary axis is 1/8" off center. Each is rotary and fitted with composition knobs. The gap length may be increased from contact to 1/4 inch. The knob, plate, and cylindrical brass bushing are all mounted on a threaded brass rod that passes on thru a stationary bushing, panel, and condenser terminal bracket. A spring provides a friction bearing holding the gap in any position.

Four transmitting wave-lengths of 100, 150, 200, and 300 meters are provided and all are affected on the antenna designed for this set. The primary is tuned by selecting

(Continued on page 468)

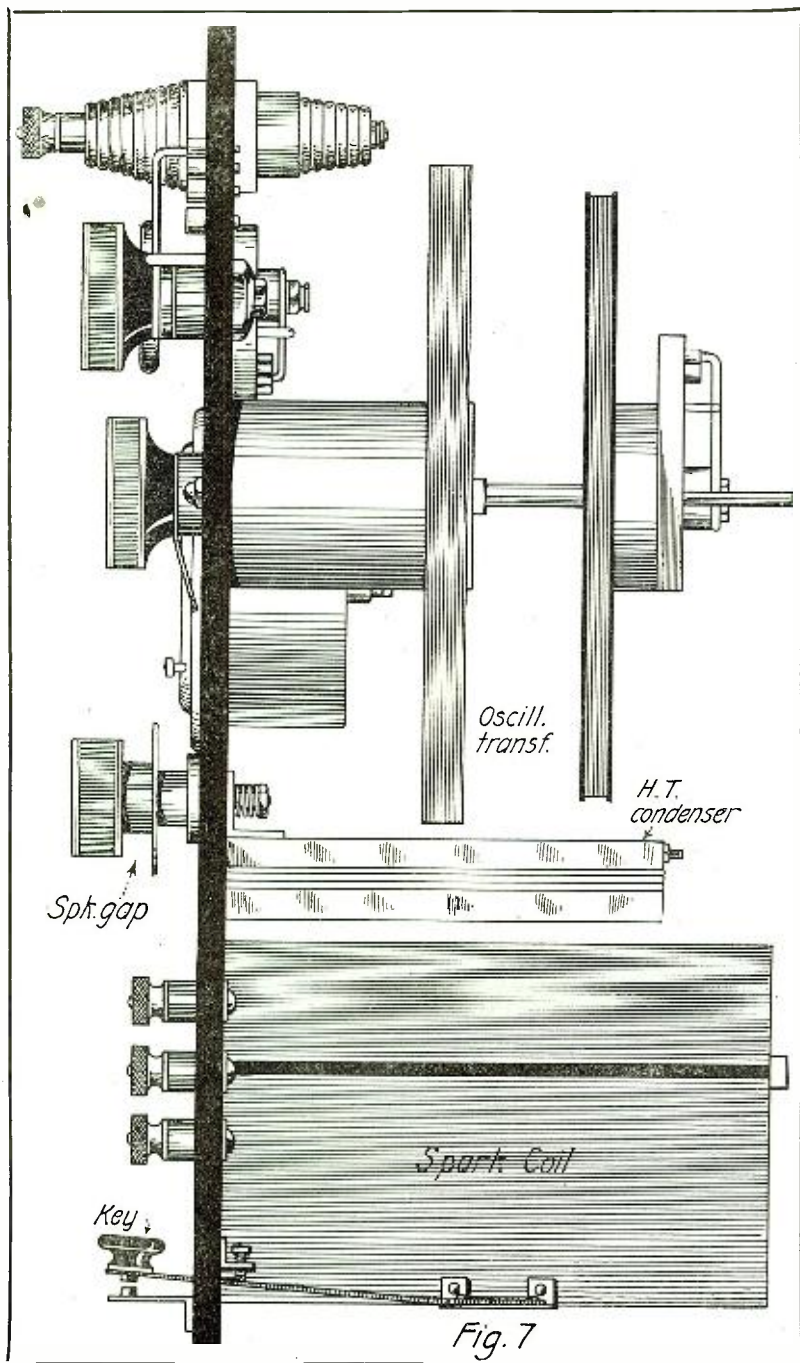

On the left is a side view of the panel showing how the spark gap, the key and the coupling of the oscillation transformer are made, while on the right is the complete hook-up for this set, using two spark coils and a two-section H. T. condenser.

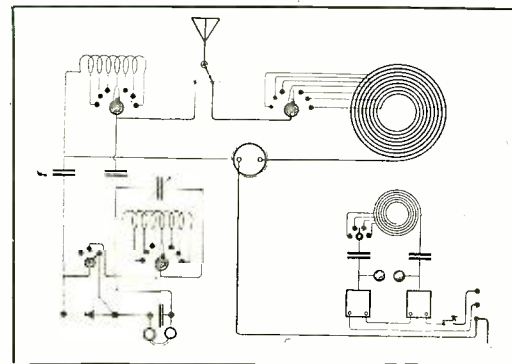

Thermionic Vacuum Tube As Detector, Amplifier and Generator of Electrical Oscillations*

By W. H. ECCLES

ANY kind of matter that can be heated above incandescence without destruction emits electrons; that is, corpuscles of negative electricity. In consequence, if a hot and cold electrode have suitable E.M.F. applied between them negative electricity is propelled across the space and constitutes a thermionic current. If air is present the phenomena are complicated, but in a vacuum they are relatively simple. Our knowledge of the phenomena is largely owing to the work of O. W. Richardson and Irving Langmuir. In extremely high vacua the whole current consists of electrons leaving the hot cathode and entering the substance of the cold anode. If the cold electrode be made negative and the hot one positive, the electrons will not leave the hot conductor and, therefore, there is no current.

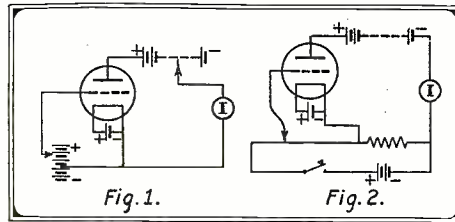

Two Methods of Determining Space Charge in Valves.

rapidly the hotter the conductor. However, not all the electrons can be taken to the anode by a small E.M.F.; in fact, for each voltage there is a temperature beyond which it is useless to go on account of the fact that the space charge when large enough makes the electric field near the cathode zero, and no more electrons can leave the cathode until the applied voltage is increased. It is easy to increase the applied P.D. up to such a value that all the electrons being emitted from the filament are carried across to the anode immediately, and thereafter no increase of P.D. can produce a greater current; this state is called the saturated condition for that temperature of the cathode.

This phenomenon has had applications as a so-called limiting device, which is such a device that however large be the voltage accidentally applied, the current passing thru a chain of apparatus protected by the limiting device cannot exceed a pre-determined value.

The best-known form of diode in this country has a straight filament as cathode and a co-axial metal cylinder as anode. Of necessity the ends of the filament project beyond the cylinder and are cooler than the central parts, and this leads to different portions of the filament reaching the saturation value in turn as the voltage between the cylinder and filament is gradually increased. The curve connecting current and applied P.D. departs therefore from the three halves power law and becomes nearly straight over a considerable range. One convenient result of this is that the tube behaves as if it had a constant internal back E.M.F. and a constant internal resistance over that range. This greatly facilitates calculations.

THE ADDITION OF A THIRD ELECTRODE, OR GRID.

The thing which has brought the thermionic valve into prominence is, above all, the addition of a third electrode; such an instrument may be called for short a triode. In tubes of cylindrical type the third electrode is usually a co-axial helix between the filament and the cylinder.

The third electrode was first introduced into the tube by L. de Forest. Perhaps the aim of early experimenters with a third electrode was to deflect the electrons sideways during their flight, and so effect the current. As a fact, it acts by annulling the electric field of the space charge, especially near the cathode, and its influence on the electrons is of the nature of an acceleration or a retardation in their line of motion; an acceleration if the third electrode is made positive, a retardation if it is made negative. The third electrode, or grid, as it is called, is made of small surface so as not to absorb many electrons—it may take the form of a helix of wire, a piece of metal netting or a perforated

cylinder, or any other form that will allow electrons to pass thru it on their way from the filament to the anode. Because it is nearer the cathode than is the anode, a positive P.D. of, say, one volt, has greater influence on the space charge than an equal P.D. applied to the anode and therefore, as regards annulling the back E.M.F. of the space charge, one volt on the grid is worth several on the anode. In many small tubes it has values like 10 and 20. It can be measured crudely, as indicated in Fig. 1, by inserting one cell in the grid circuit and finding how many must, in consequence, be removed from the anode circuit in order to keep the current constant—but it is more accurately and quickly measured by the slide wire arrangement of Fig. 2, wherein the sliding contact is

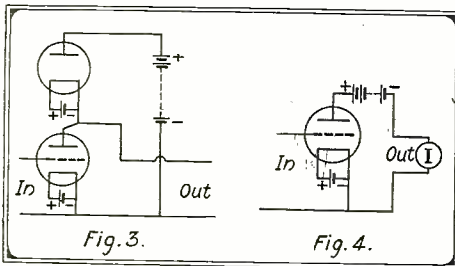

Two Extreme Methods of Using a V. T. for Magnifying Small E. M. F.'s or Currents.

A vacuum tube with hot and cold electrode, therefore, acts as a rectifier; such a tube is called a diode. This tube was introduced into wireless telegraphy by Prof. Fleming fifteen years ago and was known as the Fleming valve. Alternating current is rectified with great perfection by such a tube.

THE SPACE CHARGE.

In their flight from the hot cathode to the cold anode the electrons fill the space between the electrodes and constitute the space charge. The electric field which they produce tends to repel those electrons just emerging from the cathode back into that conductor. They produce in effect what may be termed a back E.M.F., which has to be overcome by the battery applied between anode and cathode. The main result is that the current is not proportional to the potential difference, but instead varies as the three halves power of the P.D. The number of electrons emitted per second from a hot conductor depends greatly on the temperature. The theory of the emission is analogous to that of evaporation, and agrees with the experimental results. For example, for tungsten, if the emission at 2,100 degrees Kelvin is 5 units, at 2,220 degrees it will be 25, at 2,300 degrees, 40, at 2,400 degrees, 110, increasing the more

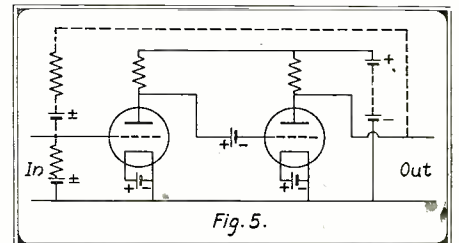

Cascade Amplification Where Intervalve Coupling is Effected By Means of Resistances.

adjusted to keep the current constant whether the key is up or down. This feat of transferring the grid voltage to the anode circuit after multiplication may be accomplished without the flow of appreciable current in the grid circuit, so that the current magnification is much greater than the voltage magnification, and the ratio of the power liberated in the anode circuit to that applied in the grid circuit is larger still. It is to these facts that the remarkable amplifying properties of the triode are due.

CASCADE AMPLIFIER.

When several tubes are assembled in tandem so that each magnifies the electrical effects passed on from its predecessors, we obtain what is called a cascade amplifier. These cascade arrangements are called "two-step," "three-step" and "many-step" amplifiers, according to the number of tubes employed, and many designs are in use. In classifying them it is found well to consider a single tube first and to observe that there are two extreme methods of using such a tube for magnifying small E.M.F.'s or currents. The first is the constant current method and is shown in Fig. 3. The second is the constant P.D. method and is shown in Fig. 4.

(Continued on page 478)

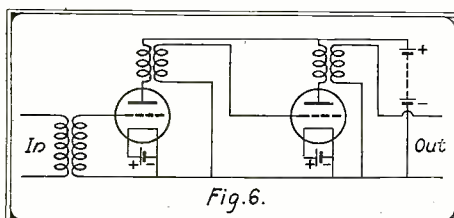

Cascade Amplification Where Coupling is Accomplished by the Use of Transformers.

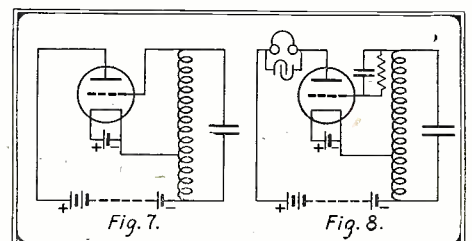

Fig. 7 is a Simple Generator of Oscillations While Fig. 8 is That of a Cumulative Rectifying Circuit.

*Abstract of lectures delivered before the Royal Institution, England.

Ideas--Eighth Spasm

By THOS. W. BENSON

IT is not without some hesitation that I write these paragraphs. In fact I doubt very much whether this dope is entirely new, it's just one of those obvious things that we bugs have been passing up every day. Everyone who has had occasion to pick up one of the early books on the subject of Radio has seen mention of spaced plates being used as aerials, noted the discussion of this type and then let the matter drop. No good, is the general opinion and my idea is that they are good, better even than the present type of amateur aerial and herein I propose to tell why I think so.

It is hardly necessary to go into much detail regarding the disadvantages of the present type of aerial, be it inverted L, T or single wire. They have remained practically the same since the birth of amateur radio. We still tie an indefinite number of wires an indefinite distance apart on a handy spreader and push them up in the air as far as we can without endangering the roof. Then we juggle with inductance and capacitance till it oscillates somewhere in the neighborhood of 200 meters. Of course, we have a collection of beautiful formulas to enable us to calculate the whole thing, but they are seldom, very seldom used. Constructional limitations design the aerial nine times out of ten. When we have finished we have nothing more nor less than a large condenser possessing some inductance and frankly it's a darn poor condenser considered from an engineering standpoint. I feel pretty safe in saying that the present aerial is all wrong.

Of course, we have the Underground aerial and still signs are copied. Does that mean anything? Just think a minute and see what Roger actually did when he buried the wires. Forget the relative position of the conductor and the ground and consider only what lies between them. The

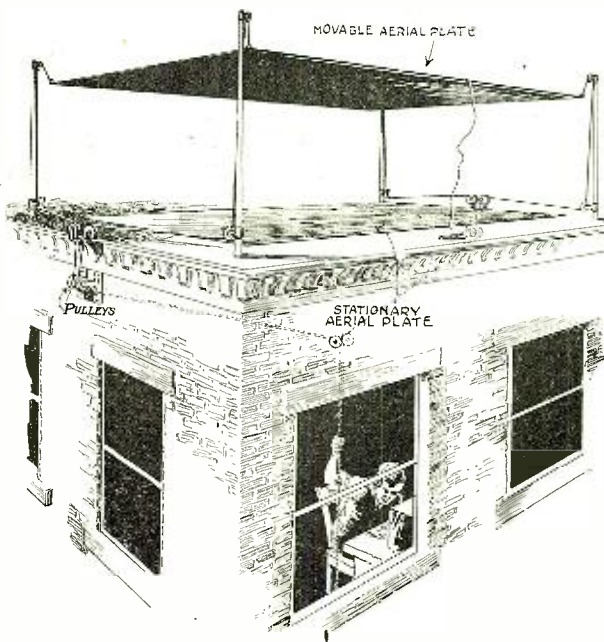

Amateurs What Do You Think of This? It is Merely an Aerial and Counterpoise of the Normal Type in Which the Space Between the Wires is Filled With Copper!

secret of his success lies chiefly in the fact that he used a homogeneous dielectric between the active plates of his condenser aerial. In other words he substituted a dielectric having well defined properties for one containing trees, buildings and other poor conductors such as he would have had in an elevated aerial.

It may be somewhat clearer when the aerial is considered as a condenser, its true function, with the wires as one plate, the ground the other. First there is bound to be more or less resistance not under our control, particularly in the ground. Consider also that the space between the plates

is occupied by building with metal pipes and other conductors. We are well aware of the losses incurred when dust gets on the plates of a variable condenser. But we persist in using a condenser in our aerial circuit that has all kinds of substances in the active field. We are warned not to use condensers with sharp edges or burrs on the plates on account of concentrated electrostatic fields at such points, still we have all kinds of iron work extending up from the ground in our aerial circuits. Think it over awhile and then perhaps you will agree that there really is something wrong with the aerials used today. But it can't be helped you say. Ah, there's the idea, *it can be helped*, and after reading this spasm I believe you are going to do it.

Coming back to fundamentals. The aerial is a condenser, then why can't we use two plates spaced three feet apart and large enough to get the capacity of a regular aerial, making connection to these two plates and doing away with a ground? We can then reduce the height of the aerial, a couple of six foot sticks on the roof would be plenty high enough; we can make it a good deal shorter and can control the resistance.

But you say the effectiveness of an aerial is proportional to its height. Very true. Were you to lower the present type of aerial no doubt it would reduce its efficiency. But we aren't lowering an aerial, we are building a new one, offsetting the lower height by reducing the resistance to practically nothing.

We must not overlook the importance of the reduced resistance. A "Plate" aerial made of metal screening or a number of wires can have all connections well made and with its higher capacity permit the use of a smaller inductance in series. With it to tune to a given wave-length the smaller in-

(Continued on page 496)

A. C. for V. T. Filament

By JOSEPH G. REED

Some time ago after sitting up until the early hours of the morning to copy Nauen and other European stations, I found to my despair that the filament storage battery had gone on strike owing to too much overtime work.

Previous to this I had given but a passing thought to the possible use of the house lighting current to heat the filament of the audion receiver but now had come the time for decided action in this direction. The supply current was 50 ~, 240 volt A. C., which seemed a hopeless case at first and liable to cause excessive interference.

Having a small low voltage transformer I connected it in place of the storage battery and was greeted with a terrific humming sound which completely drowned out even the strongest local signals. How to cut down this hum and reduce to a negligible factor is told in the following paragraphs:

To prove to the reader that the scheme is based on fundamentally sound principles we will go over the reasons for this humming sound.

Connect up the receiving set using the

regular storage battery and provide a switch to reverse the direction of the current. Tune in with the negative terminal connected to the grid lead, and then reverse the current. It will be noted that the signal strength is considerably changed. The reason for this is that an adjustment which gives satisfactory signals with a negative

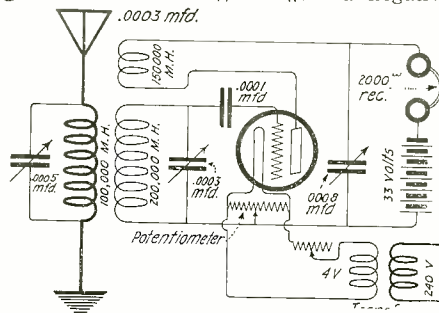

With a Small Step-Down Transformer and a Potentiometer, it is Possible to Get Rid of the Filament Battery by the Use of the 110V. A.C. Light Supply.

connection to the grid is completely upset when a variation takes place which alters the grid's potential, relative to the negative end of the filament.

If it were possible to make a center tap to the filament, the alternations of potential at its terminals would not effect the potential of the grid. This was tried out on a double filament audiotron bulb using both filaments in series, but as they were not exactly balanced the results were not at all satisfactory.

By connecting a potentiometer across the filament terminals the exact electrical center of the system so created was accurately located, and by connecting up the set as shown in the diagram the loud humming was balanced out by carefully adjusting the position of the potentiometer slider. A very slight humming exists at the minimum setting, but it is so faint that I find no difficulty in copying the U. S. Naval Radio Station at Cavite, Philippines (N. P. O.) in Sydney, Australia (about 4,000 miles), using a single audiotron bulb and a single

(Continued on page 489)

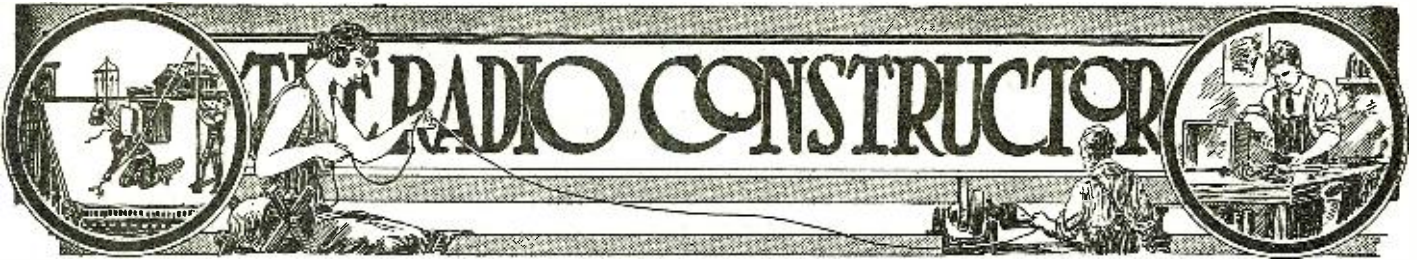

A Simple and Efficient Transmitter

By **FREDERICK J. RUMFORD, E. E.***

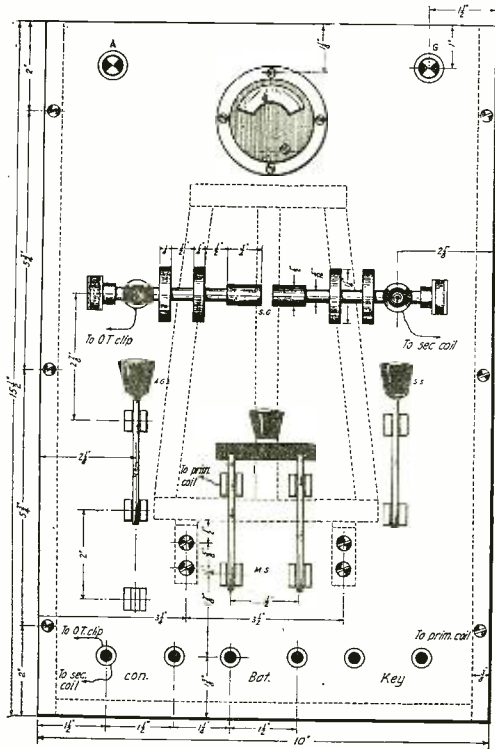

Front View of the Low Power Transmitter Especially Designed for Amateur Work. With This Set a Range of 12 Miles May be Obtained Under Good Conditions.

THE writer is going to describe a transmitter that is very simple and efficient and that will meet the demands of the average amateur. It will more than please the most exacting, in looks and workmanship appearance. The necessary parts for the making of this outfit can be picked up in most any radio amateur's workshop. If not, they can be purchased at most any radio supply house at a small cost.

All amateurs are aware of the existing radio laws in regard to transmitting radio telegraph messages on a wave-length of 200 meters, and when using a spark coil to have an oscillation transformer or helix in the aerial circuit. Briefly speaking, the law prohibits using over 200 meters and also prohibits the omission of a helix or transformer in the aerial circuit. No doubt, all amateurs are aware of this law. It is not the writer's intention to preach the radio laws but a word to the wise is sufficient. Therefore, it is advisable to use a wave meter to determine the exact wave-length that the below described outfit is working on before he throws his coil into his aerial circuit. A very efficient wave meter can be purchased at a reliable supply

house at a small cost and will meet immediate needs very well.

The writer would like to say that the oscillation transformer used in this outfit is a new idea, at least, the writer, in his years of association in the radio game, has not seen anything like the transformer described. He has spent considerable time and study on the outfit herein described and feels sure that the average amateur or "radio fan" making this outfit will get more than the usual satisfaction from it. One of the writer's friends has made up an outfit like the one described and has obtained very good results with it.

This set will do very well for the beginner who can't afford it or has not the means of using power tubes. In the course of time he will be using vacuum tubes for the transmission of radio telegraph and radio telephone messages, but this set will do as it will give him a good working knowledge of radio principles as a starter and also give him an insight into the working of the radio game.

The beginner must also thoroughly understand that he must not use this set unless he has an operator's license and a station license.

Fig. 1 represents the general assembly of the front view of the panel, showing the wiring which is on the back of the panel illustrated by the thick heavy lines. The dimensions are shown by the dot and dash lines, also, the exact positions of the various articles. As shown by the dotted lines are the oscillation transformer and the brackets. As will be seen in Fig. 1, there are six arrows. These signify that the respective wires are either soldered to an Eureka clip or connect with the apparatus mentioned at the back of the panel. The symbols O. T. represent oscillation transformers; S. S. meter shunt single-pole single-throw knife switch; S. G. spark gap; A. G. S., aerial and ground single-pole double-throw knife switch; M. S., main switch double-pole single-throw knife switch; R. A., hot wire ammeter.

Fig. 2 shows a side view of the outfit described. It also shows the method of mounting the oscillation transformer at the back of the panel and the method of placing the spark coil at the back of the panel.

Fig. 4 shows the general wiring diagram of the whole outfit connected up ready for use, including external hook-ups, along with the different symbols.

Fig. 5 shows a view of the oscillation transformer brackets.

Fig. 6 shows the oscillation transformer rods.

Fig. 7 shows the spark gap cooling flanges.

Fig. 8 shows the spark gap shaft.

Fig. 9 shows the tips for the spark gap.

Fig. 10 shows the uprights for the spark gap.

Fig. 11 shows the adjustment knobs for the spark gap.

The above figures have their own accompanying dimensions, so we shall now pass on to the making up of this outfit, starting with the panel and continuing on until the outfit is ready for use. The panel can be of oak, rubber, or bakelite. In this particular instance the writer has used oak on the outfit described as the amateur can obtain it cheaper than either of the other two mentioned. A piece of oak suitable for his needs may be purchased at an average of seventy-five cents or less. The dimensions of the panel in question are the following: 15½ inches long or high, 10 inches wide and ¼ inch or ⅜ inch thick. The panel should then be sandpapered to a smooth finish; it is then ready to be painted or varnished as the amateur prefers. A glossy black insulating compound has been used on the panel described with excellent effect.

The panel may be engraved designating the various switches. Now that the panel has dried, the next step is to mount the different switches, etc. The making of the oscillation transformer will be fully described later. The brackets can be made up out of ⅜ inch angle irons. The knife switches used on this outfit are of the ordinary kind and will make a very good appearance if they have been nickel-plated. The amateur will need the following knife

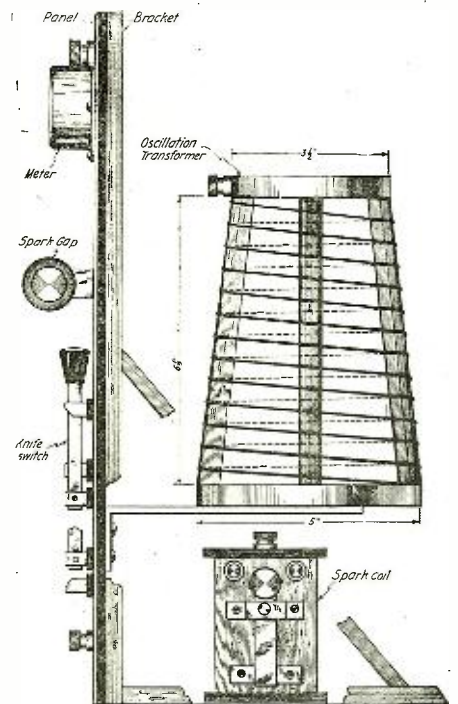

Side View of the Transmitter Showing the Oscillating Circuit and the Frame Holding the Panel.

*Rumford Radio and Electrical Engineering Laboratories.

Radio News for January, 1921

switches: one single-pole double-throw; one single-throw double-pole; and one single-pole double-throw for a radiating scale.

the spark gap five inches of and cut off two and drill each end $\frac{1}{8}$ inch so as to tap with a $\frac{1}{4}$ inch tap. Now $\frac{1}{8}$ inch hole, $\frac{1}{4}$ inch diameter and drill a hole in the center of them with a $\frac{1}{8}$ inch drill. The cooling flanges on the spark gap shown on Fig. 7. It is necessary to use two pieces of brass rod $\frac{3}{8}$ inches diameter and $\frac{1}{8}$ inch in diameter. One end of each of these rods must be turned down on a lathe to $\frac{1}{8}$ inch in diameter for a length of $\frac{3}{8}$ inch. The end that has been turned down must have a $\frac{1}{8}$ inch die run over it. The thread size will again be left to the amateur's own judgment. These are the shafts for the spark gap, as will be seen by Fig. 8. Now get two pieces of brass rod $\frac{3}{4}$ inch long and $\frac{1}{2}$ inch in diameter and drill one end on each of them in $\frac{3}{8}$ inch so that they can be tapped with a $\frac{1}{8}$ inch tap. This tap should correspond in thread size with the die that was used on the shafts; that is, so as the spark gap tips can fit tight to the shafts. These are the tips for the spark gap, as seen in Fig. 9. It is advisable to have all these gap parts nickel-plated before they are assembled. As to the assembling of the above, the writer would suggest that the amateur turn the tips onto the shafts very tight with a pair of pliers. He should then push the cooling flanges onto the shafts so as they fit snugly and are spaced one-half inch from the tips and one-half inch apart. He will then force the idle ends of the two shafts into the spark gap uprights. He is then ready to mount the whole assembly onto the panel front, as seen on Fig. 1. He will mount them by means of $\frac{1}{4}$ inch diameter machine screws from the back of the panel. The writer would also suggest that the amateur drill thru the panel into the uprights with a very small drill so as to allow the putting in of a pin into each of the uprights, so that there won't be any chance of their turning loose. He will now get two hake-

lite or rubber adjusting knobs to fit over the end of each of the shafts as seen in Fig. 11. The spark gap described above has given very good results and the cooling flanges were made big enough so as to offer a greater resistance to the heat caused by the rapidity of the spark passing from tip to tip, and then again, it offers a bigger cooling area. This spark gap if nickel-plated gives a more business like appearance on the panel front. To adjust the spark gap it will only be necessary to push or pull on the adjustment knobs. The knobs have been fastened securely onto the shaft, adjusting them to whatever position is desired. As will be seen a more delicate adjustment can be got by this method.

We now pass on to the making up of the oscillation transformer, which is a new idea in oscillation transformers, and which has given the writer and several of his friends very good results on the different tests it has been thru for the purpose of determining its worth. Procure two pieces of fibre, one five inches in diameter and one-half inch thick; the other, three and a half inches in diameter and one-half inch thick. These are the main supports of the oscillation transformer. Of course, other material, other than fibre, may be used. Now get four pieces of round fibre rod, one-half inch in diameter and six and nine-sixteenth inches long, as will be seen in Fig. 6. These rods are now placed between the two main supports standing upright, so that they slant, as on Figs. 1 and 2. They are held in place by eight wood screws, which are screwed thru the supports into the rods on each end.

Now give the whole assembly a good coat or two of some good insulating compound and let it stand for a couple of hours, until it is thoroly dry. Purchase about twenty or twenty-five feet of number six B & S. bare copper wire. This wire is to be used on the winding of the oscillation transformer. When this outfit is all made up and ready for use, be sure that you are not using over 200 meters.

Now to start in on the winding of this transformer, the writer would advise the amateur to have the turns spaced one-half inch apart thruout the whole winding. The way to do this is: Take the first rod and measure down from the top one-eighth of an inch and secure the wire. This is to be the starting. That end that is already secured must be connected to a suitable binding post. Now for the second rod; measure down from the top one-quarter of an inch and either drill a small hole to allow for the passing thru of the wire, or make a hack saw cut, so that the wire will fit into it. This will stop any chance of the wire moving up or down on the rods. The third rod should be measured down from the top three-eighths of an inch and the fourth rod measured down on from the top one-half of an inch, and by so doing, will make a start for the spacing of the turns one-half inch thruout the whole winding. Now then, as stated above, use holes or hack saw cuts in the rods for the placing of the different turns. After the amateur has the oscillation transformer all wound he should then have it secured very firm at the bottom of the winding on the bottom of the main support.

We are now ready for the mounting of the oscillation transformer on the back of the panel upon a pair of brackets. The writer will describe the making up of these. When mounting the transformer it should be kept in mind that the lower support should be just two inches away from the back of the panel upon its brackets. Having it any nearer may cause unlooked for trouble. The amateur should purchase two pieces of steel, six and five-eighths inches long, and one-half inch wide and one-eighth inch thick. He should then

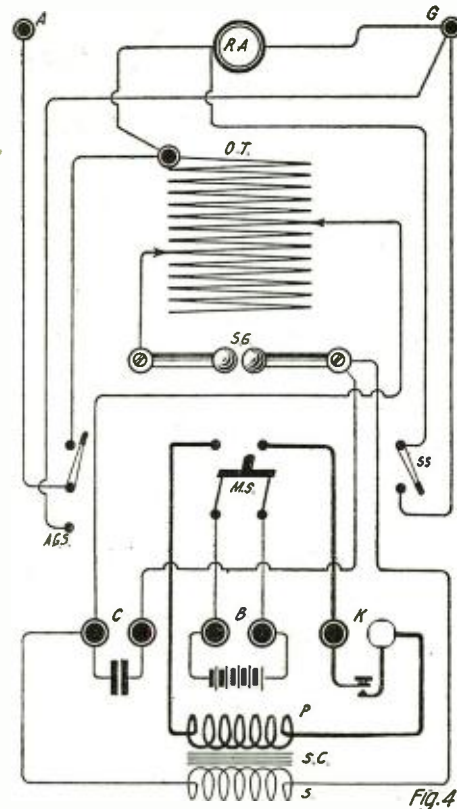

Wiring of the Panel; for the Sake of Clearness, the Vibrator of the Spark Coil is Omitted.

measure in three-eighths of an inch from one end of each of them and drill a hole large enough to allow a quarter inch bolt to pass thru.

He should measure in again from the center of the hole just drilled one and three-eighths inch and drill another hole the same size as the above. He will now turn to the other end on both of the pieces and measure in three-eighths of an inch. Then measure in from the center of that hole five-eighths of an inch. These holes are the same size as the above ones. Now take the end that has just been drilled and measure in one and one-half inch and mark. Place the pieces into a gas furnace or some other suitable heat over the marks just made and let them become a cherry red; then, take them out and bend them on that mark so as they will form an angle, as will be seen in Fig. 5. After these are cool, they are then ready to mount on the back of the panel by machine bolts. Mount the oscillation transformer upon these brackets, which will be held on them by means of bolts one-quarter inch in diameter and one and one-quarter inch in length. The connections on the oscillation transformer are made by means of clips which may be obtained for a few cents at any radio shop.

To tune the set at 200 meters, the clips connected to the spark gap and condenser are moved until the O.T. oscillates on 200 meters, this being controlled by a wave-meter placed nearby; the clips from the aerial are then moved until the ammeter shows the maximum intensity.

As seen in Fig. 1, the key connects onto the binding posts marked "Key"; the batteries onto the one marked "batt"; and the condenser onto the one marked "con." The condenser can be one of the ordinary transmitting ones. The shunt switch is for the purpose of shunting the meter when it is not in use. The aerial and ground switch is for the purpose of grounding your aerial when it is not in use, and the main switch is for the purpose of turning on and off the power. This outfit has been used successfully for over a distance of fourteen miles using a 1" spark coil.

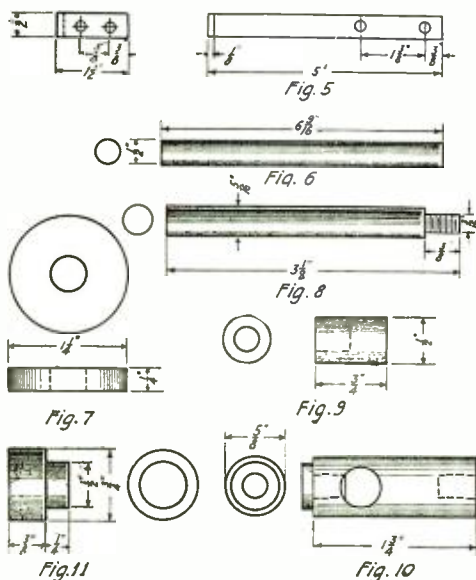

Drawing of the Different Parts Used in the Construction of the Transmitting Panel; These May Easily Be Made by the Amateur Having a Few Tools and Some Patience.

High and Low Spark Notes in Amateur Transmitting

By E. M. SARGENT

THE relative merits of the high and low spark notes, as applied to amateur transmitting work, have furnished a subject for discussion in radio clubs and magazines for some time past. During the war, and with the universal adoption of the 500-cycle quenched set by the United States Navy, the matter dropped from sight, but now that amateur transmitting has commenced again, interest in the question is reviving. Why is it, that in spite of the many square miles of printed theory to the contrary, the low musical rotaries continue to establish new 200-meter long distance records? Why does the high pitched non-synchronous amateur gap invariably give a rough note instead of a smooth

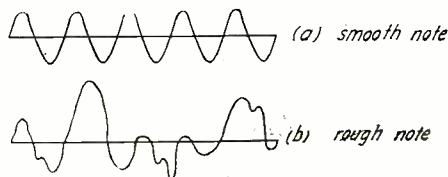

Fig. 2

Type of Oscillations Obtained with a Rotary Gap When (a) Well and (b) Badly, Adjusted.

500-cycle one like the ships? What makes those high rotaries "fade", and why do they come in so much louder when the current is shut off from the motor and it begins to slow down?

Or, to give the other side a chance why do operators working heterodyne receivers always tune in an arc so that it gives a 500-cycle note? Is it a coincidence that JOC, Otchishi, Japan, the only oriental 600-meter station which is heard with any regularity on this side of the ocean, has a 600-cycle note that cuts thru static and interference as if it didn't exist? These are a few of the most important questions, and they show that there is something to be said on both sides.

In the first place it is a generally accepted fact, proved both theoretically and by actual experience, that a smooth high-pitched note is easier to read thru interference than a low one. This is true for many reasons, two of which are that the receiver diaphragm and the human ear are both more susceptible to smooth vibrations of about



Fig. 6

Approximate Variation in the Wave Train Amplitude During One Cycle. Only a Few of the Wave Trains are Shown for Clearness.

900 per second than to those of lower frequency.

An equally true fact, also borne out by experience, but not so often heard from theoretically, is that a smooth low note is more readable thru static than a rough high one.

Figure 1 shows the resonance curve of a telephone receiver, the ordinates (vertical dimensions) representing the amplitude of vibration of the diaphragm and the abscissas (horizontal dimensions), representing the frequency. The source of power produced sound waves that had nearly the form of a sine wave. The frequency of the source was varied over the range shown and the resulting vibration of the diaphragm detect-

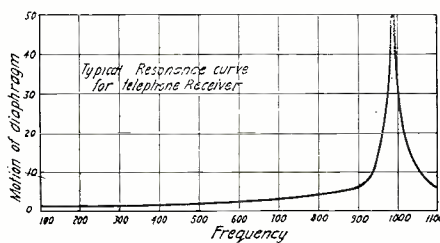

Fig. 1

Resonance Curve of a Telephone Receiver, the Vertical Dimensions Representing the Amplitude of the Vibrations and the Horizontal Dimensions, the Frequency.

ed. It is practically the same curve as would be obtained by magnetically exciting the diaphragm by passing a sinusoidal alternating current of variable frequency thru the receiver windings, and it shows that the amplitude of vibration, which corresponds to the "loudness" of the note is very much greater at resonance than at frequencies to either side. In this case the motion is 25 times as great at 900 cycles as it is at 450 cycles for the same applied power. However, the resonance curve is very sharp, and at 900 cycles the amplitude is only three times as great as at 450 cycles. The important point to remember is that this curve applies in one case only, that is where the exciting current is a sine wave, and if the wave form of the exciting current differs from a sine wave, the curve will be correspondingly broader and lower.

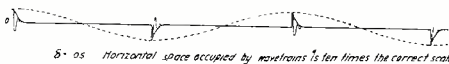

Fig. 4

The Dotted Line Represents a Wave of Same Frequency and Amplitude as the Telephone Current.

To make this clear, consider a small lead ball suspended from a peg by a string, forming a pendulum. Hit the pendulum a light blow. It swings from the center up to a maximum position, then back thru the center to the other side. At the instant it reaches its maximum position on the starting side, hit it another blow like the first one. It will cross the center again, rise to a new high position above the original one, then fall back and rise to a new height on the first side. Continue to hit it in this way being careful to strike it at the exact instant that it reaches its maximum height, and making each blow as nearly like the others as possible. The result will be that after 10 or 12 swings the pendulum will reach a fixed height above which it will not rise unless more force is put into the blows. Note this height. Now continue to apply blows of the same force but at irregular intervals, some coming before the ball has swung thru its full arc, and some after it has started to fall on a new arc. What is the result? The pendulum is swinging thru a much smaller arc than when the blows were properly timed. The case in which the blows were equally spaced and were of equal force corresponds to the sine wave current

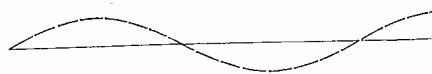

Fig. 5

The Little White Spots on this 60 Cycle AC Curve Show the Place Where the Spark Will Have to Jump in Order to Get 900 Sparks per Second.

in the telephone receiver, while case applies to a current such as produced by a rough note, and particularly such a current as is obtained from a synchronous rotary. It appears then that in order to get the most efficiency out of the pendulum or the telephone receiver it is necessary to apply a certain fixed frequency that is variable within small limits only.

A smooth note is one in which the time between all amplitudes is the same and in which all amplitudes have the same value. Fig. 2 (a) represents a smooth note, and Fig. 2 (b) shows a rough one.

The goal of every amateur is to transmit over the greatest possible distance with the

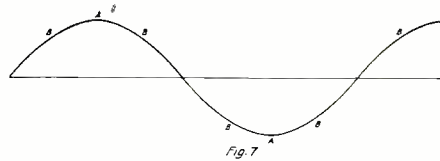

Fig. 7

Typical Curve of 60 Cycles A.C. To Obtain a Smooth Note the Condenser Should Be Discharged at Point A of the Curve.

power input of one kilowatt allowed by the government. The distance over which signals will travel depends upon the height of the sending and receiving antennas, the wave-length, the radiation resistance of the antenna and the current in the transmitting antenna circuit. Assuming that transmission is to be on 200 meters and that the heights of the antennae are fixed, the distance depends only on the sending current and the radiation resistance. If a radiation resistance is also assumed, the only remaining factor will be the current. It is therefore important to put the correct interpretation on the meaning of "sending current."

Suppose that an antenna is arranged so as to send out only one wave train when the key is closed, and that the first time the key closed, wave train (a), Fig. 3, was sent out and the second time, the circuit was adjusted so as to send out wave train (b), Fig. 3. (A) contains 8 watts and (b) one watt. Remembering that the distance travelled varies as the sending current, it follows that since the current in train (a) is



Fig. 3

Type of Wave Trains for High and Low Power. Train (a) Has a Greater Amplitude and Will Travel Farther Before it Becomes Inaudible.

larger, train (a) will travel farther than train (b), before being reduced to an amplitude at which it would just be audible. The input of the primary oscillating circuit has been assumed as one kilowatt or 1,000 watts. Then 125 wave trains such as (a) or 1,000 such as (b) could be sent out per second. But, altho one kilowatt of power would be radiated in either case and the hot-wire ammeter reading would be the same for both, the waves sent out in the first case would travel farther before being reduced to the audibility limit by reason of their greater amplitudes; other things being equal, a station using the for-

(Continued on page 493)

Radio Digest

CONCERTS

DeForest Radio Tel. & Tel. Co. is giving radio concerts between 7:30 and 8:30 every evening, except Saturdays and Sundays. These concerts are given on a wavelength of 1,400 meters, and a transmitting set radiating 5¼ amperes is used. The input into the tubes is one kilowatt.

The DeForest Company would appreciate receiving reports on these concerts from amateurs, stating what kind of receiver is used and the distance at which they are heard from New York City.

THE NATIONAL ASSOCIATION OF RADIO DEALERS

A new trade organization to be known as the National Association of Radio Dealers was formed last month, and has established temporary headquarters in Omaha, Nebraska.

The purpose of the association is to promote greater co-operation between the radio dealers, to give beneficial information and service to its members, and to bring the development of the radio industry to its maximum.

The most prominent radio firms are very enthusiastic about the association. The members of the official staff will be selected from some of the leading men in the radio field.

RECENT COMMERCIAL DEVELOPMENT IN WIRELESS

By Major H. MacCullum

In this very interesting article a complete description of transmitting sets is given illustrated by diagrams and photographs of the latest models.

The new Marconi spark set fitted with quenched gap and wave quick changing device is also described. A description of the valve amplifier used in the receiver of the C. W. is given as well as the details of connection of the 6 k. w. Marconi C. W. transmitter.—*The Radio Review, November, 1920.*

THE THERMIONIC VACUUM TUBE

By Van der Bijl

In a comparatively short time the applications of Thermionics have grown to a considerable extent, and are now not only of great value in engineering fields, but are also penetrating more and more into university and college laboratories. It is difficult for those who are interested in the subject, but who have not had the opportunity or the time to follow its development closely, to abstract from the literature, which has become quite voluminous, the principles of operation of thermionic vacuum tubes. This and the popularity, which the remarkable ability of these tubes to perform a great variety of functions, has gained for them, have created a need for a book describing in a connected manner the more important phenomena exhibited by the passage of electrons through high vacua.

In this work the author endeavors to set forth the principles of operation of thermionic vacuum tubes and to coordinate the phenomena encountered in a study of this field. Such a procedure is sure to result in a more valuable book than a detailed description without proper coordination of the many investigations that have been published on this subject.

The author has also tried to make the text sufficiently elementary to meet the growing demand for a book of this kind. This is especially the case with the first few chapters which must be regarded as very elementary and are mainly intended for

those who are interested in the applications of thermionic tubes and are not sufficiently acquainted with the properties and behavior of electrons to understand the operation of these tubes.

This book is published by the McGraw-Hill Book Co., Inc., 239 West 39th St., New York, N. Y.

WAVE-LENGTH RELATION FOR A GENERALIZED BESSEL'S ANTENNA

By A. Press

In this paper the differential equations for an antenna of negligible resistance and leakage conductance are set up. Proceeding from previously deduced values of the inductance and capacity per centimeter, along the antenna, the solution is obtained in terms of Bessel's functions for the voltage and current distribution along the antenna. After simplification, the solution is interpreted and curves enabling its ready employment are given.—*Abstracted from Proceedings, Institute of Radio Engineers.*

Radio Articles in the January Issue of Science and Invention

(Formerly Electrical Experimenter)

- The Geltow Radio Station.*
- Fleet Hears Opera Singer Via Radiofone.*
- Locomotive Cab Radio Signal.*
- Unique Portable Radio Set.*
- Girl Receives Election Returns by Radio.*
- The Oracle, Question and Answer Column.*

THE CALCULATION OF DETECTOR AND AMPLIFYING PROPERTIES OF AN ELECTRON TUBE FROM ITS STATIC CHARACTERISTICS

By G. Breit

The detecting efficiency of an electron tube is calculated in this article. It is assumed that experimental knowledge of the static characteristics of the tube is available. The constants of the circuits used with the tube are also taken as known and from these quantities, the average change in the plate current for a given amplitude, impressed grid voltage is derived. The impressed grid voltage is taken to be of the form $A \cos \omega t$ where A is constant. The case where A varies slowly is also discussed. The input impedance of an electron tube is calculated for the case of both positive and negative grid voltages, no assumption being made as to the mathematical form of the tube characteristics. The concept of the complex internal resistance is introduced in treating the amplification due to a single tube. This quantity is defined by

$$\Sigma \omega = \frac{I}{\tau \rho + \left(\frac{I}{j C_2 \omega} \right)}$$

where $\tau \rho$ is the internal resistance, C_2 the

grid plate capacity, $j = \sqrt{-1}$ and $\omega/2\pi =$ frequency. Similarly the amplification factor is generalized.

The condition for the vanishing of the incoming signal has been worked out. For the case of zero grid current this condition is just satisfied by tubes obeying Van der Bijl's relation.

It is also seen that the condition is not satisfied by the values of plate circuit constants predicted from the simple theory neglecting internal capacities.—*Abstracted from the Electrical Review, Nov., 1920.*

THE DETECTING EFFICIENCY OF THE SINGLE ELECTRON TUBE

By E. O. Hulburt and G. Breit

In this very interesting article the definition of the detecting efficiency of an electron tube is given. The method of measurement of the detecting efficiency by means of a condenser potential divider and sensitive quadrant electrometer is fully explained. In the first part of the article the formulas are given while in the second part the verification of theory by experiment is explained. This verification of the theory is verified qualitatively, showing the necessity of taking into account the capacities between the tube elements.

The sudden drop in signal strength observed with Armstrong's circuit has been explained also by the above theory.—*Abstracted from Physical Review, Nov., 1920.*

ON BEAT RECEPTION

By Meissner and Scheiffler.

The article contains a number of experimental curves concerning interference reception in radio-telegraphy and showing audibility as a function of received current and of superimposed current. When pyrite detectors were used, the audibility was found to be practically proportional to the received current. On the other hand, when the superimposed current was increased the audibility gradually increased toward a maximum value, decreasing for still greater superimposed current strength. Similar conditions were found when using an audion detector, in grid condenser connection. For large grid-leak resistances a limiting value of audibility was observed, which stayed constant, whatever the adjustment of the superimposed current, above a certain critical value; but for smaller grid-leak resistance the audibility curve showed a pronounced maximum at a certain value of superimposed current. Damped oscillations, it was found, can be amplified by interference reception if the following conditions are fulfilled: (1) The audion bulb must work at the lower bend of the characteristic curve. (2) The superimposed current must be out of tune with respect to the received current so that a phase change of 180 deg. will take place between two wave trains. Clear tones, however, could be obtained only for wave-lengths below 1,000 m. (decrement 0.04, 1,000 sparks per second).—*Abstracted from Zeitschrift für Fernmeldetechnik, Nos. 2 and 3, 1920.*

SHORE RADIO STATIONS

On November 15 the Lafayette Radio Station in France commenced working, and is now in communication with Otter Cliffs, which receives daily from Lafayette, Lyons, Rome, Nauen, Cayey and Balboa, and also communicates with ships at sea equipt with arc.

The Lafayette Radio Station was built during the war under the direction of the American Navy Department and was turned over to the French Government on the 18th of December.

Title Prize Contest

WELL, Boys, it's over! And we might add "never again"! When ye Editor first conceived the idea of this title contest it looked nice and easy, but before we got going the Post Office Department at Washington got after us for obstructing the mails on account of these titles! But, seriously speaking, this title contest was one great, grand, huge, howling 65-step amplifier success, with the accent on the howling. We have had other contests, but nothing like this ever happened before in the history of any technical magazine.

Promptly on the 10th of December, we had received by actual count 26,575 letters, but this did not by any means represent *all* the titles, for nearly everyone had at least an average of six titles which he or she suggested. So if you multiply this by 26,575, you get a slight idea of the job we carved out for ourselves so innocently when we embarked upon this high frequency title contest. Some people with a lot of time on their hands sent in *as many as 56 titles*, while others sent them in by telegraph, special delivery, registered mail and in person. There were even some received by telephone and a few by radio. None were received by express or freight. This surprised us greatly as almost every other method of transportation was resorted to. Besides after the 10th, several thousand more letters floated in, but by the terms of the contest these were not entered.

It became necessary to employ two extra clerks to assort the titles, and Ye Editor had to take home every night the proceeds of the day and read the letters over to seek out the original ideas. Among the twenty-six thousand odd titles you can readily imagine that there were but few really original ones. There were duplications galore, and of the twenty-six odd thousand titles there were at least 15,000 containing the word "shocking" in one way or another with little or no originality.

There were thousands of titles suggesting the words "Bridget, Maggie, or Sally" for the washwoman's name, doing some sort of a radio shimmy dance. Then there were several thousands of "S. O. S.'s" using the initials to tell us what happens to "Sally" or "Sarah." Then there were several carloads of "Q. R. M." and nearly every other

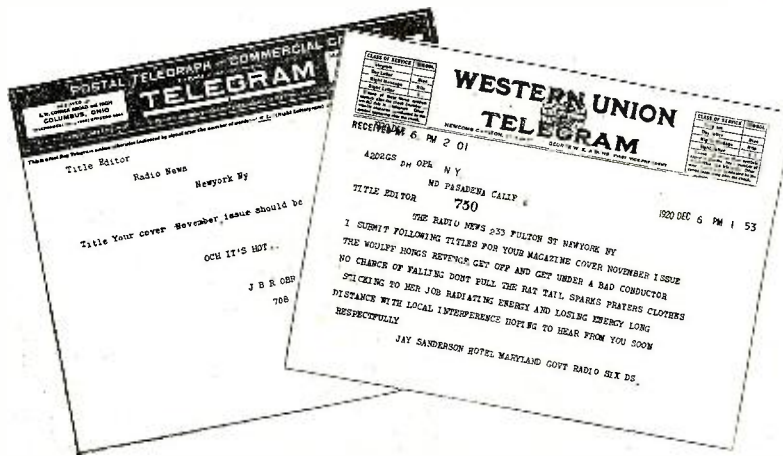

Twenty-six thousand five hundred and seventy-five (26,575) letters were received in response to our Title Contest announced in our October issue. Several thousand more were received after Dec. 10th when the contest had officially closed, and they are still coming in unabashed. Titles came in by letter, postal card, telegram, telephone, radio, etc., and the illustration shows two telegrams of the many received. It was the biggest contest we have ever held, and we congratulate the winners.

THE PRIZE WINNERS

FIRST PRIZE, \$25.00

"STUNG BY A WIRELESS BUG"

By John L. Hill
108 S. 32d St., Camden, N. J.

SECOND PRIZE, \$15.00

"YOUR WIRE TO HAND"

By Edwin D. Bell
238 Hunter St., E. Hamilton, Can.

THIRD PRIZE, \$10.00

"A TWO-STEP AMPLIFIER"

By M. Parsons
128 Duquesne St., Montreal, Can.

SPECIAL HONORABLE MENTION

"Stuck On Wireless," John C. Stryker, Newark, N. J.

"Stuck On Wireless," Lester H. Wagner, Milwaukee, Wis.

"Watts Grounded?" Edwin D. Bell, Hamilton, Can.

"Stung By a Radio Bug," R. Fangaroli, New York City.

"Stung By a Radio Bug," George Hower, Bethlehem, Pa.

"Grounds For Complaint," Herbert Noble, Jamaica, N. Y.

"Received In Full," George W. Gish, Riverside, Cal.

"The Grounded Washer," Harold E. Schulz, Cheboygan, Mich.

Honorable Mention

"Radio Activity," by C. Carlus Chez, Ogden, Utah.

"Radio Activity," by Herbert Blankle, Dorchester, 25, Mass.

"Radio Activity," by Richard J. Crane, Sandpoint, Idaho.

"Bridget Bridges a Hot Line," by E. P. Talbott, Indianapolis, Ind.

"The Leadin' Lady," by A. S. New, West Orange, N. J.

"A Line of Least Resistance," by Albert Salmon, Brooklyn, N. Y.

"The Line of Least Resistance," by Wellington F. Scott, Jr., Little Rock, Ark.

"Our Most Shocking Cover," by Joseph Wenger, Philadelphia, Pa.

"Woman Now Grasps All the Power," by J. H. Ellison, Richmond, Va.

"An Aerial Encounter," by J. H. Ellison, Richmond, Va.

"Save Our Sarah," by Warren Wood, Abilene, Texas.

"Grasping the News," by Walter Chas. Michel, Jersey City, N. J.

"An Advocate of Bill No. S3038," by R. A. Stratton, Philadelphia, Pa.

"The Wrong Hook-Up," by John Frazer, Ben Avon, Pa.

"Connection Broken—Washout On the Line," by Mary I. Houston, Toronto, Canada.

"Well Grounded Fears," by Joseph D. Lear, Buffalo, N. Y.

"Arm-Strong Circuit," by Herbert C. L. Lang, Cincinnati, Ohio.

"Radio News, Via Wire-less," by John Wm. Knight, Halifax, N. S., Canada.

"The Leadin' Rag," by Robert R. Rehm, Kansas City, Kansas.

"Kick Back Preventer," by A. J. Barron, Johnson City, Tenn.

"A Clothes Call," by Harry J. Jobert, Boston, Mass.

less received by Mars (Ma)," etc., etc. and we are sorry that not one of these could be awarded a prize. There were at least a thousand of these "Mars" variations, but it did not once occur to these contestants that while clever, the pun was more or less irrelevant as it really had not much sense to it.

Finally after December 10th, the whole 26,575 entries were boiled down into 12 original titles from which the prizes were selected. These represented the only original ones in the Editor's opinion, and we hope that everyone will be satisfied. We are also publishing a number of honorable mentions which came near winning prizes, but as times are hard and our prize money gave out, our friends will have to content themselves with the horrible mention, beg pardon, honorable mention. In closing, we might say that the title contest has proven a huge success; not only from the viewpoint of the interest that was displayed, but it proved a lucky financial stroke for us as well.

We have to pay out \$50.00 for the winning titles, but just having sold the 26,575 letters which represented two tons of paper, we realized \$59.59 on the paper and consequently were \$9.59 to the good!! Having paid this amount to the two extra clerks for six weeks of excruciating work, everybody is happy, and we proclaim hereby that everyone connected with the title contest will now be entitled to a front-title smile to which he may take title immediately.

Now watch for our next "Human interest" cover entitled: "Editor in a padded cell receiving titles!"

Radio News for January, 1921

lar.
George
"The
"The w.
etc. Furth.
several tons
tried to ingra.
selves with the
Editor by usin.
words "RADIO NEWS
the title somehow, but
this they failed. By
the time the 10th of Decem-
ber came around, and the
Editor saw the words
"RADIO NEWS" in a title
he blew a fuse, became
violent and had to be re-
strained from committing
murder. Then of course
we must not forget the
"Mars' (Ma) Messages"
of which we received a
goodly number. There
were "Ma's (Mars) re-
ceiving Wireless," "Wire-

"Ain't it a Grand and Glorious Feelin'," by R. Holmes Enley, Trenton, N. J.
 "Quite Regular Mondays," by Geo. H. Wise, Bangor, Pa.
 "She Only Shrieked," by Justus Liebig, Jersey City, N. J.
 "Radio Prohibition," by Harry D. Krug, Rochester, N. Y.
 "Ashes to Ashes and Dust to Dust, The Washtub Didn't Interest Her, But Radio Must," by Harry D. Krug, Rochester, N. Y.
 "A Short Cut to Radio News," by Mildred Wengel, Cuyahoga Falls, Ohio.
 "An Animated Antenna," by Everett Eckhardt, Wichita, Kansas.
 "Grounds for Trouble," by Gilbert H. McIlravy, Madison, N. J.
 "The Radio One Step," by Warren D. Wachter, Prairie du Chien, Wis.
 "Touching News," by Leonard Parthun, Milwaukee, Wis.
 "Electrical Experimenters," by Howard Dover, Longmont, Colo.
 "Watt Hertz?" by Chas. B. King, New York City.
 "The Call That Caused a Call Down," by Robert Riemenschneider, Chicago, Ill.
 "Big Overhead Charge," by J. H. Folley, New Orleans, La.
 "An Amateur Reaches Ireland," by Harold H. Robinson, Keyport, N. J.

"Sort Of Shocking," by Wm. G. Hyatt, Trenton, N. J.
 "The Line is Busy," by John Agar, Little Ferry, N. J.
 "The Line of the Least Resistance," by H. W. Waugh, Hingham, Mass.
 "Grounded Interference," by J. D. McGreger, Stamford, Conn.
 "Dancing Via Wireless," by Card R. Boyd, Ashley, Pa.
 "Fading Signals," by F. Krummel, Brooklyn, N. Y.
 "A Loud Speaking Receiver," by Harvey Connor, Philadelphia, Pa.
 "Her Own Hook-Up," by Wm. J. Elder, Bellevue, Pa.
 "Wash-out On the Line," by E. F. Preuss and A. J. Simandl, Milwaukee, Wis.
 "Radio Kinetics," by Ralph H. Squier, East Orange, N. J.
 "Damp Waves," by E. Ram Thomas, Darley, Pa.
 "Why Underground Aerials Are Preferable," by Howard J. Wendler, Roselle Park, N. J.
 "Going Into Wireless," by R. D. Washburne, Plainfield, N. J.
 "A Radio Dance," by R. D. Washburne, Plainfield, N. J.
 "Why Signals Fade," by Russell S. Morton, Salem, N. J.
 "Feeling a Message," by J. W. Pottorff, Grafton, W. Va.

"Bad" Radio Business

By ARTHUR H. LYNCH

The potentates of unrest and business pessimism have taken it unto themselves to vociferously exclaim, even in print, that business is "bum" and that it is going to be "bummer," but the writer has not been able to find proof of such a condition, even tho he sought it in a large number of radio places. His findings in the amateur field may be of interest.

A very prominent manufacturer of amateur radio apparatus, whose business headquarters are in New York, informed me, and there is every reason to have confidence in his observations, that his volume of business, for the year just ended, had been much greater than ever before in the history of his enterprise.

His business was started some eight years ago on a very small scale. The initial products were the direct result of his own handiwork and were marketed by him, during the time he could find between shifts in his shop. There is little use in explaining that his devices met with approval, when that is given to the fact that he is one of the largest producers of amateur and experimental apparatus in the world.

This fact is merely mentioned to indicate just how bum he thinks business is and what he thinks of the possibilities for the immediate future.

The size of his factory has been doubled within the past few months and it is not large enough to take care of the demands

which have already been made upon it and it will have to be enlarged again very shortly. In addition to enlarging his plant this manufacturer has purchased several thousand dollars' worth of new machinery, which he would hardly have done if he felt dubious about the continuation of demands for his products.

Undoubtedly the prices of commodities are bound to be returning to something like normal, but that is hardly going to reduce the demand for dependable merchandise, radio or otherwise. The war is over and labor is not as scarce as it was and the natural result is a decrease in the cost of raw products and even some of the manufactured products.

There is a lively competition in the experimental field which has already put a different face on the market. But it must be borne in mind that the declining of prices does not indicate dull business.

In order to point out even more strongly just what the conditions may finally eventualize into, it may be of interest to point out what radio folks in other parts of the country think of the proposition. A manufacturer in the South recently informed the writer that he has had to materially increase his helpers in order to cope with the demand and that his greatest difficulty is obtaining raw materials. In all probability the raw materials are reaching him now and from his advertising it would seem as tho he is almost ready to supply any

reasonable demand made upon him.

In order to find out what the feeling is among the supply houses, the writer secured interviews with several managers and found that altho the volume of their business was not as much greater than the holiday season of last year as they had figured on, it did not show any indication of any immediate alarming shut down. They seem generally to be of the opinion that there was not the usual Christmas rush, but that the annual dullness which always follows the holiday season will not be so pronounced this year.

A fairly good thermometer of conditions in any business is the business trade journal. A glance at the amount of advertising and comparing it with similar issues of previous months and previous years will give a rather comprehensive idea of the volume of business which is being done as well as that which is looked for during the months to follow.

Such scrutiny of the radio papers will disclose the fact that the amount of advertising carried by them for the month of December, 1920, was greater than ever before in the history of amateur radio in this country. Does that seem to indicate bum business?

Financial retrenchment under the changing conditions which obtain in the various markets to which radio must look for raw materials will undoubtedly have its effect

(Continued on page 496)

Announcement

MR. PIERRE H. BOUCHERON, who for the past year has been Associate Editor of RADIO NEWS, which position he held very successfully, has found it necessary to leave our editorial staff for other endeavors, much to our regret. Mr. Boucheron watched the magazine grow with us from 44 pages to nearly double that figure,

and his energetic endeavors had no little to do with the success of the magazine. We are extremely sorry to lose in Mr. Boucheron an exceedingly capable co-worker as his experience was as large as his knowledge of radio was diversified.

The duties of the Associate Editor have been taken over by Mr. Robert E. Lacault, who comes to us direct from the French

army, where he spent four years in the Signal Corps section. Here he secured very valuable information, much of which has not yet appeared in print.

Mr. Lacault is an expert on modern radio, and particularly vacuum tube amplification as well as all other branches of radio research.

THE PUBLISHERS.



WITH THE AMATEUR

THIS Department is open to all readers. It matters not whether subscribers or not. All photos must show efficiency of the apparatus, neatness of connections and general appearance. In order to increase interest we make it a rule not to publish photographs of stations unaccompanied by a picture of the owner. We prefer dark photos to light ones. The prize winning pictures must be on prints not smaller than 3 1/2 x 3 1/2". All pictures must bear name and address written in ink on the back. A full description giving full description of the station, aerial equipment, etc., must accompany the pictures.

PRIZES: One first monthly prize of \$5.00. All other pictures published will be paid for at the rate of \$2.00.

Station of C. A. Ulsh THIS MONTH'S PRIZE WINNER

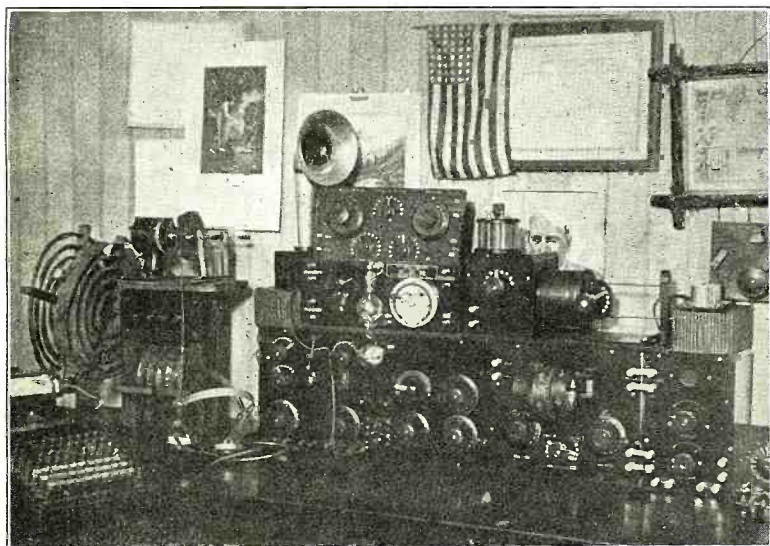

A very well-planned station you have Mr. Ulsh, and your home-made cabinet is very good looking and has a decidedly commercial appearance.

This radio station was built and is operated by C. A. Ulsh at Marion, Ohio. The apparatus was arranged in the best manner possible for quick and efficient operation.

Three aerials are used; an umbrella type for 200 meters; inverted L about 200 feet long and 70 feet high, and a single cable of

5 No. 14 copper wires 750 feet long and 40 feet high for the reception of long waves. This aerial together with a two-step makes it easy to copy the European arcs and some in Mid-Pacific on any schedule.

It was found by tests that a good ground is even more important than an elaborate

aerial system and it is surprising that most amateurs give to their aerials. I use five sheets of galvanized iron each 5 x 3 feet buried in a dam of a star shape and a lead taken from the dam. To insure good results the aerial is hooked onto a 3-inch well pipe 3 feet deep.

The best thing about the station is that the decrement is only 10 db. ever, the transmitter is a Winger closed core, primary with bakelite disc and a vibration transformer and denser mounted back of transformer.

At present I am planning an addition and radiofone using 4 power tubes and 100 volts D. C. The greatest trouble is to get the correct modulation on such a short wave.

A regenerative 200 meter set is used in connection with the umbrella aerial and for waves from 600 to 17,000 meters a set of Honeycombs is used which works great on all waves on and above 600 meters.

At present I have only a commercial license but hope to be in the amateur game in time for the best months.

CHESTER A. ULSH,
P. O. Box 380, Marion, Ohio.

George H. Hall Station

This station is installed at my home in Wigan, England. All instruments have been constructed by myself with the exception of telephones and valves. There are three complete receiving sets and various standby apparatus.

The set to the right tunes in all shipping and coast stations. The one in the center tunes in Paris, Poldhu, Cleethorpes, Chelmsford (Telefony) and all stations up to 4,000 meters. The large set on the left tunes all the great C. W. stations, European and American, such as MVV, POZ, OVI, YN, LCM, NSS, NFF and numerous others. Signals on this set can be heard all over the house. It tunes to about 20,000 meters. By a system of change-over switches I can throw any of these receivers over to the same headgear and also to the three stage audio frequency amplifier in the top right hand corner of the photograph.

I use the "Brown" reed receivers, 4,000 ohms, which are equal to another stage of amplification at the very least. The short wave set works with one stage of radio frequency and the three stages of audio frequency amplification just referred to.

All coil windings are hidden by thin sheets of hard rubber which give a professional finish. All my energies up

to now have been devoted to receiving, as the restrictions are so great on transmitting in this country. Just let them be lifted and you will be able to "taste" my signals in U. S. A. I have been a reader of RADIO NEWS since the first num-

ber (notice the cover pictures on the wall in photograph) and I must say it is a splendid magazine. I show it to all my friends and it is much appreciated here.

GEO. H. HALL,
135 Scholes, Wigan, England.

Altho they can't send with more than 10 watts they have some good stations in England. This receiving station of Mr. Hall's is entirely home-made. Look at it, bugs; nice, eh?

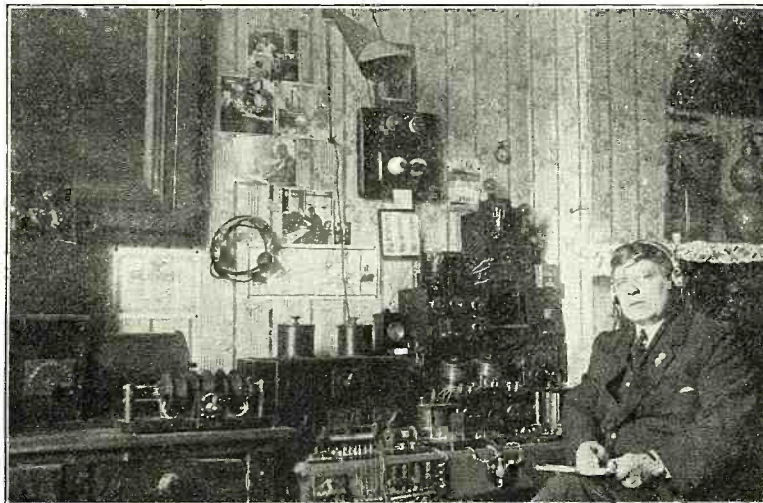

- "A 'Damp' Nuisance," by Fred Glaeser, Asbury Park, N. J.
- "Wired Wireless," by Charles C. Alword, Worcester, Mass.
- "Impact Excitation," by Chas. L. Sears, St. Louis, Mo.
- "Impact Excitation," by N. J. Becar, San Jose, Calif.
- "Impact Excitation," by J. N. Spurgin, Ottawa, Ill.
- "Hard Aground," by G. W. Smith, Jr., Philadelphia, Pa.
- "Wired Wireless," by Edward L. Friedman, Pueblo, Colo.
- "Getting a Hold on Radio," by J. R. Ball, Wilkesburg, Pa.
- "The 'Bridget' Interrupter," by Henry E. Fischer, Portland, Ore.
- "Innocence Abroad," by Forrest D. Bice, Ferndale, Wash.
- "Induct Dance," by Davis Crittenden, So. Swansea, Mass.
- "A Receiver Which Speaks for Itself," by W. S. Parkinson, Rutledge, Pa.
- "Receiving Off Hand," by Donovan Skirvin, Oklahoma City, Okla.
- "Skin Effect," by Geo. H. Matchett, Jr., Cleveland, Ohio.
- "Hot Stuff for the Grip," by R. G. Armstrong, Rockford, Ill.
- "Impulse Excitation," by F. L. Hopkins, Chicago, Ill.
- "Ain't it a Grand and Glorious Feelin'," by R. Holmes Enley, Trenton, N. J.
- "Quite Regular Mondays," by Geo. H. Wise, Bangor, Pa.
- "She Only Shrieked," by Justus Liebig, Jersey City, N. J.
- "Radio Prohibition," by Harry D. Krug, Rochester, N. Y.
- "Ashes to Ashes and Dust to Dust, The Washtub Didn't Interest Her, But Radio Must," by Harry D. Krug, Rochester, N. Y.
- "A Short Cut to Radio News," by Mildred Wengel, Cuyahoga Falls, Ohio.
- "An Animated Antenna," by Everett Eckhardt, Wichita, Kansas.
- "Grounds for Trouble," by Gilbert H. McIlravy, Madison, N. J.
- "The Radio One Step," by Warren D. Wachter, Prairie du Chien, Wis.
- "Touching News," by Leonard Parthun, Milwaukee, Wis.
- "Electrical Experimenters," by Howard Dover, Longmont, Colo.
- "Watt Hertz?" by Chas. B. King, New York City.
- "The Call That Caused a Call Down," by Robert Riemenschneider, Chicago, Ill.
- "Big Overhead Charge," by J. H. Folley, New Orleans, La.
- "An Amateur Reaches Ireland," by Harold H. Robinson, Keyport, N. J.
- "Sort Of Shocking," by Wm. G. Hyatt, Trenton, N. J.
- "The Line is Busy," by John Agar, Little Ferry, N. J.
- "The Line of the Least Resistance," by H. W. Waugh, Hingham, Mass.
- "Grounded Interference," by J. D. McGreger, Stamford, Conn.
- "Dancing Via Wireless," by Card R. Boyd, Ashley, Pa.
- "Fading Signals," by F. Krummel, Brooklyn, N. Y.
- "A Loud Speaking Receiver," by Harvey Connor, Philadelphia, Pa.
- "Her Own Hook-Up," by Wm. J. Elder, Bellevue, Pa.
- "Wash-out On the Line," by E. F. Preuss and A. J. Simandl, Milwaukee, Wis.
- "Radio Kinetics," by Ralph H. Squier, East Orange, N. J.
- "Damp Waves," by E. Ram Thomas, Darley, Pa.
- "Why Underground Aerials Are Preferable," by Howard J. Wendler, Roselle Park, N. J.
- "Going Into Wireless," by R. D. Washburne, Plainfield, N. J.
- "A Radio Dance," by R. D. Washburne, Plainfield, N. J.
- "Why Signals Fade," by Russell S. Morton, Salem, N. J.
- "Feeling a Message," by J. W. Pottorff, Grafton, W. Va.

"Bad" Radio Business

By ARTHUR H. LYNCH

The potentates of unrest and business pessimism have taken it unto themselves to vociferously exclaim, even in print, that business is "bum" and that it is going to be "bummer," but the writer has not been able to find proof of such a condition, even tho he sought it in a large number of radio places. His findings in the amateur field may be of interest.

A very prominent manufacturer of amateur radio apparatus, whose business headquarters are in New York, informed me, and there is every reason to have confidence in his observations, that his volume of business, for the year just ended, had been much greater than ever before in the history of his enterprise.

His business was started some eight years ago on a very small scale. The initial products were the direct result of his own handiwork and were marketed by him, during the time he could find between shifts in his shop. There is little use in explaining that his devices met with approval, when that is given to the fact that he is one of the largest producers of amateur and experimental apparatus in the world.

This fact is merely mentioned to indicate just how bum he thinks business is and what he thinks of the possibilities for the immediate future.

The size of his factory has been doubled within the past few months and it is not large enough to take care of the demands

which have already been made upon it and it will have to be enlarged again very shortly. In addition to enlarging his plant this manufacturer has purchased several thousand dollars' worth of new machinery, which he would hardly have done if he felt dubious about the continuation of demands for his products.

Undoubtedly the prices of commodities are bound to be returning to something like normal, but that is hardly going to reduce the demand for dependable merchandise, radio or otherwise. The war is over and labor is not as scarce as it was and the natural result is a decrease in the cost of raw products and even some of the manufactured products.

There is a lively competition in the experimental field which has already put a different face on the market. But it must be borne in mind that the declining of prices does not indicate dull business.

In order to point out even more strongly just what the conditions may finally eventualize into, it may be of interest to point out what radio folks in other parts of the country think of the proposition. A manufacturer in the South recently informed the writer that he has had to materially increase his helpers in order to cope with the demand and that his greatest difficulty is obtaining raw materials. In all probability the raw materials are reaching him now and from his advertising it would seem as tho he is almost ready to supply any

reasonable demand made upon him.

In order to find out what the feeling is among the supply houses, the writer secured interviews with several managers and found that altho the volume of their business was not as much greater than the holiday season of last year as they had figured on, it did not show any indication of any immediate alarming shut down. They seem generally to be of the opinion that there was not the usual Christmas rush, but that the annual dullness which always follows the holiday season will not be so pronounced this year.

A fairly good thermometer of conditions in any business is the business trade journal. A glance at the amount of advertising and comparing it with similar issues of previous months and previous years will give a rather comprehensive idea of the volume of business which is being done as well as that which is looked for during the months to follow.

Such scrutiny of the radio papers will disclose the fact that the amount of advertising carried by them for the month of December, 1920, was greater than ever before in the history of amateur radio in this country. Does that seem to indicate bum business?

Financial retrenchment under the changing conditions which obtain in the various markets to which radio must look for raw materials will undoubtedly have its effect
(Continued on page 496)

Announcement

MR. PIERRE H. BOUCHERON, who for the past year has been Associate Editor of RADIO NEWS, which position he held very successfully, has found it necessary to leave our editorial staff for other endeavors, much to our regret. Mr. Boucheron watched the magazine grow with us from 44 pages to nearly double that figure,

and his energetic endeavors had no little to do with the success of the magazine. We are extremely sorry to lose in Mr. Boucheron an exceedingly capable co-worker as his experience was as large as his knowledge of radio was diversified.

The duties of the Associate Editor have been taken over by Mr. Robert E. Lacault, who comes to us direct from the French

army, where he spent four years in the Signal Corps section. Here he secured very valuable information, much of which has not yet appeared in print.

Mr. Lacault is an expert on modern radio, and particularly vacuum tube amplification as well as all other branches of radio research.

THE PUBLISHERS.



THIS Department is open to all readers. It matters not whether subscribers or not. All photos are judged for best arrangement and efficiency of the apparatus, neatness of connections and general appearance. In order to increase the interest in this department, we make it a rule not to publish photographs of stations unaccompanied by a picture of the owner.

We prefer dark photos to light ones. The prize winning pictures must be on prints not smaller than 5 x 7". We cannot reproduce pictures smaller than 3½ x 3½". All pictures must bear name and address written in ink on the back. A letter of not less than 100 words giving full description of the station, aerial equipment, etc., must accompany the pictures.

PRIZES: One first monthly prize of \$5.00. All other pictures published will be paid for at the rate of \$2.00.

Station of C. A. Ulsh

THIS MONTH'S PRIZE WINNER

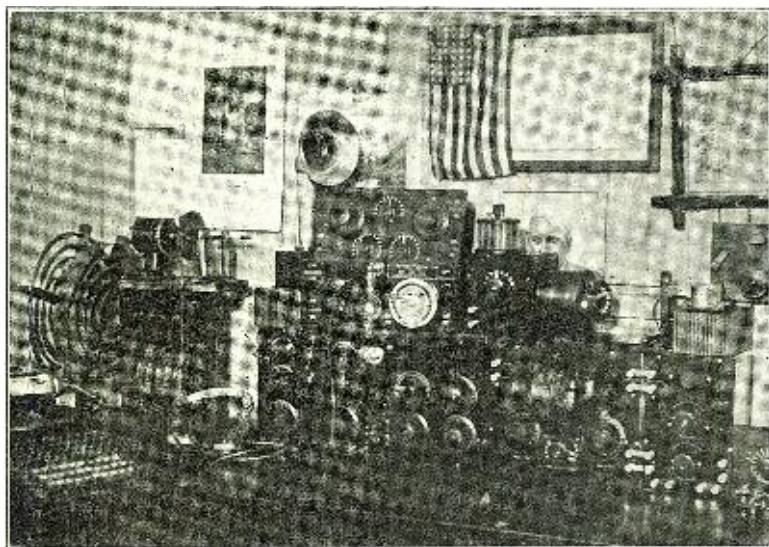

This radio station was built and is operated by C. A. Ulsh at Marion, Ohio. The apparatus was arranged in the best manner possible for quick and efficient operation.

Three aerials are used; an umbrella type for 200 meters; inverted L about 200 feet long and 70 feet high, and a single cable of

5 No. 14 copper wires 750 feet long and 40 feet high for the reception of long waves. This aerial together with a two-step makes it easy to copy the European arcs and some in Mid-Pacific on any schedule.

It was found by tests that a good ground is even more important than an elaborate

aerial system and it is surprising how little that most amateurs give to their grounds. I use five sheets of galvanized iron sheeting each 5 x 3 feet buried in a damp cellar in a star shape and a lead taken from the middle. To insure good results at all times, I hooked onto a 3-inch well pipe running 85 feet deep.

The best thing about the transmitter is that the decrement is only zero, as I lack the power to make the decrement higher. However, the transmitter consists of a ½ Kw. Winger closed core, non-synchronous rotary with bakelite disc and the familiar oscillation transformer and a Dubilier condenser mounted back of transformer.

At present I am planning an undamped set and radiophone using 4 power tubes and 550 volts D. C. The greatest trouble is to get the correct modulation on such a short wave.

A regenerative 200 meter set is used in connection with the umbrella aerial and for waves from 600 to 17,000 meters a set of Honeycombs is used which works great on all waves on and above 600 meters.

At present I have only a commercial license but hope to be in the amateur game in time for the best months.

CHESTER A. ULSH,
P. O. Box 380, Marion, Ohio.

George H. Hall Station

This station is installed at my home in Wigan, England. All instruments have been constructed by myself with the exception of telephones and valves. There are three complete receiving sets and various standby apparatus.

The set to the right tunes in all shipping and coast stations. The one in the center tunes in Paris, Poldhu, Cleethorpes, Chelmsford (Telefony) and all stations up to 4,000 meters. The large set on the left tunes all the great C. W. stations, European and American, such as MVV, POZ, OVI, YN, LCM, NSS, NFF and numerous others. Signals on this set can be heard all over the house. It tunes to about 20,000 meters. By a system of change-over switches I can throw any of these receivers over to the same headgear and also to the three stage audio frequency amplifier in the top right hand corner of the photograph.

I use the "Brown" reed receivers, 4,000 ω , which are equal to another stage of amplification at the very least. The short wave set works with one stage of radio frequency and the three stages of audio frequency amplification just referred to.

All coil windings are hidden by thin sheets of hard rubber which give a professional finish. All my energies up

to now have been devoted to receiving, as the restrictions are so great on transmitting in this country. Just let them be lifted and you will be able to "taste" my signals in U. S. A. I have been a reader of RADIO NEWS since the first num-

ber (notice the cover pictures on the wall in photograph) and I must say it is a splendid magazine. I show it to all my friends and it is much appreciated here.

GEO. H. HALL,
135 Scholes, Wigan, England.

Altho they can't send with more than 10 watts they have some good stations in England. This receiving station of Mr. Hall's is entirely home-made. Look at it, bugs; nice, eh?

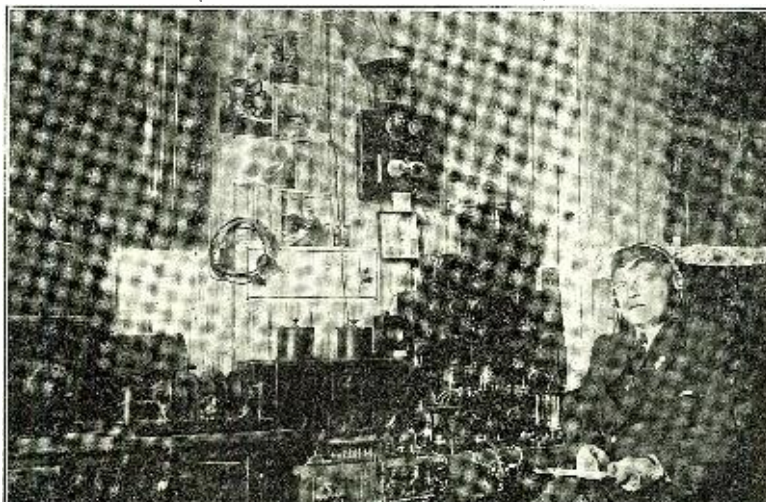

J. F. Zweighaft Station

I employ two transmitting sets, a fone and spark. The spark set is run from the 110-volt line with an electrolytic interrupter and a two-inch coil. Quenched gap or open gap may be used at will by means of helix clips. Resonance is attained by a home-made oscillation transformer and a hot-wire ammeter.

For shorter distances, I employ a fone set, with 220 volts on the plate. Two power tubes are used and the radiation varies between .5 and 1 ampere, according to the wave-length. The filaments are run by an 8-volt storage battery; a three-point switch controls the method of transmissions, voice, buzzer modulated, or C. W. As this set seems to be nearly as good as the spark set, I now use it almost exclusively.

Receiving is accomplished by De Forest honeycombs and a three stage amplifier of my own construction. These bulbs are run from a 6-volt battery and the plate current is furnished by the standard 22.5 volt "B" batteries.

I use two aerials, one 400 feet long and

Our compliments, Mr. Zweighaft on your home-made instruments. Your transmitting panel on the left of the photograph is fine.

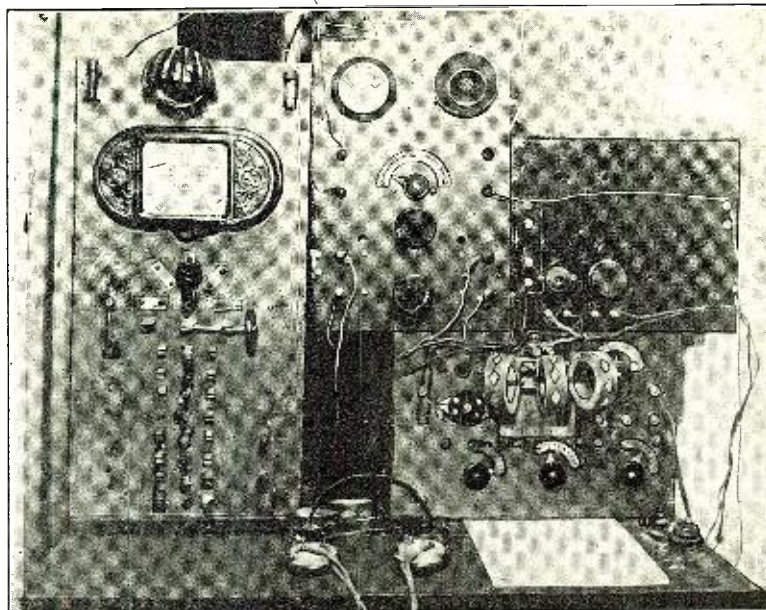

150 feet high for receiving, and another about 40 feet long and 80 feet high for sending. Both are made with a single

piece of wire, avoiding all joints.

J. F. ZWIGHAFT,
749 West End Ave., New York City.

W. L. Snyder Station

Below is a photograph of my radio station. I have constructed most of the apparatus at home, having a three-coil back mounted regenerative short wave set and detector combined, the short wave set constructed from an article by J. Stanley Brown in the March RADIO NEWS. The cabinet to the left is a long wave regenerative, using a V. T. Detector, with which I may switch a loose coupler for damp waves. The coupler is mounted on top of the cabinet, a one-step amplifier is placed on top of the short wave set, and my experimental Radio-fone which I haven't had time to test thoroly is to the right. I have not been very successful in the transmitting game altho I tried various transmitting sets and sold each in its turn. I now am using modulated C. W. and Buzzer on the sets. I have heard NAM, YN, POZ, FL, KET, NAR and KMT and KMK, the last two of Alaska. On the short wave and single bulb I get the 1st, some of the 2nd, 3rd, 4th, 5th, and 8th and 9th districts. 9ZD comes in

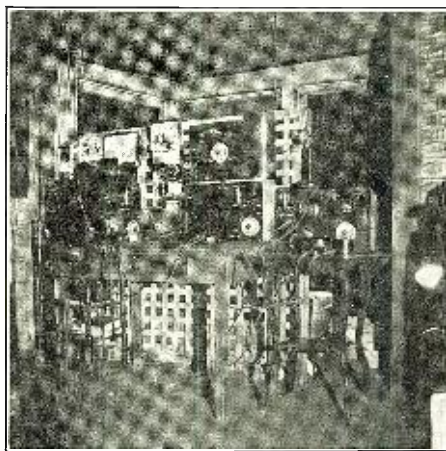

The Cage Behind Snyder's Apparatus is Not a Cage Aerial; It Is Merely the H.T. Room for the "B" Battery.

with a roar. Can hear 8ZW on a commercial wave any time he is on.

In the construction of my instruments I used bakelite panels and parts from E. I. C.° for I found that building my own apparatus saved me a lot of money beside the pleasure I had in making them. I found RADIO NEWS of great help in many cases and I really think it is the best magazine on the subject.

I would like to ask Mr. Editor to give us more dope on practical radiofone for short waves, and extend the Radio Constructor department.

My aerial is of the flat top type 70 ft. long and with 3 wires 3 ft. apart. I made a special ground connection which gives me good results and improved my reception. The ground is a thing to which amateurs don't pay much attention; they are wrong, for it is a good way to increase the ammeter reading.

My call is 8WC. WM. L. SNYDER,
Ridge Ave., Cunnensville, Pa.

J. Carlus Chez' Station

My receiving equipment consists of Brandes and Western Electric fones, home-made loud speaker, Audiotron and

cabinet with storage battery, and an NAA loose coupler, two variable condensers, fixt condenser, fixt variable condenser, De For-

est crystal detector, test buzzer, and loading coil all mounted in mahogany finisht cabinet built by myself. The loose coupler, as you will note, is mounted in the cabinet with openings for the slider and to permit coupling of the secondary. I find this a very convenient arrangement.

My transmitting apparatus consists of a Thordarson ¼ K.W. transformer, glass plate condenser, home-made rotary gap, Kermel hot-wire meter, Murdock oscillation transformer, and a Boston key. The connections are made thruout with copper ribbon.

A slate base aerial switch is used to make the change from sending to receiving.

I have not worked any great distance with my transmitting set but I get better results than some friends of mine with ½-K.W. My ammeter reading is 3 amperes, which is not bad.

My aerial is the umbrella type and is 60 feet high. With my receiving set I can hear NPL, NPG, NPK, NPW, the wireless fone at San Francisco, and many amateurs.

J. CARLUS CHEZ,
818 24th St., Ogden, Utah.

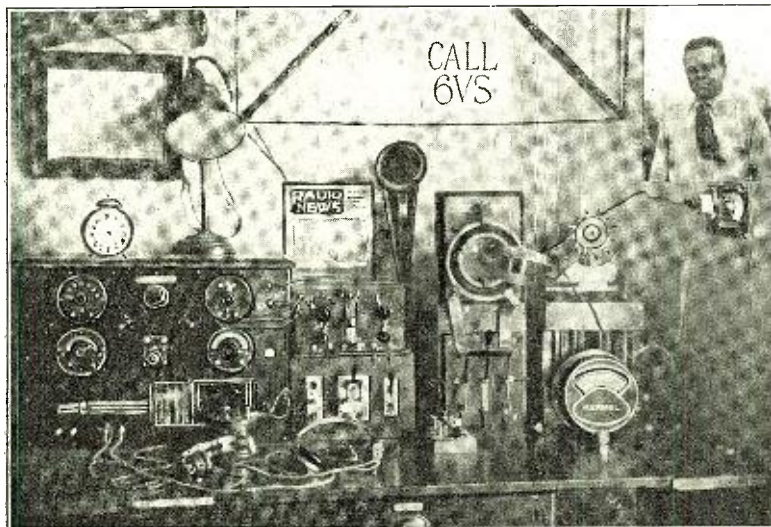

Here is a very well planned station, but some ammeter you have Carl; when the current enters it, it must take time to find the exit to the ground!

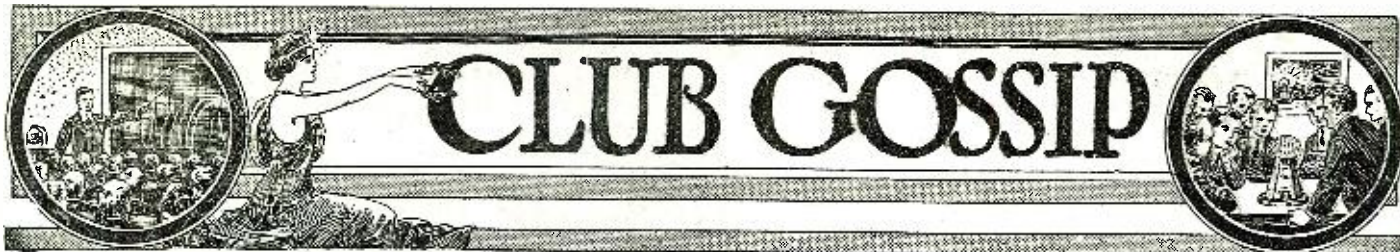

WALTON HIGH SCHOOL RADIO CLUB.

The Walton High School Radio Club was organized at the beginning of this school year and now consists of fourteen members. We are constructing a receiving station at the school house. So far our only receiving instruments are crystal detectors and fones. A loose coupler is almost ready for use and we expect to have vacuum tubes and amplifiers in the near future. Correspondence with amateurs and Radio Clubs is invited. Willet Bauman, Walton, Ind.

PORT JERVIS (N. Y.) CLUB ELECTS OFFICERS.

The regular weekly meeting of the Radio Club of Port Jervis, N. Y., was held at the wireless class room in the Y. M. C. A., and the following officers were elected: president, Lieut. T. H. Willers; vice-president, R. Whittingham; secretary and treasurer, R. Halstead. The club has a membership of nine regular members and thirteen students.

Instruction in radio is given by Lieut. T. H. Willers. On Tuesdays at 7:30 P. M., the students have radio lessons and code work and on Wednesdays at 8:00 P. M., the radio club full members have regular meetings and code work.

The yearly dues are \$2.00 for full members, who must be 16 or over and students are permitted free. Students are required to attend every Tuesday meeting and are given two weeks' grace; that is, no student shall miss more than two class nights at one time. If he does he is dropt from the list.

The Y. M. C. A. has given a room to the Radio Club for its meetings and classes, so at least the club has a home.

Correspondence from other clubs is invited. Address, Lieut. T. H. Willers, Inst., Radio Club, Port Jervis, N. Y. Care Y. M. C. A.

GREENFIELD (MASS.) CLUB ORGANIZED.

The Radio Organization of Greenfield, Mass., has been formed and the following officers elected: President, Donald Perry; vice-president, Dana Darling; secretary, Walter L. Campbell and treasurer, Stewart Nichols.

The meetings, until enough money can be raised to provide us with a club room, will be held at a different member's house each week.

We will be glad to correspond with any nearby amateurs or clubs.

Please address any correspondence to Secretary Walter L. Campbell, 113 School Street, Greenfield, Mass.

ROME (N. Y.) TO HAVE CLUB

A committee of four boys met at the Y. M. C. A. in Rome recently to talk over plans for the organization of a Wireless Club. The names of several who are interested in this work have been attained and it is expected that more will want to join. Chairman Elton Fitch explained some of the workings of the club and the desire to have a relay station in Rome. There is need of such a station located in this part of the state and the boys feel that they can put up an equipment which would be a credit to the city. The first aim of the club will be to have each member secure an amateur operator's license. The club will provide theoretical as well as practical knowledge of wireless. It is not necessary that a fellow know anything about wireless as long as he is interested in learning.

MT. VERNON (N. Y.) RADIO CLUB.

The wireless club of the boys' division of the Y. M. C. A. held a meeting recently, at which Mr. Howell, class director, gave a talk on magnetism and also gave the boys some code practice. A temporary set was installed and all members who had fones brot them to the meeting.

ESCONDIDO (CAL.) RADIO CLUB.

The Escondido Radio Club was organized at a recent meeting held in the Chamber of Commerce. Thirteen were present and took part in the organization.

Temporary officers were elected, as follows: Frank Axe, chairman; Paul Kroeckel, secretary-treasurer; Cyril Warren, publicity agent; Rudolph McDonald, sergeant-at-arms.

A committee was appointed to draft a constitution and by-laws.

Frank Axe was elected consulting engineer of the club.

Cyril Warren was elected instructor in elementary electricity.

It was decided to have code practice at every meeting.

Each member is to be given a special topic to prepare and give in the form of a talk, from time to time.

A rising vote of thanks was given to J. H. Heath for his kind donation of a room in the Chamber of Commerce for a permanent home for the club. In this room will be installed an elaborate and permanent "set" for the use of the club, the Chamber of Commerce and visitors to the Chamber of Commerce.

The club will meet regularly each Friday night at 7:30 P. M., at the club room. The club room will be open to members and interested visitors at all times. All persons interested are cordially invited to attend and become members.

Present at the opening meeting were Rudolph McDonald, Paul Kroeckel, Frank Axe, Arthur Buell, Arthur Nelson, Clinton Cook, Paul Williams, Hal Russell, Clare Rand, Aaron Holcomb, Dryden Beers and Cyril Warren.

STATEN ISLAND HAS RADIO CLUB.

The Staten Island club was organized on November 1, 1920, with a membership of ten and expects to have twice that amount by the first of the year. We have a practice table available for twenty members and we have secured an Omnigraph for practising the code. All members have receiving sets in working order. We hold our meetings every Thursday evening at 8 P. M. in Mr. George Gropp's Radio experimental laboratory on Osgood avenue, Stapleton. He is the president of our Radio Club and is fully appreciated among the members as a man who understands the radio game in every detail. The other officers are: Vice-president, H. Hitchcock; secretary-treasurer, G. Grabe. We expect to have a club set in the near future. We are paying dues at the rate of twenty-five cents a week which is not too much if you want to get along in a real Radio Club. Would like to hear from other radio clubs concerning organization or technical matters pertaining to Radio Activity. All amateurs who wish to join please communicate with Geo. Gropp, president, 24 Osgood Ave., Stapleton, Staten Island, or come down to the meetings any Thursday.

OREGON CLUB SHOWS PROGRESS.

The Washington High Radio Club of Portland, Oregon, which was formed Oct. 28, 1920, is progressing rapidly. Two of the fair sex have joined up to date and we expect more soon. Altogether we have about 25 members. Pretty good for a high school. Eh, what?

At present we have meetings every Monday directly after school and code practice every night. We are installing a complete transmitting and receiving set and will go into operation as soon as we can get a license.

Mr. Garrett Lewis, prominent amateur of this city, was elected president at the first meeting of the club. Other officers are: Richard Achison, vice-president; P. Jackson, secretary, and D. Cathcart, treasurer.

Address all communications to P. Jackson, 142 E. 39th St., Portland, Oregon.

KNOXVILLE (TENN.) HIGH SCHOOL BOYS ORGANIZE RADIO CLUB.

A wireless club has been formed at Knoxville (Tenn.) high school, which in the near future will enroll with the United States government, and receive an official code number. A meeting of those interested in that branch, was held recently and officers were elected as follows: Charles Cowan, president; Sam Wilkerson, vice-president; Hugh Simpson, secretary-treasurer; Philip Stout, radio engineer.

Most of the teachers were enthusiastic over the club, but only five were elected faculty advisors, on account of their help and suggestions. These faculty advisors are: Miss Plummer, Mrs. Rice, Mr. Evans, Mr. Hackney and Mr. Sineman.

An initiation fee is charged, and monthly dues are collected. There were some thirty members at the meeting and plans were formulated for the radio engineer to erect the aerial apparatus on the roof of the high school building. It has not yet been decided where the receiving apparatus will be installed.

It is planned to hold meetings of this organization on Tuesday afternoon of each week. The following committee was selected to draw up a constitution, of which John Aul is chairman. Members are: Elliot McNutt, Robert Collier, Wm

McGammon, Ed. Fogelsong. Most of the members of the club have been interested in wireless for some time, but the school only recently became an ardent supporter.

Several of the more active members gave a wireless demonstration. An aerial apparatus was installed on the roof and in one of the class rooms the receiving apparatus was placed. Different pupils of the school listened in and heard the messages.

LORAIN (OHIO) WIRELESS CLUB IS OUT AFTER NEW MEMBERS.

The first regular meeting of the Lorain Chapter of the Radio Club of America was held in the high school Nov. 24.

Any one in the city, interested in wireless telegraphy or telephony was invited to attend this meeting and join the local club.

The club now boasts of 26 members and officials are looking for a growth in membership in the near future.

Club members will meet and study the theoretical and practical sides of wireless. At different times papers will be prepared by the members upon new discoveries and inventions, and will be read at the meetings.

No examination is required to join the club at the present time, and the roll is open to anybody in the city, whether man or woman.

Besides being an educational club social events are also planned. Officials and members of the club are planning on a big year for the club and are anxious to enroll every person in Lorain and vicinity who is interested in wireless work.

THE RADIO RESEARCH ASSOCIATION

The Radio Research Association has been formed by the former members of the Scientific Research Club, a pre-war organization.

The club is installing a short and long wave receiver, a spark transmitter and a C.W. set.

The technical committee of the Radio Research Association is composed of experienced radio men.

We are forming a junior class for amateurs who are not of age yet to enter the senior organization. Instruction will be given both in code and theory.

It is the purpose of the club to experiment in the field of radio and it will be beneficial to all interested in radio to communicate with us.

Meetings are held every Saturday at the Henry Street Settlement, 303 Henry Street, New York City.

All communications should be address to the secretary, B. Hoffman, 233 South 3rd Street, Brooklyn, N. Y.

ONONDAGA SCIENTIFIC SOCIETY

On Dec. 6, 1920, fifteen amateurs of Syracuse met at the local Y. M. H. A. and formed the Onondaga Scientific Society.

The following officers were elected: Solomon Posen, president; Benjamin Quitt, vice-president; Nathan Meltzer, secretary; Jacob Rubenstein, treasurer, and Leon Adelman, instructor.

We are now in full swing and it is the club's sole desire to put Syracuse on the radio map with a bunch of live wire amateurs that will be an asset to the art.

We meet Monday night. All interested are cordially invited to drop in sometime at one of our meetings. Our clubrooms are at the Y. M. H. A., 222 Cedar Street. All wishing to join please notify the secretary, Nathan Meltzer, at his home, 1036 Montgomery Street.

Correspondence from other clubs is invited.

THE MILWAUKEE AMATEURS' RADIO CLUB

The Milwaukee Amateurs' Radio Club has started the present radio season with two big ideas: First, one big radio club for the city of Milwaukee and to make it the first section of an organization of affiliated Wisconsin radio clubs; second, to run a campaign for the betterment of radio traffic conditions in the vicinity of Milwaukee. The club has absorbed the local membership of the now defunct Wisconsin Radio League and plans are being made for the organization of a Wisconsin Amateur Radio Association. A set of traffic rules and regulations has been approved and will be enforced by the club thru its Committee on Interference and Relay and the A. R. R. L. City Manager.

A new meeting place has been secured thru the courtesy of the School of Engineering of Milwaukee.

(Continued on page 491)

CORRESPONDENCE FROM READERS

SAYS RELAY WORK RANKS IN IMPORTANCE WITH EXPERIMENTING

Editor RADIO NEWS:

Have read *Electrical Experimenter*, RADIO NEWS and some copies of *Modern Electrics*, and have found them quite "Jake." However, others say the same thing that I am going to say, so I'll have to drop in line—you print some very good matter and some "punk" stuff, also mostly good matter. If it was all good, we might get tired of the magazine. *The most interesting feature is your extremely broad field.*

Some people take different views on the subject of amateur radio work. You, and some of your contributors, also, appear to place relay work and the handling of "free" messages under the category of child's play. While I agree with you that there is no value in amateur radio unless experimenting is done, as the mere handling of relay messages will quite likely get tiresome, after one has been at it steady for some years, I do not see how you figure that relay work could be dispensed with. There have been several bills against radio amateur work introduced into Congress. It was certainly not any advance in science caused by experimenters of the common or garden variety that helped to kill these issues. The United States public has, by now, become used to the handling of free radio messages. This was what made the general public notice the value of the radio amateur. On the other hand, of course, if there didn't happen to be "experimenting" amateurs like Mr. Armstrong and others, the short wave regenerative set, long range 200 meter transmitters, etc., would not be here, and we would still be using 2,000 ω fones, loose couplers and carborundum or silicon detectors and sending with 20-inch spark coils on plain aerial, etc. Back again—where would 2XG, 2XJ and 2XX, be with their short wave fone tests, if it had not been for the relay, or "DX," men who were regularly doing long distance work, so we're on the job? What would have happened if Bob Trump had been fooling with a 100,000 meter loose coupler trying to get Mars, or experimenting with some contraption to send pictures thru the air when there was no breeze blowing? Well, a fine DX record would not have been made, and 2XG would not have known what had been misst. I am not strictly a "DX" man yet, and am forced to do some "experimenting" to find out just what kind of apparatus will work best up in this country.

I cannot understand, Mr. Editor, why you put experimenting up any higher than relay work. To my mind, the one cannot do without the other, so both are equally important. What do you think now?

H. S. GOWAN,
Kitchener, Ont.

Having digested the above missile, and having felt our pulse after sticking a few pins into our editorial wisdom, we are beginning to wonder just where our friend has obtained the impression that RADIO NEWS thinks more of experimenting than of relay work. We immediately put a few gross of our associates to work upon back numbers of RADIO NEWS, and after they read them backward and forward, inside and out, and after the said copies had been inspected with the spectroheliograph, coupled to a 10½-stage amplifier, as well as the X-ray, they report that they have found no trace of any such harsh illusion and that the statement does not appear to be quite "jake."

However, and whomever that may be, if there is an impression prevailing that

RADIO NEWS tries to knife all relay work, let it be stated here that such was never the policy of the magazine. If our good friends will send in their manuscripts to us relating to relay work or anything affiliated to it we shall be only too glad to open such a department for our readers.

We have also in the past received some letters where amateurs asked us why we did not print "calls heard" by the various stations, etc. We always thought that while such matter might be interesting, we had an idea that our readers looked to us for "real live news" and things of general interest, leaving other publications to cover the former information.

However, if our friends think that we should publish such matter in the columns of RADIO NEWS, and if it is their wish that we should do so, why, of course, we will oblige them. If our readers, therefore, will let us know, we shall soon find out the drift of the matter and as usual the majority will win.—Editor.

YOUTHFUL AMATEUR ENTHUSIASTIC ABOUT DEPARTMENTS FOR JUNIORS

Editor RADIO NEWS:

Just a line to tell you how much I enjoy RADIO NEWS.

I get it at a nearby news stand almost every month. I am a 14-year-old boy and am very much interested in the "Junior Section." I think this section is a great help to young amateurs, and I think that your Junior Radio Course is fine!

Most of the fellows around here feel the same way about your magazine, and I hope you will appreciate it.

JOHN GLOVER,
Grosse Ile, Mich.

COVER FIRST ATTRACTED HIM

Editor RADIO NEWS:

It was with great disappointment that I read the letter from our Georgia friend in your November issue regarding RADIO NEWS covers. I have been a news stand subscriber to your valuable magazine since almost the first issue and I have watched and admired the phenomenal growth of this publication. *It was the cover that originally attracted my attention.*

We, in the show game, know that a serious melodrama is very attractively offset by a good lively comedy and such your human interest covers do to the more serious matter contained in the inside.

We all know that good constructive criticism is essential and accepted but I, for one, have no use for the "brick bats"; therefore I say more foolishness on the cover and less in the inside!

Yours for 100,000 copies per
FRED G. CURTIS,
Crescent Theatre, 1450 E. William Street,
Decatur, Ill.

ABOUT FADING SIGNALS

Editor RADIO NEWS:

In the October issue of RADIO NEWS I read two views on fading signals. My view is an altogether different one. I think, altho interference waves may exist, fading is due to the same cause as freak signals.

If fading were due to interference waves there would be a distinct regularity to it, because the re-radiated wave would neutralize the incoming wave, and the incoming wave would never reach the antenna; therefore no new wave could be re-radiated. This would produce an almost perfect beat in the fading, while it is a fact that fading is rather irregular.

In large bodies of water and in the atmosphere there are ever-changing currents; for instance, the Gulf Stream. It does not take exactly the same course the year around. Why could there not be similar currents in the ether?

Now I think there are and that these currents in the ether vary exactly like air currents. In this way, the conducting medium might at one moment pass right by the antenna and the next moment hit it, thus producing fading.

I don't think fading has anything to do with charged bodies of vapor in motion because it is comparatively more noticeable on cold clear nights. These same ether currents might produce freak signals by passing around a nearby station and reaching one a greater distance away.

I don't think the existence of ether currents has been duly considered before. If a small piece of apparatus like a one-inch coil can disturb the ether for a considerable distance, think what can be produced by the great forces we know are in existence.

EDWARD J. HEFELE,
2279 Washington Ave., Bronx, N. Y.

"RADIO NEWS BEST EVER"

Editor RADIO NEWS:

I have been a reader of *Electrical Experimenter* for over three years and always thought it was one of the best magazines published. When you came out with RADIO NEWS I thought it would have to be some magazine, to beat *Electrical Experimenter*. After having been a subscriber for one year, I must say that the RADIO NEWS has first place in my estimation and I could not get along without it.

I am saying a lot when I say that almost all I know of radio I got from the RADIO NEWS. Some record! Eh? Not only that but I have constructed most of my wireless apparatus and have done so only by seeing how in RADIO NEWS.

You ask for constructive criticism. I don't see how anybody could improve on the perfect. Whenever there is anything that I want to know, I know where to find it. If it hasn't been in any of the RADIO NEWS it soon will be. Such is my confidence in it.

WILLIAM BINFIELD,
Kenmare, N. D.

APPROVES OF OUR COVERS

Editor RADIO NEWS:

In looking over my November RADIO NEWS I took good notice of Mr. Maher's letter in regard to the picture on the cover of September RADIO NEWS. In my opinion Mr. Maher is one of those scientific men who judges magazines by their covers.

When RADIO NEWS was first published it was under the name of *Radio Amateur News*. This was not a very appropriate name for it, as it greatly exceeded plain amateur news. I have collected much scientific knowledge from it, but I think every magazine needs some "pep" and fun and it's my opinion the covers of RADIO NEWS help to supply this. If this magazine had only real "highbrow" scientific articles in its pages, which the amateur could not understand, I presume Mr. Maher would highly recommend it, but the amateur would not, and as the magazine is, was, and I hope will continue to be for the amateur, let it have matter that he can understand, with a little humor thrown in.

Whether I have some to stand by me, or whether I stand alone I say, "Let RADIO NEWS be as it is, and be successful as it has been ever since it was first published."

F. W. BRAUTLECHT,
Yardley, Pa.

A Phony Phone

By VOLNEY G. MATHISON

SAMUEL JONES, the old, shellback operator banged unceremoniously into the office of his friend Cunningham.

"I sure thot I was doomed for the dippy-house this last trip," he declared, rather irrelevantly, as he helped himself to a seat in the inner sanctum.

"Guess you always were a little disarranged in the top story, anyway," retorted the San Francisco man, with an amiable grin. "What did you do this time—swallow a quart of moonshine and dream you were the Sultan of Turkey?"

"No such darn thing!" exclaimed the old-time brass-pounder, with assumed indignation. "This yarn's got nothin' whatever to do with wine an' women—that is, not's far as I'm personally concerned in it, anyway."

"Humph, that's funny," teased Cunningham. "You're usually tangled up with one or the other of those same."

"Well, I'll lay you a bet," offered the veteran code-juggler, calmly disregarding the other's gibe. "I'll tell you this just as it happened, an' I'll wager you a feed to-night down at the hang-out, that you'll not be able to guess the answer. Are you on?"

"Oh, I see! You've got it all figured out, cut-and-dried, to ring me in for the eats, eh? But, anyway, I'm on. Have a smoke." Cunningham produced a box of cigars.

"You know I don't use them," retorted the shellback, fishing out his sack of Durham and a book of papers. Deliberately, he rolled a smoke and accepted a light.

"It makes me laugh, now," he chuckled, half to himself. "But it sure had my goat for a couple of days." He took a drag on the cigarette and rested his elbow comfortably on the arm of his chair.

"You know, about ten days ago I went up to Seattle to bring the *Sepulpa* down to San Pedro. She's a shippin' board arc, an' got one of them tuners with a audion settin' in behind a little door on the starboard side of the darn jigger. Seemed like I couldn't hear nothin' on the blame thing when we gets out to sea, so I drags out my old reliable audion-panel an' starts to hook 'er up. I digs up a blue-print of the navy tuner, an' it was such a confounded mess of freak wirin' an' choke-coils an' a lot of other signal-preventin' fixin's that I couldn't make out how I was goin' to hook in my own panel without wreckin' the fool rig.

"I was most ready to give it up when all at once I gets the idea of leavin' the tuner the way she is an' just hangin' my audion onto her like a one-step amplifier. Not havin' no transformer, I decides to rig up a resistance-coupled amplifier. I takes the fones off'n the tuner an' runs a wire from one of the fone bindin'-posts to one side of the filament on my own panel. Then I starts to run another wire from the other bindin'-post to the grid of my audion, when I happens to remember that I got to put some kind of a condenser in here to keep the detector plate-battery from knockin' my amplifier grid-potential all out of joint. So I gets out one of my kodak films an' peels off the wax-paper an' tinfoil wrap-pin's. I cuts the foil into two pieces an' puts 'em between the wax-papers an' wraps the whole business round a empty film-spool. That fixes the condenser.

"Next, I makes a resistance element out of a piece of cardboard with a bunch of pencil-marks on it, an' slaps it down between the two fone bindin'-posts on the tuner.

"Then I switches on the A battery an' don't hear nothin'. Somehow, I gets a hunch that my resistance-unit's no good, so I pulls off the cardboard rig an' bridges the tuner bindin'-posts with my thumb an' finger, at the same time liftin' my feet off'n the iron deck. An' then the signals comes in a roarin'.

"I notices that if I don't pinch the bindin'-posts pretty firm, the signals would sort of fade, an' if I grips 'em too hard the signals would go right out. Had to squeeze just hard enough to get the right resistance adjustment, an' no more. An' I had to keep my feet clear of the deck, too.

"We was about seven hundred miles from Pedro, but NPX was comin' in strong an' so was everybody else along the coast. After a while, I gets tired of listenin' on six hundred, so I gives the condenser knobs a swing an' what does I hear but a voice, comin' in thru the spark signals.

"Course, there's nothin' specially surpris-

hangin' onto my fones with the other an' keepin' my feet lifted up in the air, in comes the old man.

"'Sufferin' Smokes! What th' hell's th' matter!' he hollers out, starin' at my strikin' pose. 'Is there a ship sinkin'?"

"'No,' I answers, takin' a breath. 'I'm just tryin' to get the address of a bunch of spirits.'

"'What kind o' spirits?' he asks.

"'Alcoholic,' I tells him, briefly, an' he goes away.

"I gets a new resistance adjustment on the tuner bindin'-posts, but the man's voice was gone an' static was startin' to come in heavy. Seemed like I could hear a lot of girls' voices or somethin', but I couldn't make nothin' out of 'em thru the interference, an' I gives it up. I figures that if the fone is in Frisco, I'd likely get it better the next night, when we'd be right abeam of the Golden Gate.

"The next evenin' I finds it again, all right, but it was weak now, an' I could barely hear it thru all the racket 'round Frisco Bay. I thinks to myself that the fone must of been up north some place, after all, but I didn't have no time to worry about it just then because we run into a lot of fog, an' I was busy as a monkey scratchin' fleas, takin' a bunch of compass-bearing's around the Faralones.

"The followin' mornin' we was way down towards Point Arguello an' I'd most forgotten about the queer fone. After breakfast, I was up on 'O' with my arc, gettin' cleared. When I gets thru, I drops down on six hundred with my receiver, an' was tunin' around, careless-like, when in comes that blasted fone again, strong and clear!

"A girl with a voice like an angel playin' on a harp was talkin' to some fellow she was callin' her beloved darlin' an' precious sweetheart an' enough more endearin' names to fill a dozen pages in a lover's instruction-book.

"'Did I get you out of bed, calling you so early in the morning, dearest?' she asks him, in a voice that was so sweet it sounded like somebody was pourin' a pitcher of honey into my ears.

"'No darlin', I hears a mushy, sissified-soundin' gink answerin'. 'I've been sittin' here claspin' your angelic picture to my bosom since five this mornin', hopin' an' prayin' you'd ring me up, my precious little tootsie wootsie.'

"'You darling boy! I could just kiss you to death for that!' exclaims Miss Peaches an' Buttermilk. 'You does love your little tweetums, don't you, Reginald dearest?'

"'Course I love you!' says the fool simp on the other end of the line-less line, talkin' like a young pig eatin' bran an' clabbered milk.

"'I love you, I love you, I love you,' he repeats, over an' over, like a phonograph with the needle stickin' in one groove.

"'Oh, you glorious, wonderful, angel boy! his affinity answers, makin' the air most drip with sweetness. 'I'm going to send you a great big kiss right over the fone.' I hears a kind of a long, burnin' soul-kiss come driftin' thru the ether. It was so real I could feel my ears turnin' red an' startin' to smart.

"Right in the middle of all this, all of a

(Continued on page 497)



A Girl With a Voice Like an Angel Playing on a Harp Was Talking to Some Fellow She Was Calling Her Beloved Darling and Precious Sweetheart and Enough More Endearing Names to Fill a Dozen Pages in a Lover's Instruction Book.

in' about that, nowadays, but we was more'n three hundred miles from Frisco, an' that was the nearest place where I knew of there bein' any wireless fones. I tunes in the voice an' hears a man talkin'.

"'Is it the same as the last bunch I got?' he asks somebody, who I couldn't hear answer.

"'All right, if it's hundred proof, I'll have ten quarts,' he says next, an' I clamps my fones down hard.

"'No, you got to quit leavin' it in that wood-shed,' was the next I hears. 'The hired-man found it there last time.'

"'I was thinkin' what a lucky guy the hired man was, when the fellow speaks again.

"'I should say he did get drunk,' he says, kind of peevishly. 'He got so darn drunk he went down-town an' tried to kiss the mayor's wife, right on the main street.'

"'I seems to hear somebody laughin' then, but I wasn't sure.

"'Yes, he's still in jail,' the man says, next.

"'I didn't hear nothin' more for a couple of seconds an' I was digestin' all this foregoin' conversation, when he comes in again.

"'Put it under the hedge behind the chief of police's garage,' he says.

"'While I was sittin' there manipulatin' that resistance-grip with one hand an'

The Mystery of the Damp-Undamp Messages

By Herbert L. Moulton

THERE he goes again!" cried Hendon, as the call "TVA TVA TVA de LVL" softly vibrated thru the ether. "If that's really Guatamala City calling, why do you suppose they're using 26,000 meters?"

"I don't think it is Guatamala City, Bill," his chum Lopez replied, as he pressed the spare set of receivers to his ears, "because the letters 'TVA' have never been assigned to a station. I think someone is posing as LVL and using this high meterage for the sake of secrecy."

The soft ripple of dots and dashes that had spelled out the call for TVA now ceased, and William Hendon tuned his apparatus to all the varying degrees of wave length with the hope of picking up LVL's answerer. Down to 600 meters: scores of ships at sea talking among themselves, or dispatching a routine message to the shore: down to 200 meters—that "open territory" for those hosts of students of the radio science. Sometimes these latter signals amounted to a hoarse buzz; sometimes an enterprising amateur announced his etheric arrival with a shrill shriek.

Thru this army of polyglot messages, however, came no call for LVL. Up again to 26,000 meters. A silence. Despite his efforts at adjustment, his instruments recorded no sounds from out the strangely silent ether.

"Guess they're all thru for tonight," Hendon said, as he turned off the current of his tube filament and closed the ground switch.

Lopez said nothing, but took the receivers from his head and placed them upon the table.

"Come around tomorrow night, Vin, and we'll see what happens," Hendon invited, as his chum walked toward the door, "and in the meantime—KEEP IT MUM!"

Promptly at 9:10—the usual time—the next night, Hendon and Lopez sat at the former's table in the little radio room.

The instruments were set for 26,000 meter damp wave reception. Several minutes passed, during which nothing disturbed

the silence of the room but the hurried breathing of the two interested radioists.

Suddenly, without warning, faint, pulsating vibrations of dots and dashes sounded in their receivers. Starting out with a low moan, the sounds rapidly climbed upward in tone until their pitch was that of a flute. Hendon ascribed this initial variation in tone to a rotary gap, the operator of which had started sending the message before the rotating member of the gap had reached its maximum speed.

"— . . . — . . ." they heard three times, then, "— . . . — . . . — . . ." "TVA TVA TVA de LVL!" Again the impossibility of closer tuning, again the rapid search thru all the different wave-lengths for the reply, if one there was. He prayed for a five-step amplifier he had read about in one of the radio magazines; he prayed for anything that would enable him to receive the answer to this strange call.

As if defying him, however, the ether was again silent when once more Hendon had brot his wave-length up to 26,000 meters.

Again the heavy ground switch was closed for the night and the two lads separated, each one intensely interested and pondering over a solution of this mystery.

It had been raining hard all day—a rare occurrence in Juanista, Arizona—and Lopez did not appear for his usual nightly visit, so Hendon was alone in his radio room. Try as he might, the ether was strangely unresponsive when he tried for 26,000 meter damp wave reception. Hendon's enterprise almost cost him his vacuum tube, for while endeavoring to put it in the most receptive condition he allowed a trifle too much current to go into the tube filament, but a lucky glance at the ammeter in the panel warned him in time. Chagrined, he resolved to waste no more time upon this mysterious station, and accordingly turned his efforts toward picking up a certain foreign arc station he had found to be very elusive in the past. Forthwith, he turned the little switch in the panel from "Spark to Arc," brot his wave-length down to 15,500 meters, and listened in. Silence . . . was his tube oscillating? He brot the filament rheostat around to zero and then gradually raised the voltage again. Yes, it was oscillating now.

A very faint, high-pitched squeak com-

neglected to change over his Arc-Spark switch.

With almost incredible speed, the little switch was snapt over from "Arc" to "Spark." As if in commendation of Hendon's conviction, the flute-like notes that indexed LVL sounded in his receivers. The faint scratch he had just heard on the undamp circuit now became audible dots and dashes, at a speed between 80 and 90 words a minute!

Hendon could "work" nicely with anyone at 20 or 25 words a minute, but his mind was unable to translate the code when sent four times that speed.

Not being able to read the dots and dashes that piled up on each other at this amazing speed, he contented himself with merely listening to them, his mind turning over the question that had just possessed him. Why should two radio stations communicate with each other under such vastly different circumstances? For commercial traffic such a system was, to say the least, very inefficient, but for secrecy . . . such communication would,—if secrecy was

paramount,—be almost as private as if sent in the most intricate code. Codes, he knew well, were capable of being deciphered.

Thus it was that he cogitated upon these subjects until at last the smooth ripple in his fones died down to the ever-present static. Swiftly he brot his wave-length down to 16,000, snapt the little Arc-Spark switch over to "Arc," busied himself with getting his bulb oscillating, and then waited for TVA. Again the high-pitched squeak, but nothing was said that would give him an insight into the character of the 80-90-word-a-minute message, just an acknowledgment, then silence.

"What the Sam Hill have you got there?" were the first words Lopez uttered when he entered Hendon's room the following night. "Are you tryin' to send music by radio?"

"Nope, it's just an old dictating machine I borrowed from Bob Harris at the First National. Now don't ask me what it's for—you'll see in about five minutes."

Hendon had hooked a loud-talking receiver to the mouthpiece of the dictating machine, connected this receiver up with his receiving apparatus, and finally adjusted the dictating machine at its maximum speed. Now he awaited LVL's pianissimo of dots and dashes to play in his receivers, including the fone that was connected up to the dictating machine.

A few moments later Hendon's ears heard the now-familiar call: "TVA TVA TVA de LVL" his undamp circuit recorded TVA's answering squeak, and then LVL began its automatic tape transmission of the night's message. Hendon was ready. His day's labor had not been in vain. Deftly, he set the cylinder of the dictating machine in motion, and calmly sat back in his chair, drawing on his pipe meditatively.

"Here, Vin, see what you think of this," Hendon said as he handed his head-fones to Lopez. The latter put them on; his features registering amazement, as he heard the smooth, pulsating ripple of LVL.

(Continued on page 498)

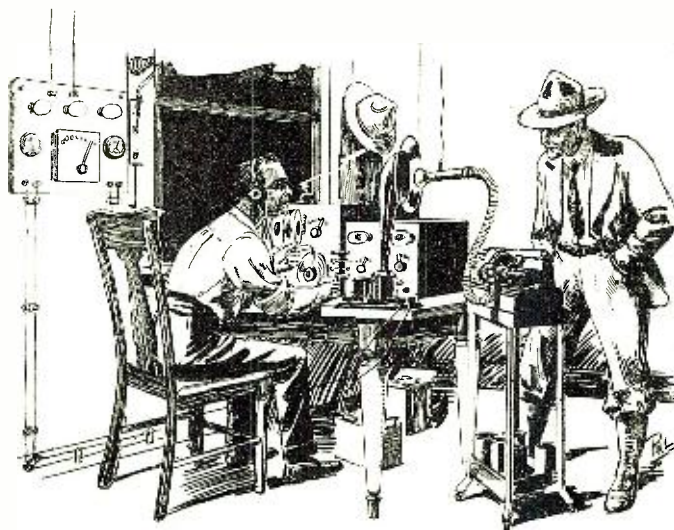

Hendon Had Hooked a Loud Talking Receiver to the Mouthpiece of the Dictating Machine, Connected This Receiver up with His Set and Adjusted the Dictating Machine at its Maximum Speed.

elled his attention. He had not heard this station before. Who and where could it be? The signals were too weak to be readable and his condenser adjustment brot him no better results, save perhaps, to make the squeaks a trifle higher-pitched. A few turns on his loading inductance switch, however, brot the signals within the range of interpretation, until at 16,000 meters they were at the maximum intensity.

"..... de TVA" he translated!! Feverishly turning his loading inductance switch about again until the dial read 26,000, he listened for the flute-like note of LVL. A silence, broken only now and then by a bit of static. A scratching sound stirred in his fones, but he gave it no attention.

And then he remembered!! The previous nights, when he had heard LVL, he had used his spark circuit. He had just heard TVA on his arc circuit. The whole scheme of things dawned upon him. One station communicated with the other at a high wave-length, using a spark set, while the other answered with an undamp outfit at a comparatively low wave-length!! The reason he had never been able to hear TVA previous to tonight was because he had



Junior Radio Course

The Three-Element Vacuum Tube, 2nd Part

THIS lesson is the third on the subject of vacuum tubes. In the first one was described and explained the theory of electrons. In the second, the three-electrode vacuum tube and its use as a detector was explained. In this lesson the functioning of a three-electrode vacuum tube as an amplifier will be demonstrated.

It has already been explained that the grid in a vacuum tube acts as an interrupter, when it is made alternately positive and negative, as well as the phenomena which takes place in the rectification.

It is known that according to the ratio of the number of turns between the primary and the secondary of a transformer, the voltage applied on the primary is increased in the secondary in the same proportion as the number of turns, but the intensity is inversely decreased.

The amplifying transformer being built on the same principle, it is easy to see what will happen in an amplifier by referring to Fig. 1, which represents the hook-up of a one-stage audio frequency amplifier.

When the rectified current from the detector circuit is applied on the primary of the transformer, a corresponding voltage is induced in the secondary. This voltage changes the potential of the grid and this opens and closes the plate filament circuit as has been explained in the previous lesson.

These impulses in the plate filament circuit, make the telephone diaphragm vibrate with a great amplitude, for the current interrupted is of a greater intensity owing to the higher voltage of the "B" battery used in the amplifiers.

If, instead of the telephone, the primary of another amplifying transformer is connected in the plate circuit the same process will be reproduced in the second stage of amplification, where the secondary of this transformer is connected to the grid of the second vacuum tube, but with a still much greater intensity.

Altho this explanation is simple enough to be understood by every student, we will illustrate the phenomenon of amplification by a simple analogy.

ANALOGY

In Fig. 2, the endless pipe represents the plate filament circuit. The faucet F when open represents the filament lit up. The tank P represents the plate, and the cylinder

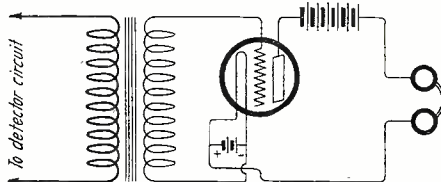

Fig. 1
Hook-up of a One Tube Audio Frequency Amplifier. If Other Stages of Amplification Are Added the Primary of the Second Amplifying Transformer is Connected in Place of the Fones.

in the center is the grid.

Now the lever Tr represents the amplifying transformer. The part of this lever which is between the axle and the left pivot is the primary, while the longer part between the axle and the right pivot is the secondary. As can be understood, a small swing of the shorter arm will make the longer arm swing with a proportional greater amplitude. This represents the ratio between the primary and secondary of the transformer.

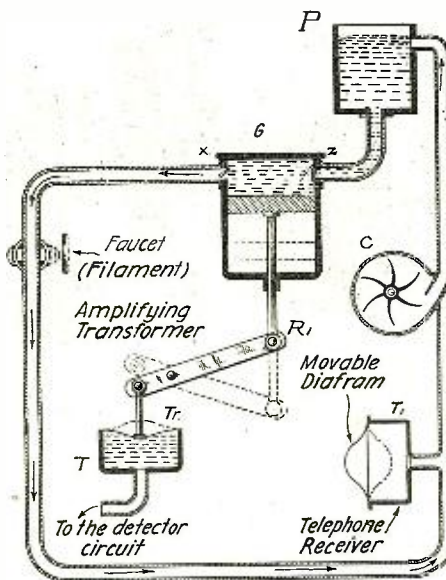

Fig. 2
Here is a Simple Analogy by Means of Which Every Student May Understand the Phenomenon Happening in a V.T. Amplifier.

If this lever is used to move the piston in the cylinder representing the grid, the piston will have a long run when the shorter arm of the level is pulled and pushed by means of the rod fixed on the diaphragm forming one side of the little tank T.

Two valves open and close the supply of water, and the exhaust pipe, at each stroke of the piston; the little tank having a movable side shown by Tr represents the telephone receiver.

When no variation of the pressure occurs in the little tank T the position of the lever is as represented by R₁ and the piston is at top of the cylinder. Both of the valves are open and a flow of water, kept in motion by the rotary pump C, runs in the endless pipe.

When a variation of pressure occurs in the little tank T, the diaphragm closing it vibrates up and down; this up and down motion makes the piston also move up and down but with a greater amplitude. When coming down it closes the valve X, and opens in full the valve Z, filling the cylinder with a part of the water contained in the tank P. When going up, the valve Z is closed and the valve X opens, and all the water contained in the cylinder is pushed out quickly making a great increase of pressure in the pipe, deflecting strongly the diaphragm of the tank T.

This shows clearly that a vibration of small amplitude of the diaphragm of T makes a great variation of amplitude of the diaphragm T₁; it is then amplified. When another stage of amplification is used, the current in the plate circuit of the second V. T. is much greater in proportion than in the first, for the current applied on the primary of the second transformer is of greater intensity. Therefore the process is reproduced in the second V. T. with a greater strength.

In the next lesson the functioning of the V. T. as an oscillator will be explained.

Questions for This Lesson

1. What is the rôle of the transformer in an amplifier?
2. What happens when an alternating current is impressed on the primary of this transformer?
3. What happens when the grid is made positive and negative?
4. Draw from memory a circuit of a one-tube audio frequency amplifier?

Dictionary of Technical Terms Used in Radio Telegraphy

Transformer—An instrument similar in action and construction to an Induction Coil inasmuch as there are two separate coils, one having few turns and the other many turns, placed close together to permit of induction and having a common laminated core. See Core Type and Shell Type, also Step-down and Step-up. Being used for Alternating Currents it does not require an automatic make and break like the Induction Coil, as the alternations produce sufficient alternations in the magnetic field to induce a current into the secondary winding.

Transient—Temporary. Passing.
Transmitting Jigger—Oscillation transformer having a variable secondary, and permitting of various degrees of coupling, by adjustment, between the two circuits.
Trembler—An interrupter for Induction Coils, resembling the hammer break but on a smaller scale.
Trigger Battery—Small battery inserted in grid circuit to give grid its initial charge when a Valve is used for transmission. Replaces Potentiometer.
Trigonometry—That branch of mathematics

dealing with computation of sides and angles of plane triangles. Is divided into right angled trigonometry and oblique angled trigonometry, according to which class of angles it is being applied to.
Trunk—A square wooden tube enclosing downleads where they have to be carried thru decks or awnings.
Tubes of Force—Another expression denoting Lines of Force.
Tudor Accumulator—The positive plate is forced by Plante process and the negative is formed by pasting.

Junior Constructor

A VARIABLE GRID LEAK

Those who never have used a grid leak that is instantly and completely variable will be surprised at the benefits of such a device. Nearly all bulbs operate best at a certain negative grid potential, and this varies greatly with different makes and types of tubes.

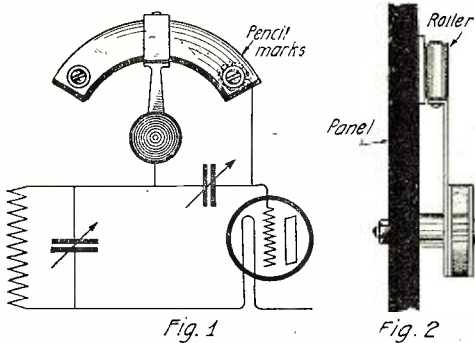

When Experimenting With Grid Leak This Type Will Be Found Useful and Besides This it Has a Good Appearance on a Panel.

Such a leak is also of the greatest benefit in controlling oscillations in a regenerative circuit.

The leak shown in the accompanying sketch has all these advantages, and is easily and quickly made. That shown in Fig. 1 is of the rotary potentiometer type, in fact, that is just what it is. The resistance sector, A, should be made of good stiff paper, and the lines, which are of varying length as shown, should be scribed on with a pencil compass, using considerable pressure. The paper should be backed with a piece of felt of the same size so as to have enough give to always meet the switch squarely.

The switch arm is simply a strip of phosphor-bronze of the proper length and should not be very stiff. The part of the blade in contact with the paper should be well rounded so as to run smoothly, and must be adjusted so that it meets the paper squarely clear across. It should be noted that if sufficient space is left at the end of the longest line the leak may be thrown out entirely by switching the blade clear to the left.

When made as described above, this leak-

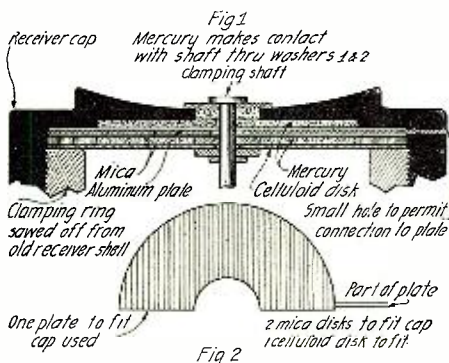

A Variable Condenser of This Type, Built in an Old Receiver Cap Saves Space and Has Great Capacity as Mica is Used for a Dielectric.

will give good service, but in time the paper sector will get smudgy and will require replacing. This may be avoided by making the switch as shown in Fig. 2. While harder to make it makes the leak quite permanent. The roller may be made of a nickled switch point. The hole in this should be filled with solder and then re-bored with a fine drill to take a brass brad which is soldered to the bent-over switch arm. Flattening the end of the brad with pliers will prevent the

roller from coming off. It will, of course, be noted that either of the leaks may be back mounted if so preferred.

Contributed by L. LONG.

A SIMPLE, RUGGED GRID OR PLATE CONDENSER.

While the construction of this condenser is not new, it makes possible the utilization of materials easily obtainable when the need is immediate. The condenser is assembled as in Fig. 1. First one of the mica discs which fits the cap is placed snugly against the small shoulder in the cap. Then the semi-circular plate lug is inserted in the small hole bored in the side of the cap and the plate pressed firmly against the mica just inserted. This plate must be flat and if it is bent in cutting should be clamped between two pieces of board before inserting. Next set in the other plate of mica and then the can rubber followed by the disc of celluloid. The end is now sawed off the receiver shell and screwed into the cap to clamp all of the elements together. A small brass washer slightly thinner than the can rubber should be placed between the celluloid disc and the second mica to make contact with the mercury in that chamber. The shaft should now be inserted and mercury introduced

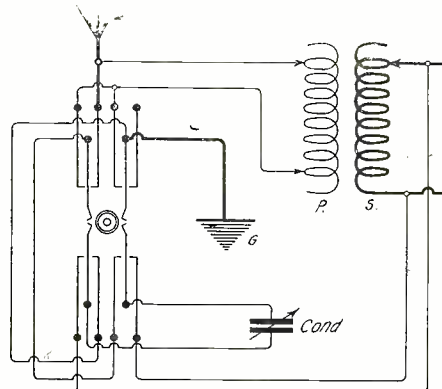

If You Own Only One Variable, Hook it Up Like This and You Can Switch it in Any Circuit.

into the chamber at the right until it will touch the clamping washer when in a vertical position. The burr is then put in place and screwed up tight. The writer found it easier to introduce the mercury in the right hand chamber thru a small hole in the celluloid which was afterwards plugged. Connections are made to the shaft and to the plate lug. If greater capacity is desired, instead of using a solid clamping shaft, a hollow one may be used and several of the units mounted on a single shaft in parallel.

Contributed by ARTHUR J. MACER.

SIMPLE HONEYCOMB COILS MOUNTING.

This type of mounting is inexpensive, convenient, and can be used with any type of coil similar to a honeycomb.

A wooden core is put in the coil the same thickness as the coil, and a half-inch hole is drilled thru it.

For a three-coil mounting, three pieces, A in illustration I, are made of some stiff non-magnetic metal, one with an angle bent on the back end for fastening to the panel. Small hinges are riveted to the other two, to furnish turning arms for primary and tickler coil. An 1/8" hole is drilled near the end of each arm. A 1/2" plug, long enough to go thru the core of the coil, is bolted by a brass bolt thru this hole, see II A. To make it possible to turn the coils without touching them the pins may be driven from the hinges, and pieces of hard-drawn copper

wire, about 5" long, put in. Turn the upper end at a right angle and solder to the arm. Turn the lower end at a right angle, and put a knob on it to swing the coil. See I B.

Six spring binding posts from old dry cells are placed at the top of the panel to make connections to the wire ends.

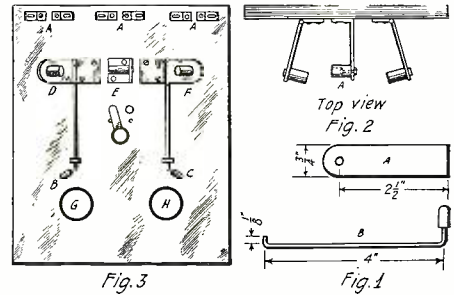

A Clever Idea for Mounting the Home Made Honeycomb Coils or Others That are Sold Without Plugs.

This mounting, altho not quite as convenient as the De Forest type plug, is much simpler and less expensive, and if the 1/2" plugs fit the coils snugly without sticking, will be found quite convenient.

Figure III is a front view of the panel. A-A-A are spring binding posts in which the wire ends of the coils are fastened. B and C are knobs for adjusting the coupling of the primary and tickler, respectively. D, E, F are the pegs on which the primary, secondary and tickler coils are placed. G and H are the primary and secondary condensers. I is a series-shunt switch for the primary condenser. In addition to the S P D T switch on the front of the panel there is another S P S T switch on the same knob bolt behind the panel.

Contributed by VICTOR ANDREW.

COMBINATION SWITCH.

Here is an original method of employing a variable condenser in three separate parts of a receiving circuit. It is accomplished by the use of a double-throw telephone switch. The condenser can be used in series or parallel with the primary circuit, or thrown over to the secondary circuit. This hook-up should meet with instant favor with anyone

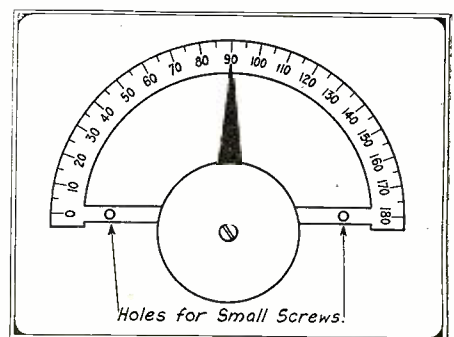

For the "Broke Bug" Who Can't Afford the Dials This Shows How to Make Nice Condenser Scales From a Protractor.

having only one variable condenser.

Contributed by WM. G. WHEAT.

A CONDENSER SCALE FROM A PROTRACTOR.

While constructing a receiving cabinet I had to use scales for the condensers. As I did not have them at hand, I made a very good substitute from a protractor which I happened to have at the time. As they are nickel-plated, they will look just as good as the scales that are bot.

Contributed by JOSEPH LEIPZIGER.

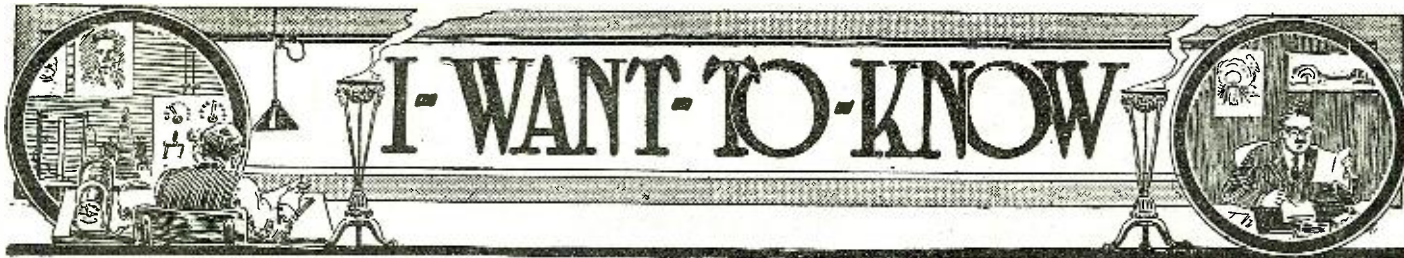

THIS Department is conducted for the benefit of our Radio Experimenter. We shall be glad to answer here questions for the benefit of all, but we can only publish such matter of sufficient interest to all.

1. This Department cannot answer more than three questions for each correspondent.
2. Only one side of the sheet should be written upon; all matter should be typewritten or else written in ink. No attention paid to penciled matter.
3. Sketches, diagrams, etc., must be on separate sheets. This Department does not answer questions by mail free of charge.
4. Our Editors will be glad to answer any letter at the rate of 25c for each question. If, however, questions entail considerable research work, intricate calculations, patent research, etc., a special charge will be made. Before we answer such questions, correspondents will be informed as to the price charge. You will do the Editor a personal favor if you make your letter as brief as possible.

ELECTRIC LIGHT LINE AS AERIAL

(140) J. Donald Moulton, Brooklyn, N. Y., asks:

Q. 1. Is it possible to use the electric light line as an aerial, and what precautions must be taken in this case?

A. 1. It is possible to use the electric light wire as an aerial by inserting a mica condenser of about 2 mfd. capacity between the line and the receiver, a ground connection being used as usual. A diagram illustrating it appears on this page.

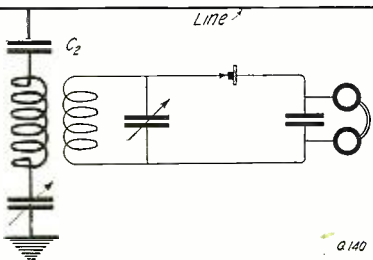

Here is How to Use a Telephone or Telegraph Line as an Aerial for Reception. The Condenser C2 is Used to Avoid the Line Being Grounded When the Tuning Condenser is Short Circuited or in Parallel With the Primary.

WIRE FOR LOOP AERIAL

(141) Anthony Greene, Detroit, Mich., wishes to know:

Q. 1. What size copper wire would be the best to use for a loop aerial?

A. 1. No. 20 copper wire is quite suitable for an aerial of this type.

Q. 2. Which is the best tickler hook-up for a loop aerial?

A. 2. A diagram of a regenerative hook-up for a loop aerial appears on this page.

1 K.W. TRANSFORMER

(142) Sidney Gleb, Tacoma, Washington, asks the following:

Q. 1. Will you kindly publish complete data for the construction of a 1-kw. closed core transformer?

A. 1. A diagram of the iron core of a 1-kw. transformer is published herewith, and the winding is made as follows:

The primary is wound with 172 turns of No. 9 D. C. C. wound in three layers. The secondary is wound in 30 pies, 1/4 of an inch thick with 938 turns in each pie. The

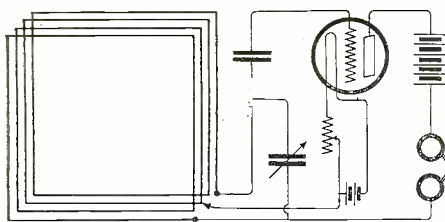

This Hook-up of a Loop Aerial and a V.T. Detector Allows the Amateur to Receive C.W. and Regenerated Spark Signals. By Turning the Loop a Directional Effect is Obtained.

length of wire required for the primary is 147 feet while for the secondary 33,710 feet of No. 30 D. C. C. are required. This type of transformer draws 11 amperes in the primary and delivers 18,000 volts.

HOO-K-UP

(143) David Murphy, Long Beach, Cal., asks for:

Q. 1. A hook-up for three honeycomb coils, audiotron, two condensers, with shunting switch for the primary condensers, and necessary switches whereby the hook-up can be changed for the reception of undamp waves.

A. 1. The hook-up for this set is published on this page.

LONG WAVE RECEPTION

(144) William L. Ames, El Paso, Texas, inquires:

Q. 1. Is it necessary to load the secondary of a short wave receiver, as well as the primary for the reception of long waves?

A. 1. Yes, the second must be loaded with an inductance in series or with a variable condenser shunted across the secondary coil.

REDUCING AERIAL WAVE LENGTH

(145) Walter O. Schwaner, Boonton, N. J., requests the following information:

Q. 1. How can I reduce the natural wavelength of my aerial which is 250 meters, for the reception of radio telephony sent on 200 meters?

A. 1. You may reduce the wave-length of your aerial by merely connecting a variable condenser in series between the primary of your coupler and the ground.

RADIO LAWS

(146) T. E. Kuehl, Gardner, Mass., wants to know:

Q. 1. Where may a code of the laws and regulations of commercial radio telegraphy be obtained?

A. 1. We suggest that you write to the Superintendent of Documents, Government Printing Office, Washington, D. C., asking for a copy of the Radio Communication Laws of the United States which is issued at the price of 15c. a copy.

AMATEUR BROADCAST

(147) Frank Ferrie, Sewanna, Nebraska, asks:

Q. 1. Where can I obtain a code chart for deciphering Navy broadcast for amateurs?

A. 1. This may be obtained from Superintendent of District Communication, Navy Department, 44 Whitehall St., New York City.

RADIATION

(148) L. Leistra, Rotterdam, Holland, wishes to know:

Q. 1. What radiation is obtained in a two-wire aerial when a current of 0.5 amperes flows in the oscillatory circuit of a spark coil transmitter?

A. 1. It is difficult to say exactly since you do not mention the voltage of the spark coil used but under favorable conditions must be about .2 or .3 amperes.

Q. 2. What type of oscillation transformer is necessary for 200 meter work?

A. 2. Any type of winding may be used but we think that pancake winding would give better results for short waves.

Q. 3. Would it be better for transmission to erect a four-wire instead of a three-

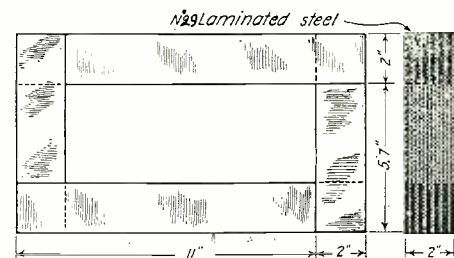

Diagram of the Iron Core for a 1 KW. Transformer. Note the Arrangement of Steel Strips Which Are Made of No. 29 Laminated Steel.

wire aerial actually in use?

A. 3. No, it is not necessary to make a new aerial. The range would not be increased by the addition of another wire.

RADIOFONE RECEIVER

(149) Lawrence F. Huber, Lancaster, N. Y., inquires:

Q. 1. Which type of receiver is the best for short wave reception, and can radio telephony be received on a regenerative circuit?

A. 1. The best type of short wave receiver actually on the market is the short wave cabinet using variometers in both the grid and plate circuits. These receivers are quite suitable for the reception of music or

(Continued on page 490)

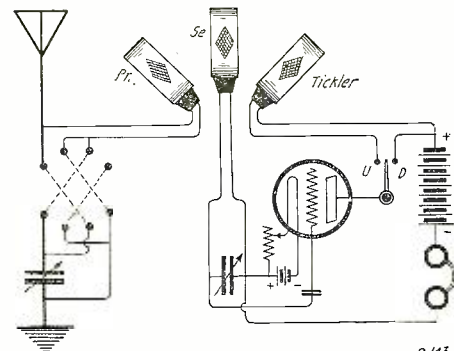

The Standard Hook-up for an Audion With 3 Honeycomb Coils. With This Set Spark Signals May Be Received as Well as Undamp Waves.

MURDOCK

No. 55

The Prices
Are Unus-
ually Low.

The Qual-
ity is Re-
markably
High.



**2000
OHM
DOUBLE SET
\$4.50**

**3000
OHM
DOUBLE SET
\$5.50**

REAL RADIO RECEIVERS

backed by a liberal trial offer and an absolute money-back guarantee. No written argument in their favor can compare with the convincing proof of their actual performance. We simply urge a TRIAL, for we know that their sensitive operation will tell more surely than verbal claims, their exceptional value. Ask your dealer for them.

BULLETIN No. 20 will be sent on request.

WM. J. MURDOCK CO.

50 CARTER STREET
CHELSEA, 50, MASS.

509 MISSION STREET

SAN FRANCISCO, CALIF.

LEARN

-at home-

You can become a Wireless Operator—you can study this fascinating and profitable profession, in your own home in your spare time. The New York Wireless Institute Course offers you an opportunity to become an operator quickly and easily. No previous experience is required—even if you have no knowledge of electricity, we can train you. Our home study course was prepared by Mr. L. R. Krumm, formerly Chief Radio Inspector, Bureau of Navigation, New York. He resigned last August to accept a position of still greater responsibility with one of the largest Radio Corporations in the United States.

You too can assure yourself of an independent position and income for life. We will teach you how. Radio experts able to impart their practical and technical knowledge to you in an easy to understand way will direct your entire course. The graded lessons with questions and answers which we send to you will prove so fascinating that you will be eager for the next one. The instruments furnished free will make it as easy for you to learn the Code, as it was to learn to talk. All you will have to do is to listen.

The Demand for Good Wireless Operators Far Exceeds the Supply

Positions are open right now and will be for some time to come for good radio operators. Activities in the Radio Industry indicate a still greater demand for trained men. The New York Wireless Institute will train you quickly so that you can take one of these positions. These positions pay good salaries and you have the opportunity to travel if you wish and see the world, and you get paid while you travel. This gives you the opportunity to save nearly every cent you earn.

TRAVEL around the world

U. S. Government Gives Credit

The Department of Commerce of the U. S. recognizing the value of the instructions given by us, allow to our graduates a five point credit, in their examination for first grade license—the maximum credit allowed to a Correspondence Institute. The United States Shipping Board will also advise you as to the value of our instruction. We have adopted the best Course in theory available; we furnish the best instruments, and issue the best text books and diagrams published.

New York

Rush Coupon to
New York Wireless Institute
Dept. 106
258 Broadway, New York

FREE INSTRUMENT

We furnish free the wonderful in the illustration given to all s One cell of c No addition The wonder Text Books, up We ple ter



The Transmitter pictured is the celebrated of the U. S. Government and by the leading U nical Schools throughout the United States a Thousands have learned telegraphy with the C and this remarkable invention will send you ones, the same as though you were receiving hundreds of miles away.

When you apply for your license the United States Gover model Omnigraph as we furnish to our students. Ask

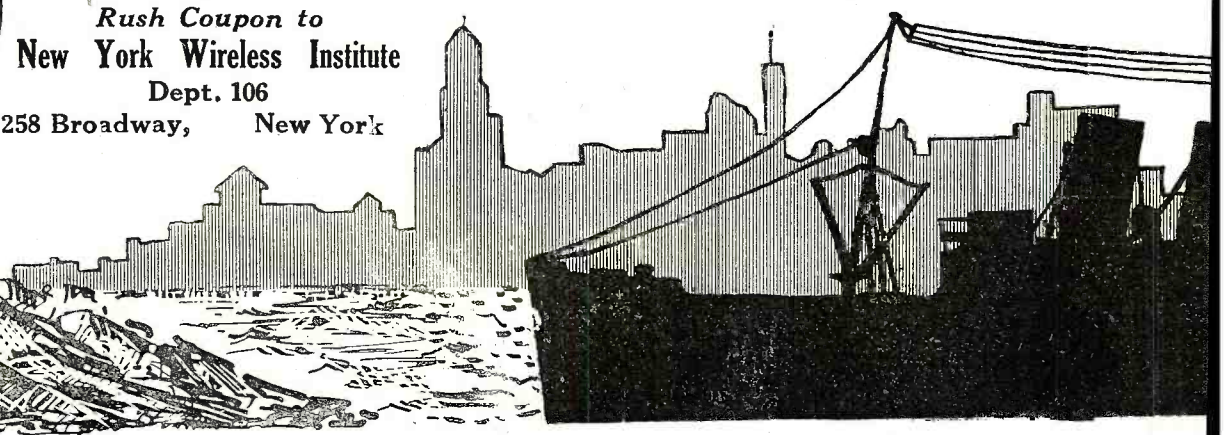
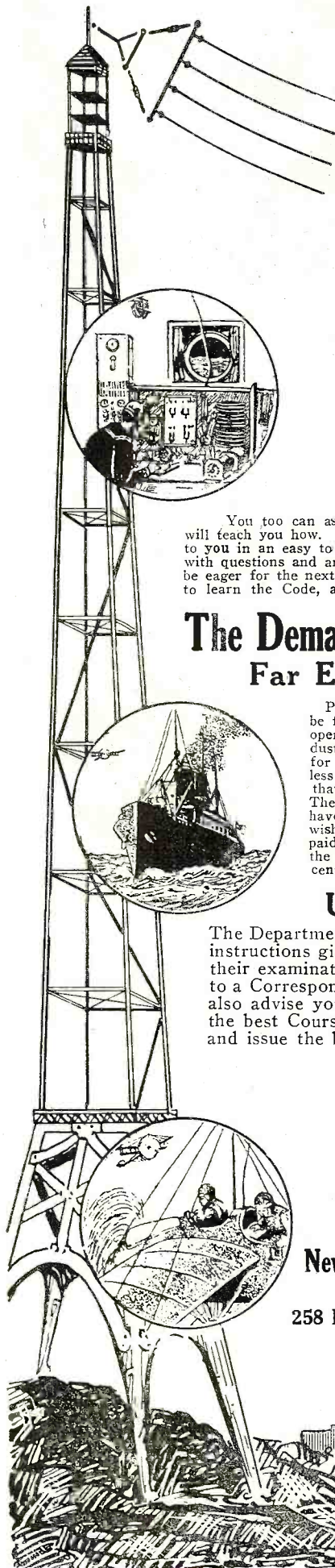

WIRELESS

-big salaries-

SETS AND TEXT BOOKS

to all students, during the Course, *receiving and sending set exactly as shown*. This set is not loaned, but **rents completing the Course**. **battery all that is required**. **wiring, aerials, etc., needed**. **Receiving and Sending Set, c., all become your property** completing the course.

so include an up to date and complete in Wireless Telephony written by our Chief Instructor, Mr. L. R. Krumm.



Omnicograph, used by several Departments in Universities, Colleges, Wireless and Technical Schools.

Omnicograph. Place the phone to your ear and receive wireless messages, thousands of different messages, through the air from a wireless station.

It will test you with the Omnicograph—the same instrument used by the United States Radio Inspector to verify this.

Wireless operators receive excellent salaries ranging from \$125 to \$200 a month and it is only a stepping stone to better positions. There is practically no limit to your earning power. Men who but yesterday were Wireless Operators are now holding positions as Radio Engineers, Radio Inspectors, Radio Salesmen at salaries up to \$5,000 a year. Any of these positions can be yours if you will let us train you and start you on the road to success.

FREE Post Graduate Course

Another feature of the New York Wireless Institute Course is that you can take a one month's Post Graduate Course, if you so desire, at one of the largest and best equipped wireless schools in New York City, absolutely free. This is not necessary to become an expert, but it would give you an opportunity

to see New York—The Wonder City—The largest port in the world, and headquarters of every leading Wireless and Steamship Company.

Easy Payment Plan

A small payment down will enroll you. We will make the payments so easy that anyone ambitious to enter the fastest growing profession—Wireless—may do so.

Send for free booklet right now before you forget; fill in the coupon at the bottom of this page and send for our free booklet "How to Become an Expert Wireless Operator." Do it now. It might mean the turning point in your entire business career.

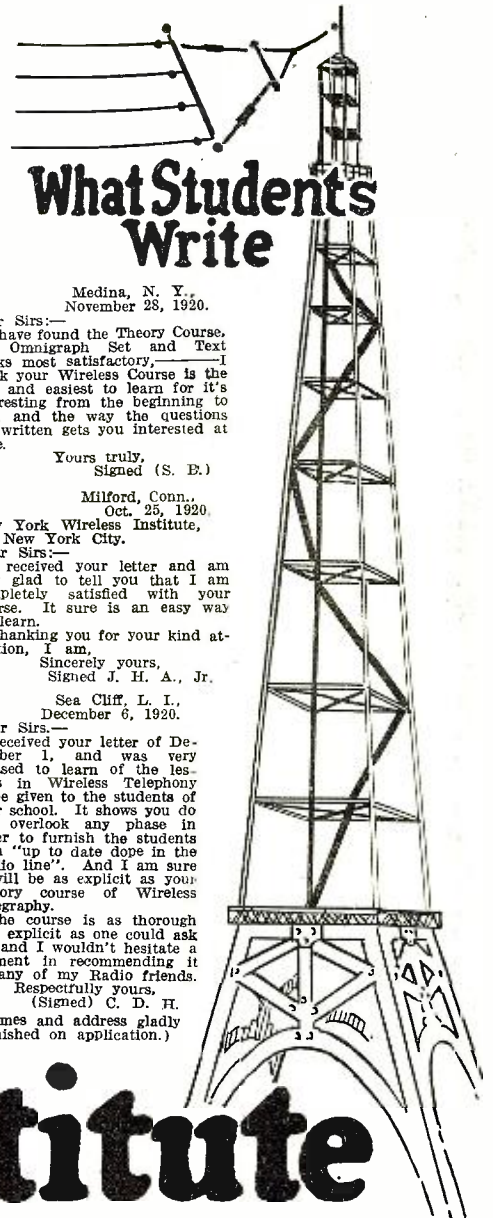

What Students Write

Medina, N. Y.,
November 28, 1920.

Dear Sirs:—
I have found the Theory Course, the Omnicograph Set and Text Books most satisfactory. I think your Wireless Course is the best and easiest to learn for it's interesting from the beginning to end, and the way the questions are written gets you interested at once.

Yours truly,
Signed (S. E.)

Milford, Conn.,
Oct. 25, 1920.

New York Wireless Institute,
New York City.

Dear Sirs:—
I received your letter and am very glad to tell you that I am completely satisfied with your course. It sure is an easy way to learn.

Thanking you for your kind attention, I am,
Sincerely yours,
Signed J. H. A., Jr.

Sea Cliff, L. I.,
December 6, 1920.

Dear Sirs:—
Received your letter of December 1, and was very pleased to learn of the lessons in Wireless Telephony to be given to the students of your school. It shows you do not overlook any phase in order to furnish the students with "up to date dope in the Radio line". And I am sure it will be as explicit as your Theory course of Wireless Telegraphy.

The course is as thorough and explicit as one could ask for and I wouldn't hesitate a moment in recommending it to any of my Radio friends.
Respectfully yours,
(Signed) C. D. H.
(Names and address gladly furnished on application.)

Wireless Institute

Rush Coupon to
New York Wireless Institute
Dept. 106
258 Broadway New York

RUSH COUPON

New York Wireless Institute,
Department 106, 258 Broadway, N. Y.
Gentlemen: Send me free of charge and without any obligation on my part your booklet "How to Become an Expert Wireless Operator." Also full particulars regarding your course, your easy payment plan, and free instrument offer.

Name

Address

City or Town

State

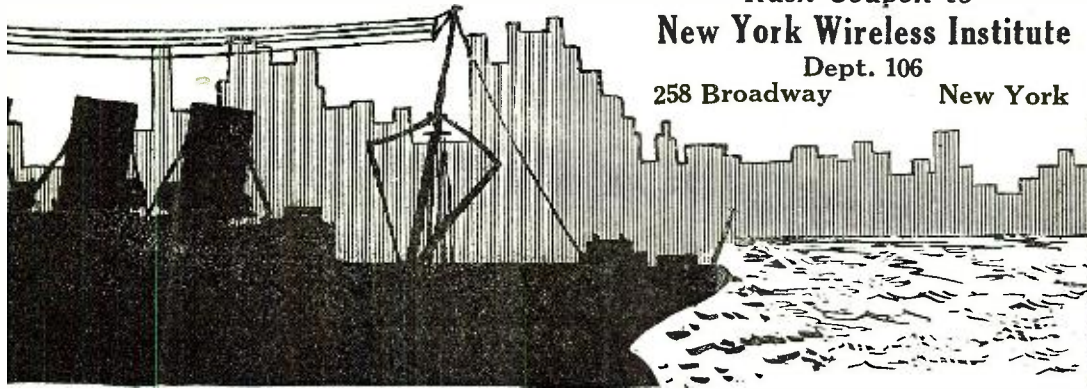

It's a Pleasure!

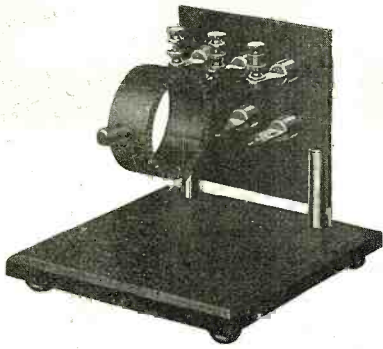

to change coils if you are equipped with a WIXICO outfit, likewise a pleasure to operate.

It's the easiest, quickest and cheapest arrangement for changing and adjusting coils as well as the most efficient.

No lost motion due to gearing. No backlash due to a multiplicity of parts and best of all no loose connections.

Operating the coil direct by means of handle on coil strap is most convenient and efficient.

Gather up your unmounted lattice coils, order a mounting, and as many plugs as required. You will have no trouble mounting coils. Full directions enclosed. State width of coils you desire to mount.

Send for descriptive circular.

Sent Parcel Post paid to any part U. S. A. on receipt of price.

- Table Type Mounting.....\$8.00
- Panel Type Mounting.....\$6.00
- Plug Complete with Handle and Strap......70

Above does not include coils. Plugs fit only WIXICO Mounting but are sold separately if desired.

Wireless Instrument Company

CINCINNATI, O. P. O. Box 669

Learn Mechanical DRAWING

EARN \$35 TO \$100 A WEEK



Are you earning less than this amount? If so my offer will interest you. I offer to give you a thorough, practical training in mechanical drawing by mail, in your spare time, at home. Course includes highest quality set of instruments and drafting equipment. I guarantee to give you a thorough, practical training that qualifies you for a high salaried position as a professional draftsman. My graduates are making good with big concerns everywhere. Write for free book of information "Your Future in Drafting". Roy C. Claffin, Pres., Columbia School of Drafting, Dept. 1324, 14th and I Sts., Washington, D. C.

TELEGRAPHY

(Both Morse and Wireless) and RAILWAY ACCOUNTING taught thoroughly and quickly. Big salaries now paid. Great opportunities for advancement. Oldest and largest school, established 46 years. Endorsed by Telegraph, Railway, Radio, and Government officials. Expenses low—opportunities to earn large portion. Catalog free.

DODGE'S INSTITUTE

D Street, Valparaiso, Ind.

How To MAKE A CHEAP RECEIVING OUTFIT.

DESIGNED BY PROF. NUT. T. WYRLOUS, B.V.D., P.D.Q.

FIRST OF ALL AN AERIAL IS NEEDED. CRAWL UP THE NEAREST TREE AND PUSH IN A FOUR INCH SPIKE TO WHICH IS SOLDERED THE "LEAD IN".

FOR A GROUND PLACE ANOTHER SPIKE IN FLOWER POT FILLED WITH MUD.

WATER DAILY!

INSULATED WIRE

OF COURSE YOU WANT AN AUDION. WELL—HERE SHE IS.

TIN STRIP

NUT & BOLT.

CARBON LAMP 1/2 C.P.

TO VARY CAPACITY, SHOVE BROOMSTICK BACK & FORTH.

HERE WE HAVE A VERY EFFICIENT VARIABLE CONDENSER.

TIN CAN

DITTO

BROOMSTICK HANDLE

CORK

CAP. 1001 M.F.

BINDING & POST

TO PULLEY TO VARY COUPLING

TO GROUND

PORTRAIT OF THE HAPPY AMATEUR USING THIS OUTFIT

AH! MARS!

BORROW THIS FROM THE TELEPHONE.

THEN—AFTER MAKING ALL THESE INSTRUMENTS, CONNECT 'EM UP WITH SOME BELL WIRE LIKE THIS

FLEMING VALVE.

P. S.

VC

BAT.

VC

P

AND THERE YOU ARE!

GREAT SPACE-SAVING IDEA. BUILD YOUR LOOSE COUPLER ON THE TABLE LEG. YOU CAN WIND YOUR LOADING COILS ON THE OTHER ONES.

SECONDARY TAPS & SWITCH

PURLOIN BATTERY FROM YOUR FORD.

HC-VBL-120

AT LAST! A REALLY CHEAP SET

Here you are, little boys; here is something for you to think about. If you were naughty during 1920 Santa Claus did not bring you that new receiving set you expected in your stockings; the next best thing for you to do is to follow out what Mr. H. Curl, of Ann Arbor, Mich., has herewith illustrated for your especial benefit.

In a letter which he wrote us he said there was *nothing to it*. The above outfit is a simple matter providing one is willing to follow out directions. In fact he is thinking seriously of entering the idea of

building a loose coupler on a table leg in the Junior Construction Department as he finds it has a particular advantage, particularly to one-armed "bugs." Don't you think it is nifty, what?

By the way, the editors of RADIO NEWS often receive cartoons from aspiring Tads and Bud Fischers, but in most instances altho the cartooning is fairly good, the ideas contained therein are *not* so good. For that reason, if any of you have ideas to illustrate, along the humorous line do not offend our editorial goat as it has poor digestion.

CLASS OF SERVICE	SYMBOL
Telegram	Bl
Day Letter	Bl
Night Message	N
Night Letter	N

WESTERN UNION

 TELEGRAM

RECEIVED AT 1407-23rd AVE, OAKLAND, CALIF.
 6SF PN 27 COLLECT NL 7 EX COPY
 MJ MATAWAN DEPOT NJ NOV 26 1920
 THE MAGNAVOX CO
 2701 EAST 14TH ST OAKLAND CALIF
 JUST RECEIVED LETTER VERIFYING ABSOLUTELY THE GENUINENESS
 OF MY RECENT RADIO PHONE TRANSMISSION TO SCOTLAND I USED
 MAGNAVOX TRANSMITTERS
 HUGH ROBINSON
 RADIO STATION 2 Q R KEYPORT N J
 1251 AM 27TH

Magnavox Special Radiophone Transmitters
will increase your Transmitting Radius

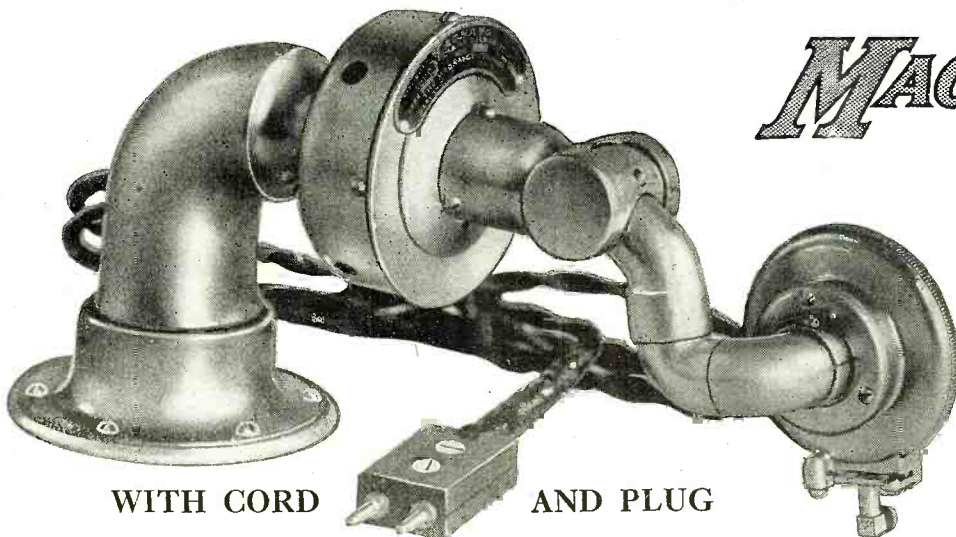

MAGNAVOX

**TRANSMITTER
TONE ARM**
 Fits Any Phonograph
 Plays All Records
 Maximum Modulation
 Perfect Reproduction
Price \$37.50

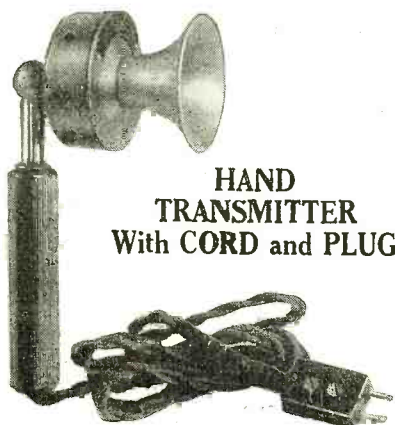

**HAND
TRANSMITTER**
 With CORD and PLUG

Price \$25.50

MAGNAVOX

SPECIAL RADIOPHONE TRANSMITTERS GIVE
 THE MAXIMUM MODULATION OF THE AN-
 TENNA CURRENT OF ANY RADIOPHONE.

Place Your Order At Once and
 You Will Receive Immediate
 Delivery of Exact Duplicates of
 2QR'S Transmitters from

THE MAGNAVOX CO., Oakland, Cal.

Personal Attention

There is a great satisfaction in trading with a concern where the members of the firm personally see that your order is filled accurately and promptly. If you are looking for such a concern, send your next order to Kelly and Phillips. Do you need any of the items listed below? Each one is one more reason for letting Kelly and Phillips fill your radio needs.

3 coil gear, mounted on oak base..	\$13.00
3 coil gear, mounted without base..	10.00
Single coil unit panel mounted.....	2.00
Double coil unit panel mounted.....	4.80
3 coil unit panel mounted.....	5.60
3 coil gear, mounted on unit panel..	10.75
Acme unmounted transformers....	4.50
Acme semi-mounted transformers....	5.00
Arco semi-mounted transformers....	5.00
Federal full mounted transformers..	7.50
Vacuum Valves	
2 Filament AudioTrons.....	6.00
Electron Relay.....	6.00
Moorhead amplifier.....	7.00

All of the above apparatus shipped anywhere in the U. S. without delay. Send your order to-day, and get personal attention from

KELLY and PHILLIPS
312 Flatbush Ave., Brooklyn, N. Y.

A Complete Portable Set

(Continued from page 445)

values of inductance providing these waves, and made of a flat spiral of cable, giving a value of 25 mhys. Taps are brot to a 4-point switch controlled from the panel front. The primary is mounted on two brass rods, and may be moved for secondary coupling by withdrawing the wave-change control. Normally the coupling is very loose.

The secondary is a flat stagger-wound inductance of 85 mhys. tapt into eight sections, or on every alternate turn which provides means for adjusting the open circuit to resonance on the different waves.

A switch is provided for shifting the antenna to receive or transmit. This is controlled from the panel front by the small control shown above the ammeter; a hot wire ammeter of 1 ampere capacity is included in the aerial circuit. Four to twelve volts may be used for the transmitter.

The normal power consumption is 12 watts, but the output will vary with different locations of the antenna system. Due to variation of the antenna constants with different locations, the apparent radiation will change considerably. The average output is 3.5 watts to .3 ampere in an antenna of 32 ohms., and .9 ampere in a loop circuit of 4 ohms. using a 300 meter wave-length. The aerial is composed of eighty-five feet of No. 16 copper wire suspended between two porcelain insulators. A counterpoise of No. 16 rubber covered wire 90 feet long is provided. The constants of this arrangement vary with each erection due to the nature of the surrounding soil, contour of the land, and height of the antenna suspension. At eight feet mean height the antenna capacity is .00015 mfd.; the inductance 40 mhys. and the fundamental wave-length 135 meters. This antenna may be shortened to 40 feet to transmit on 100 meters.

There are many engaged in radio work. There are "old timers" and those who have just begun. All are not provided with the facilities necessary to construct better equipment. It is true also, that many seeing printed material do not know where to begin, while others are far away from sources of material and supplies provided by cities. They do not have opportunity to observe workmanship of others, and consequently approach constructive problems somewhat unprepared. For this reason I shall add a few paragraphs describing briefly the parts of this equipment, and manner in which they are shaped.

PRACTICAL CONSTRUCTION

Both receiving inductances are wound on bakelite tubing 3" inside diameter and are two layer bank wound with number 26 single silk covered copper wire. The primary tube is 3 1/2" long, wound for 2 3/4" of its length and tapt at 15 points. A similar tube 3" long is wound 2 1/2" of its length for the secondary. An end margin of 1/8" is allowed on these solenoids.

Bank winding must be done by hand. A most common difficulty is the slipping of the turns while passing from one layer over to the next. A good method is to first consult an inductance curve for this type of winding to find the points at which the coil is to be tapt. Such a curve is included here. At these points a 1/8" hole is drilled after which the tube surface is covered with mucilage. After drying, the winding process may proceed. By wetting the mucilage around the tube ahead of the winding the wire will stick firmly. All under turns should be drawn tighter than those on the

(Continued on page 470)

Thirty Day Special

Audion Control Panel

Price \$6.25 Prepaid

Polished Fomica panel size 4x6 1/2 in. B battery control switch, Rheostat, tube socket, 6 binding post, and Grid Condenser, all metal parts polished nickel plated, use V. T. or Auditron bulb.

One Step Amplifier, Panel size 4x6 1/2 in. Price \$12.50 Prepaid.

Two Step Amplifier, double filament controls. Panel size 6 1/2 x 8 in. Price \$22.50 Prepaid.

Send for complete literature; it's free

Keystone Radio Company

MANUFACTURERS
Drawer 307 Greenville, Pa.

RADIO KLAUS

"The Guarantee of Satisfaction"

When you see this mark you will know that it signifies Service, Reliability—the Indelible Stamp of Superior Quality.

Our hundreds of customers and dealers know that "KLAUS RADIO" is synonymous with Square Dealing.

We take this opportunity to extend to our friends and patrons, Best Wishes for a Happy and Prosperous New Year.

KLAUS RADIO CO.
Eureka Illinois

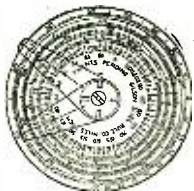

The Midget "FIVE-IN-ONE" Slide Rule is a combination Mannheim, Log-Log, Add and Subtract, Polyphase and Binary Slide Rule. It will instantly add, subtract, multiply and divide any combination involving whole numbers, fractions, decimals and mixed numbers. Gives every possible root and power of every quantity. The graduations are printed on metal coated with white celluloid and are grease and waterproof. While it is the most versatile calculator ever invented, its operation is simple and easily understood. Diameter 4".

Price with 16-page Instruction Book, \$1.50. Leatherette carrying case 50c extra. Catalog free. Your money back if you are not satisfied. Gilson Slide Rule Co., Niles, Mich.

AMATEURS

To Get Best Results Use

AECONIUM AERIAL WIRE

This is a thin flexible steel ribbon 1/4 inch wide Just the thing for your Aerial

ADVERTISING PRICE, 100 feet for 35 cents

ARLINGTON ELECTRIC CO.
133 WILLIAMS AVE. BROOKLYN, N. Y.

McLean Radio Storage Battery

Only \$19.75

Used with audion amplifier. Gives constant, dependable supply of juice for longer time than any other similar battery. One charge lasts two or three months, and any battery station will recharge for a few pennies.



Lasts 5 Years

Dry cells of equal strength which would cost \$150.00 for the same period are troublesome and unreliable; copper or sulphate batteries also are undependable.

The McLean Radio Storage Battery made especially for radio operators, is always on the job, gives no trouble. It is simple and convenient and easily transported anywhere. We offer a limited number of these splendid batteries at the low price of \$19.75. Shipped prepaid upon receipt of price—or C. O. D. if you prefer. Order now!

McLean Storage Battery Co.
721 Frankfort Street Cleveland, Ohio

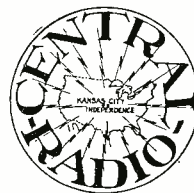

LEARN WIRELESS

at the largest radio school in the Central States. Modern complete equipment. Experienced instructors. Dormitory in connection. Students may earn expenses if necessary. Write today for catalogue and full information.

CENTRAL RADIO SCHOOL
Independence, Mo

STANDARD RADIO EQUIPMENT

MURDOCK
BRANDES
BURGESS
GREBE
BENWOOD SPEC.
DE-FORREST

AGENTS FOR
FEDERAL TEL.
AMERICAN RADIO
AUDIO TRON.
CHICAGO RADIO LAB.
DUBILIER
TRESKO AND OTHERS.

U. of I. SUPPLY STORE, Inc.
627-29-31 SOUTH WRIGHT STREET
CHAMPAIGN, ILLINOIS

SPECIAL FOR THIS MONTH

Three-inch dial and knob complete.....\$1.00
Grid leak and condenser......50
Grid or stopping condenser......35
1 1/2 inch hard rubber knobs......15
Wireless apparatus built to order. Amrad, Acme, Grebe and other makes of equipment in stock at all times.

Send five cents for catalogue.
A. C. PENFIELD, Conneautville, Penn.



This Mark Your Guarantee

This is the distinguishing symbol which protects you in buying Radisco goods. All the dealers listed below carry the Radisco line. Go to them for all your radio needs. They will gladly fill your wants with apparatus that carries this Radisco mark.

ALBANY, N. Y.
Shotton Radio Mfg. Co.
8 Market St.

ASHEVILLE, N. C.
Hi-Grade Wireless Instrument Co.

ATLANTIC CITY, N. J.
Paramount Radio Supply
518 N. Connecticut Ave.

BALTIMORE, MD.
Radio Engineering Co.
614 No. Calvert St.

BEINVILLE, QUEBEC, CAN.
Canadian Radio Mfg. Co.

BOSTON, MASS.
Atlantic Radio Co.
88 Broad St.

BROOKLYN, N. Y.
Kelly & Phillips
312 Flatbush Ave.

CHARLOTTE, N. C.
Smith Novotoy Electric

CHICAGO, ILL.
Chicago Radio Laboratories
1316 Carmen Ave.

EUREKA, ILL.
Klaus Radio Co.
Branch, Peoria, Ill.

KANSAS CITY, MO.
McCreary Radio Supply
4th and Delaware Sts.

LOS ANGELES, CALIF.
The Wireless Shop
511 W. Washington St.

NEW ORLEANS, LA.
Rose Radio Supply
604 Gravier St.

NEWARK, N. J.
A. H. Corwin & Co.
4 West Park St.

NEWCASTLE, PENN.
Pennsylvania Wireless Mfg. Co.
507 Florence Ave. "8HA"

OMAHA, NEBRASKA
O-B Radio Supply Co.
406 Brown Building

PHILADELPHIA, PENN.
Philadelphia School of Wireless
Telegraphy
Broad and Cherry Sts.

PROVIDENCE, R. I.
Rhode Island Elec. Equip. Co.
45 Washington St.

PITTSBURGH, PENN.
Radio Electric Co.
3807 Fifth Ave.

PORTLAND, ME.
Atlantic Radio Co.
15 Temple St.

SEATTLE, WASH.
Northwest Radio Service Co.
609 Fourth Ave.

SCRANTON, PENN.
Shotton Radio Mfg. Co.
P. O. Box 3
Branch, 8 Kingsbury St.
Jamestown, N. Y.

ST. LOUIS, MO.
The Benwood Co., Inc.
3424 Olive St.

TORONTO, ONT., CAN.
The Vimy Supply Co.,
567 College St.

WICHITA, KAN.
The Cosradio Co.
1725 Fairmount Ave.

To Responsible Dealers:

There are still some sections of the country that are without a Radisco dealer. If you are in such a district, you are invited to take advantage of the Radisco advertising and sales plan. Write today for particulars.

Each Radisco Instrument Represents the Most Advanced Ideas in Radio Design

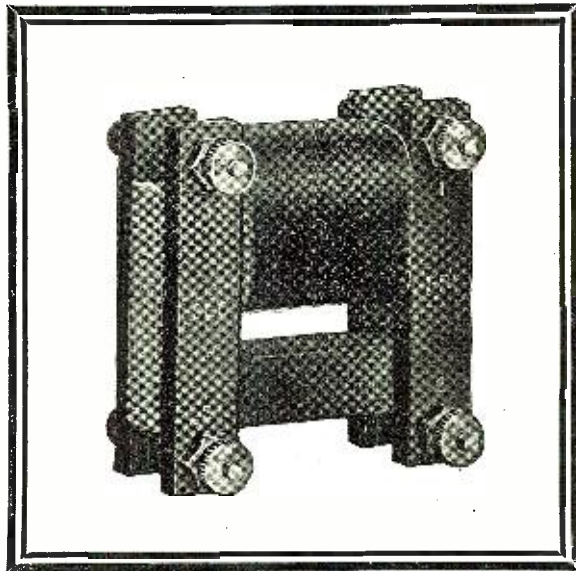

A. R. Co. Amplifying Transformer

UNUSUAL amplification and quietness of operation distinguish the radio station equipped with the A. R. Co. transformer.

A well-designed, carefully-made instrument at an amateur's price! Big production of a Standard model plus the Radisco system is all that makes it possible to offer so good an instrument at so low a price. In designing this piece of apparatus, particular reference was given to the correct ratio of impedance and turns between primary and secondary.

Another feature which makes this transformer a desirable piece of apparatus, is the simple but very effective mounting of bakelite strips, supporting the laminated closed core and coil, allowing for quick mounting in case or on panel.

No. A4 PRICE FIVE DOLLARS

Shipping weight 2 pounds

The Entire Radisco Line is Purposely Designed to Work Efficiently Together

THE success of the Radisco line is only partly due to the selection of carefully designed apparatus. Even more important is the "Radio Co-operation" of all Radisco instruments.

The amateur who installs Radisco apparatus thruout secures exceptional service from each individual instrument in his station. Besides that, he has the satisfaction of knowing that his station is a well balanced, efficient unit.

Why waste money in experiments, when you know that Radisco instruments are designed to work in combination!

RADIO DISTRIBUTING COMPANY

NEWARK, NEW JERSEY

A GOOD WORD!

223 Cowper St.,
Palo Alto, Calif.,
Oct. 12, 1920.

Coto-Coil Co.,
87 Willard Ave.,
Providence, R. I.

Gentlemen:

I received my coils several days ago, and they sure are great, regular honeycombs at almost half price. I enclose a dollar bill for which send another coil, No. 500.

Yours very truly,

Nathaniel R. Morgan

There's something about a letter from a satisfied customer, who voices his satisfaction, that makes a feller tingle all over. We're human enough to like the sensation. We hope that eventually every amateur in the country will feel "the urge" to write us such a letter. We stand ready to do our part any time—in other words, we ship by return mail.

Our standard coils are priced below—special coils quoted on request—

Turns	Price Unmounted	Turns	Price Unmounted
25	\$.50	300	\$.85
35	.50	400	.90
50	.60	500	1.00
75	.60	600	1.15
100	.65	750	1.35
150	.70	1000	1.60
200	.75	1250	2.00
250	.80	1500	2.50

Any of the above sizes will be sent prepaid to all points in the United States upon receipt of remittance. To avoid delay remit only by Postal Money Order.

COTO-COIL CO., 87 Willard Avenue
Providence, Rhode Island

A \$2.00 bill will bring you interesting reading and worth while ideas for many months to come. Bound volume No. 1 of Radio Amateur News, \$2.00 plus postage. Experimenter Publishing Co., W. J., Fulton Street, New York City.

MEMORIZE CONTINENTAL CODE IN ONE HOUR

New Method—Short cut. Thousands have done this and so can you.

Not by pounding telegraph key
Not by listening to automatic device
Master code first, then learn tools
Testimonials with street address free
Profit by experience of others.

SEND 50 CENTS

For our Short Cut Method and
SAVE 50 DOLLARS

in time in qualifying as operator.

C. K. DODGE

Box 200

Mamaroneck, N. Y.

NEW ORLEANS

RADIO

APPARATUS

and SUPPLIES

ROSE RADIO SUPPLY

604 Gravier St., New Orleans, La.

Send 10c for Latest Catalog

(Continued from page 468)

top layer. On reaching a tap, a loop about six inches long is drawn thru the hole; these loop sides may later be soldered together close to the tube, and the loop twisted in a hand drill by inserting the loop tip in the chuck. These twisted leads are rigid and tough. After winding, coils are coated twice with shellac and dried.

The primary is perpendicular to the panel back. A small brass angle brace attaches this tube to the panel back. For the secondary mount, two Formica brackets 3/4" thick are cut to form a support as shown in Fig. 6. Small 4-36 screws pass into threaded holes of the bracket base. Similar screws attach the tube ends to the curved portion of the bracket.

For the coupling condensers, two very small condensers are clamped upon a Formica strip 3/4" x 2". Each condenser is made up of two strips of copper foil 3/8" wide and 2" long separated by a sheet of 7 mil mica. A small rectangle of hard rubber 1 1/2" x 2" is clamped down over the condenser by passing 4-36 machine screws thru into the base. Terminals are threaded into the base edge and soldered to the condenser leaves. Figure 4 shows this construction. Formica is easily drilled and tapped.

TRANSMITTER

To supply the high tension two Ford spark coils are used. Both secondaries are in series by altering the primary polarity of one coil so that the free secondary ends become effective, delivering about 3/4" spark. This potential is lead directly to the spark gap and condenser. Fig. 7 shows the relative position of spark gap parts and condenser terminals.

Thirty-two sheets of 7 mil mica measuring 2" x 3" are used in each bank of the transmitting condenser. Sixteen foil surfaces 1 1/2" x 3 1/2" are each interleaved with a double thickness of mica between each two foil surfaces. Double sheets are electrically stronger than a single sheet of similar thickness. Should any defect be present in one sheet, it will be protected by the neighboring sheet. For very fine condensers, it is well to split the sheets and turn them end for end. This will not alter the thickness and makes them uniformly constant and stronger electrically. Each sheet is dipped in a mixture of equal parts of filtered rosin, bees wax, and paraffin. The condenser is stacked and a heavy hot iron placed over the group. When cool, the condenser is in block form and impervious to moisture. Projecting leaves are then collected and carefully soldered to flexible leads. Both banks are clamped between two Formica sheets 4" x 5 1/8" each. Two brackets of brass support the condenser and also serve as terminals of both condensers. Figs. 8 and 9 show this arrangement of parts.

THE SPARK GAP

The spark gap is made of two circular discs of 20 gauge phosphor-bronze cut 1 3/8" in diameter and mounted on a brass rod threaded 8-32. The center hole is 1/8" off center. This disc is mounted with knob and cylinder bushing of brass. For this spark gap, the space may be increased to 1/4" by turning the discs thru a half circle. These rotating parts are 1 3/8" between centers. Fig. 10 shows the disc pattern.

The primary of the oscillation transformer is a flat spiral of heavy lamp cord wound with nine turns which are tapped at the second, fourth, sixth and ninth turn. This spiral is clamped between two insulating discs 5 1/2" in diameter. A wooden cylinder 1 5/8" in diameter and 5/8" long is the base for the primary mounting and carries one disc on its end. A 1 5/8" opening in the second disc center allows it to slip along the wooden

(Continued on page 472)

RADIO APPARATUS

*Distributors of Reliable Radio Apparatus
to Schools, Colleges and Experimenters
All Over the World!*



"PITTS CO"

The sign of service and prompt delivery.

Why not let us prove it!

"SPECIAL"

Our New Catalog No. 22 is just out.

Insist upon your copy!

AMPLIFYING TRANSFORMERS

No. A-2 Acme, mounted.....	\$7.00
No. A-2 Acme, semi-mounted.....	5.00
No. A-2 Acme, unmounted.....	4.50
No. 226-W Federal.....	7.50

AUDION CONTROL PANELS

No. RORA Grebe, in cabinet.....	12.50
No. RORH Grebe with tickler connections.....	17.00
No. ZRD Clapp-Eastham (new type).....	12.00
No. Y-1 Acme (latest model).....	10.00
No. P-500 DeForest audion ultra-audion type with 45 V. "B" battery.....	24.00
No. P-1 Adams-Morgan "Paragon special," just out.....	6.00

"B" BATTERIES

No. 7623 Standard 23.5 V., small.....	1.50
No. 7625 Standard 22.5 V., large.....	2.65
No. 7650 Standard 22.5 V. variable.....	3.50
No. 766 Eveready 22.5 V., large.....	3.50
No. 763 Eveready 22.5 V., small.....	2.25
No. 703 Eveready flashlight cells, set of 10, 45 V.....	3.50

BOOKS

Practical Wireless. By Bucher.....	2.25
Experimenter's Manual. By Bucher.....	2.25
Vacuum Tubes. By Bucher.....	2.25
How to Pass U. S. Exams. By Bucher.....	.75
How to Conduct Radio Club. By Bucher.....	.75
Practical Wireless Stations. By Bucher.....	.75
Radio Telephony. By Goldsmith.....	2.50
Radio Inst. and Measurements.....	1.75
Elem. Princ. of Wireless. By Bangay: Part 1.....	1.75
Part 2.....	1.75
Both for.....	3.25
Robinson's Manual of Wireless Tel.....	2.50
Consolidated Call-Book (new edition when issued).....	1.50

C. W. INDUCTANCES

No. 181 Tuska C. W. Inductance.....	7.50
No. 181 Tuska C. W. Inductance, unassembled.....	5.00
No. 182 Tuska C. W. Inductance.....	10.00
No. 182 Tuska C. W. Inductance, unassembled.....	7.50
No. 183 Tuska C. W. Inductance.....	12.50
No. 183 Tuska C. W. Inductance, unassembled.....	10.00

CHOKO COILS

Acme 1 1/2 Henry, 500 MA Single coil.....	6.00
Acme 1 1/2 Henry, 500 MA Double coil.....	8.00
Acme 1 1/2 Henry, 150 MA Single coil.....	4.00
Acme 1 1/2 Henry, 150 MA Double coil.....	6.00

TELEPHONE TRANSMITTERS

No. 323-W W. E. Transmitter only.....	4.00
No. 5175-A Conn. Transmitter only.....	3.90
No. 5176-A Conn. Transmitter with extension arm.....	4.25

RESISTANCES (Ward Leonard)

Ward Leonard Resistance, 5000 ohm.....	\$16.70
Ward Leonard Resistance 10000 ohm.....	2.95

MODULATION TRANSFORMERS

Acme A-3 unmounted.....	7.00
Acme A-3 semi-mounted.....	5.00
Acme A-3 unmounted.....	4.50

GRID LEAKS

No. MW-1 Marconi 1, 2, 3 or 5 megohms.....	1.25
No. C-21 Chelsea Variable 1/2 to 5 megohms, 10 values.....	3.00
No. C-22 Chelsea Oscillator, makes any circuit oscillate.....	3.00

LOOSE COUPLERS

No. A-1 Arnold 3500 meters.....	22.00
No. Y-673 Clapp-Eastham 3000 meters.....	14.00
No. 344 Murdock 1500 meters.....	9.00
No. RKAB Grebe Variometer-coupler, 1000 meters, in cabinet.....	25.00

METERS (Weston Model 301)

Model 301 0-3 amperes flush.....	8.50
Model 301 0-5 amperes flush.....	8.50
Model 301 0-50 Volts flush.....	8.50
Model 301 0-100 Mill-ampere flush.....	8.50
Model 301 0-300 Mill-ampere flush.....	8.50
Model 301 0-500 Mill-ampere flush.....	8.50
Model 301 0-800 Mill-ampere flush.....	8.50

METERS (Hot Wire)

No. 127 Gen. Radio flush 0-1 Amp.....	7.75
No. 127 Gen. Radio flush 0-3 Amp.....	7.75
No. 127 Gen. Radio flush 0-10 Amp.....	7.75
No. 127 Gen. Radio flush 0-5 Amp.....	7.75

TRANSFORMERS (Acme, new type)

Acme 250 Watt, mounted.....	16.00
Acme 250 Watt, unmounted.....	13.00
Acme 500 Watt, mounted.....	22.00
Acme 500 Watt, unmounted.....	18.00
Acme 1000 Watt, mounted.....	33.00
Acme 1000 Watt, unmounted.....	28.00

TRANSFORMERS (For CW Work)

Acme 200 Watt, mounted.....	20.00
Acme 200 Watt, unmounted.....	16.00
Acme 50 Watt, mounted.....	15.00
Acme 50 Watt, unmounted.....	12.00

ROTARY GAPS

No. 443 Murdock 4000 R.P.M.....	18.50
No. 124 Klitzgen (latest type).....	26.00
Benwood (Noiseless).....	30.00
Benwood rotors, 8, 10 or 14 point.....	8.00
Hyrad rotors.....	10.50
Thorderson rotors.....	6.00
Murdock rotors, 3/16 or 1/4 inch shafts.....	3.00

QUENCH GAPS

Amrad 1 KW. Type.....	\$41.50
Amrad 1/2 KW. Type.....	24.50
Amrad 1/4 KW. Type.....	12.00

REGENERATIVE RECEIVERS

No. CR-1 Grebe, 170-600 meters, tube-control self-contained. Complete set.....	90.00
No. CR-2 Grebe 170-600 meters.....	51.00
No. CR-3 Grebe "Relay Special" 170-600 meters.....	65.00
No. CR-3A Grebe 170-375 meters, the latest Grebe short wave receiver.....	45.50
No. CR-3A Grebe 170-375 meters.....	65.00
No. CR-6 Grebe 170-600 meters, detector and two step amplifier self contained. A complete set. Ideal for Wireless phone reception. A masterpiece.....	200.00
No. CR-7 Grebe 500-2000 meters. "Long wave special." A complete set. Ideal for long waves. A wonderful set.....	210.00

RHEOSTATS

No. 214 Gen. Radio Back mtg.....	2.50
No. F-2 Paragon Back mtg.....	1.75
No. R-1 Remler Back mtg.....	1.75
No. F-200 DeForest Porcelain.....	1.00

TELEPHONES

No. 55 Murdocks 2000 ohms.....	4.50
No. 55 Murdocks 3000 ohms.....	5.50
Brandes "Superior" 2000 ohms.....	5.00
Brandes "Trans-atlantic" 2800 ohms.....	12.00
Brandes "Navy Type" 3200 ohms.....	14.00
Baldwins, Type C, Navy Standard.....	16.50
Baldwins, Type E, Super-sensitive.....	20.00
Century 2200 ohms Govt. standard.....	12.50
Century 3200 ohms Govt. standard.....	14.00
Brown 4000 ohm Imported, super-sensitive, double armature.....	20.00

VACUUM TUBES

Radiotron U. V. 200 Detector Tube, just out.....	5.00
Radiotron U. V. 201 Amplifying Tube, just out.....	6.50
No. M-1 Electron Relay.....	6.00
No. M-2 Moorhead Amplifier.....	7.00
No. M-3 Moorhead extra hard Trans.....	7.50
No. A-1 Audiotron.....	6.00

VACUUM TUBE SOCKETS

No. R-300 DeForest.....	1.50
No. MW-1 Marconi.....	1.50
No. 55 Murdock.....	1.00
No. 150 Gen. Radio.....	1.75
No. R-400 Inverted type.....	2.40

Important! Our new catalogue No. 22 illustrating, describing and pricing our immense stock of radio apparatus sent upon receipt of 10 cents. Insist upon receiving your copy! Pittsco service reaches all over the world! Why not let it reach you!

F. D. PITTS CO., Inc.

12 Park Square

Dept. C

Boston, Mass., U. S. A.

Cable address "PITTS CO" Boston

The New RADIOTRON

Radiotron U. V. 200

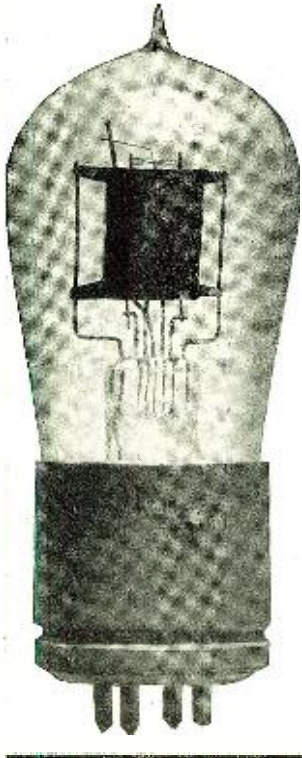

This new Detector and Amplifier Tube is the latest product of the Research Laboratories of the General Electric Company. It has been especially designed to meet the requirements of the Amateur and experimental field, viz: the production of a tube which would prove a sensitive detector and a superior amplifier, and which could be operated off a single standard 22½ volt plate battery.

RADIOTRON U. V. 200 is the best radio detector and audio frequency amplifier yet produced. It is particularly adapted to Standard regenerative circuits in which it functions with greater sensitiveness and stability than any other tube.

Best detector action is provided by a grid condenser of 0.00025 MFD. capacity, and the Radio Corporation's Standard Grid leak of ½ megohm resistance. The plate voltage must be closely adjustable from 18 to 22½ volts. The requisite variation of the plate voltage may be obtained in three ways:

- (1) By a standard "B" battery potentiometer;
- (2) By a "B" battery with taps to each cell;
- (3) By a special "A" or Filament Battery Potentiometer of 200 ohms which will be manufactured by the Radio Corporation. In the case of the last mentioned method the negative terminal of the "B" battery (which is tapped from the 12th cell) connects to the variable contact on the "A" Battery Potentiometer.

When used as an Audio frequency Amplifier, RADIOTRON U. V. 200 can be worked from a standard "B" Battery without provision for variation of the plate voltage.

This tube is destined to be the "Best Seller" yet placed on the market. Place your order early.

Radiotron U. V. 201

This Tube is also a newly designed detector and amplifier of the Plotron type, which was developed in the General Electric Company's Research Laboratory. Experts who have tested this tube pronounce it to be the most efficient and stable Amplifier available to date. The normal plate voltage is 40 (2 standard "B" Batteries), but plate E. M. F.'s up to 100 volts may be used with increasing amplification.

All Radiotrons are manufactured in accordance with rigid specifications, assuring a uniform product. They are made to fit standard four-prong sockets.

Watch future announcements for data concerning the other types of Tubes and devices which will be soon placed on the market.

PRICES:

NO. U. V. 200 RADIOTRON (Gas content detector and amplifier)\$5.00

No. U. V. 201 RADIOTRON (Plotron detector and amplifier)\$6.50

(Include Postage on one pound parcel post.)

ATLANTIC RADIO COMPANY

INCORPORATED

88 Broad St.
BOSTON, MASS.

Branch 15 Temple St.
PORTLAND, MAINE

GALENA :- SILICON

Galena Crystal Mounted in Fusible Metal Button	- -	Postpaid \$5.50
Silicon Crystal Mounted in Fusible Metal Button	- -	.. .50
Galena Crystal Unmounted	- - - -	.. .25
Silicon Crystal Unmounted	- - - -	.. .25

Every Crystal Guaranteed and Backed By My Nine Years Experience Supplying the U. S. Navy

R. BROWNLIE, 27 Oakland Ave., EVERETT, MASS.

MARKO BATTERIES

4 V. 40 A. H. ...List \$10.75...Our Price, \$10.00
6 V. 60 A. H. ...List \$20.00...Our Price, \$18.50

PARKIN VARIABLE CONDENSERS

Unit only, \$1.50. With knob, scale, etc. .. \$2.00

CARDBOARD TUBING

3½" and 4" diameters at, per foot 25c

XX BAKELITE PANELS

7/32" thick, 12" wide, per inch in length... \$30
Short wave set panels, 8" x 18" x 3/16" at... \$3.75

"G.A." FIXED CONDENSERS

Grid. 35c. Gridleak-Condenser, 50c. Phone 35c

Postage extra on all orders.
Circulars for stamp.

A. K. LAING, RADIO SUPPLIES, Pelham Manor, N. Y.

(Continued from page 470)

core; the spiral windings are clamped by attaching the disc rims with small machine screws. This later disc with openings for the taps is shown in Fig. 11. The wave-change switch controlled by a rod extending to the panel front is directly mounted upon the free end of the wooden core as shown in the illustrations. The primary system slides along two brass rods which are further used to clamp the secondary to the panel. Small phonograph records ground smooth are used as supports for the primary coil.

The secondary is stagger-wound thru seven wooden pegs set radially about one end of a cylinder of wood 1½" diameter and 2½" long. Thirty turns of No. 18 annunciator wire are wound and tapt at eight points. The coil diameter is six inches. The pegs are ⅜" wooden "meat-skivers." Cylinders are cores of magnet wire spools. After tapping, the leads are soldered to the eight point secondary variation switch. The coil is then heavily varnished with shellac.

A very small aerial switch is built upon a Formica block cut as shown in Fig. 17. Three contact points are provided with the outer two connected to receiver and transmitter thru counter-sunk wires soldered beneath the contact shank. A two blade phosphor-bronze contact lever is clamped between a brass cylinder and nut on a ⅜" brass rod. A flexible spiral lead connects this arm to the antenna bushing terminal. In forming switch arms or springs of phosphor-bronze, the portion to be bent is heated to a bluish color and then plunged into water. It may then be readily bent and afterward polished. This material will crack and split if it is not done.

The detector shown in the illustrations and Fig. 13 is mounted on a strip of Formica 3" long x ⅝" wide. Two slotted brass strips at either end make contact and support the detector from two binding posts on the panel front. A bent clip at either end supports a crystal mounting and contact adjuster carried on a ⅛" rod. A small knob and contact clamp are mounted on this rod. It passes thru a 3/32" piece of rod inserted between blades of one clip. A pivot and moving friction point are provided.

A stopping condenser of .002 mfd. made of mica and tin foil shunt the telephone receivers and is mounted similarly to the coupling condenser.

THE PANEL

All contacts should be soldered and the wiring which is made of rigid copper wire should be encased in varnished cotton sleeving.

In building small instruments it is imperative that every point, hole, or screw position must be accurately placed. Once the panel is cut and bored it must not be altered; any change should be elsewhere. In drilling holes in bakelite or Formica, the point should first be struck with a sharp prick punch and drilled with a 1/16" hole that may later be enlarged or counter-sunk to receive any rod, threaded work or screws. Unless this precaution is taken different densities may force the drills aside, thus jamming the parts mounted there.

It is best to make a panel drawing to scale showing all the component parts and positions they occupy. Every hole and opening, scale engraving, numeral positions, and all panel work should be accurately placed. This print should be placed over the panel and all hole and switch centers should be struck thru the print with a fine prick-punch. Square openings should be struck at the corners and these points later connected by guide lines and cut out with a scroll saw. This material is easily worked in this manner.

(Continued on page 474)

The Third Edition of the Consolidated Radio Call Book

Very Greatly Enlarged—Will Be Ready January 20th

192 pages. (32 pages more than 2nd edition,) better paper, stiff covers etc.

Some of the special information contained in the new book: Radio rate sheet (charges to and from vessels, etc.); Cable rates; Table for finding cable charges to various points; Weather reports and hydrographic reports of the world; Time signal section of the world; American radio compass stations; French radio compass stations; British radio compass stations; Canadian radio compass stations; General information section; International abbreviations; High power radio stations of the world; Press schedules of spark stations.

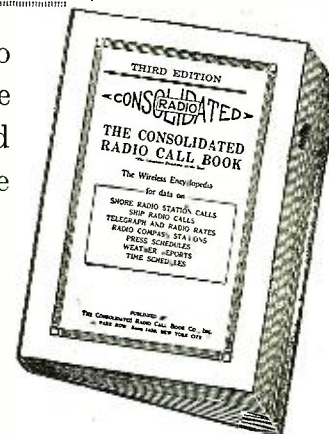

The Consolidated Radio Call Book is the only book in print officially listing all the Radio calls as issued by the Bureau of Commerce. Every vessel and land station in the world is represented and listed alphabetically, according to names of vessels or land stations, and according to call letters; Revision of American coastal stations under U. S. Naval control, and their new calls.

Every New Amateur Call Is Listed

SPECIAL—Given Free with Each Copy

A Wireless Map of the World in colors is given absolutely free with each copy. This map shows the locations of all the high powered RADIO stations in the world, including the time signal stations. In addition it tells at a glance how far away any of these stations are. Of greater interest are the time zones, which enable the amateur to compute instantly the correct time for the zone in which he is located from any time signal station.

The second edition of 10,000 copies was exhausted in ten days. The book is on press now and will positively be ready on January 5th. Order direct or reserve your order from your favorite dealer

Price \$1.50 Prepaid

Either Direct from us or for sale by the following responsible Dealers:

- | | | | |
|---------------------------------------|---------------------|---------------------------------------|----------------------|
| American Electro Tech. Appliance Co., | New York City | Paramount Radio Supply Co., | Atlantic City, N. J. |
| American Hardware Stores, | Bridgeport, Conn. | Parks, Henry Francis, | Butte, Mont. |
| Atlantic Radio Supply Co., | Boston, Mass. | Pearlman's Book Shop, | Washington, D. C. |
| Bamberger & Co., L., | Newark, N. J. | Pennsylvania Marconi Wireless School, | Philadelphia, Pa. |
| Beuwood Specialty Co., | St. Louis, Mo. | Piedmont Electric Co., | Asheville, N. C. |
| Brode Electric Co., | Los Angeles, Cal. | Pioneer Electric Co., | St. Paul, Minn. |
| Bunnell & Co., J. H., | New York City | Pitts Co., F. D., | Boston, Mass. |
| California Electric Co., | San Francisco, Cal. | Post Office News Co., | Chicago, Ill. |
| Catton, Neill & Co., | Honolulu, T. H. | Precision Equipment Co., | Cincinnati, Ohio |
| Chicago Radio Apparatus Co., | Chicago, Ill. | Radio Distributing Co., | Newark, N. J. |
| Cutting & Washington Radio Corp. | New York City | Radio Electric Co., | Pittsburgh, Pa. |
| Dewey Sporting Goods Co., | Milwaukee, Wis. | Radio Equipment Co., | Boston, Mass. |
| Doubleday-Hill Electric Co., | Pittsburgh, Pa. | Radioelectric Shop, | Cleveland, Ohio |
| Electro Importing Co., | New York City | Reuter Electric Co., | Cincinnati, Ohio |
| Findley Electric Co., | Minneapolis, Minn. | Riverside Laboratory, | Milwaukee, Wis. |
| Fuller Co., Seth W., | Boston, Mass. | Saunders Co., Geo. S., | Boston, Mass. |
| Holt Electric Utilities Co., | Jacksonville, Fla. | Schmidt & Co., Rudolph | Rochester, N. Y. |
| Hovey, A. T., | Boston, Mass. | Shaffers', | Norfolk, Va. |
| Jenkins, Lester J., | New Bedford, Mass. | Shotton Radio Mfg. Co., | Scranton, Pa. |
| Katzenbach & Co., F. S., | Trenton, N. J. | Smith Novotoy Electric, Inc., | Charlotte, N. C. |
| Kluge, Arno A., | Los Angeles, Cal. | Southern Electrical Supply Co., | San Diego, Cal. |
| Krause & Co., A. F., | Detroit, Mich. | United Radio Telegraphers' Assoc., | Baltimore, Md. |
| Manhattan Electric Supply Co., | New York, Chicago | Western Radio Electric Co., | Los Angeles, Cal. |
| McCarthy Bros. & Ford, | Buffalo, N. Y. | Whitall Electric Co., | Westerley, R. I. |
| McClurg & Co., A. C., | Chicago, Ill. | White & Boyer Co., | Washington, D. C. |
| Meter Electrical Construction Co., | Oshkosh, Wis. | Williamson Electric Co., H. E., | Seattle, Wash. |
| Meyberg Co., Leo J., | San Francisco, Cal. | Wireless Mfg. Co., | Canton, Ohio |
| Mohawk Electrical Supply Co., | Syracuse, N. Y. | Wireless Press, | New York City |
| New Era Shop, | Milwaukee, Wis. | Wireless Shop, | Los Angeles, Cal. |
| Newman-Stern Co., | Cleveland, Ohio | Young & McCombs, | Rock Island, Ill. |
| Nola Radio Co., | New Orleans, La. | Young Men's Christian Assoc., | Los Angeles, Cal. |
| Noll & Co., E. P., | Philadelphia, Pa. | Zamoiski Co., Jos. M., | Baltimore, Md. |
| N. S. W. Bookstall Co., | Sydney, Australia | | |

Published by

Consolidated Radio Call Book Co., Inc.

41 Park Row, New York City



899 Boylston St.
Boston, - Mass.

TEL.
BACK BAY
5 9 6 4

DO YOU KNOW ???

That the EASTERN RADIO INSTITUTE offers more undeniable advantages to those interested in studying Commercial Radio than any other school in New England, if not in the country?

DO YOU KNOW that the EASTERN RADIO INSTITUTE is the **OLDEST, LARGEST** and **BEST EQUIPPED** radio and telegraph school in New England?

To make this unmistakably clear we can give the following facts:

The EASTERN RADIO INSTITUTE was founded in 1913 and is now **OVER SIX YEARS OLDER** than **ANY OTHER** Radio and Telegraph school in New England! All schools starting before us are **NO LONGER IN EXISTENCE!** **WE ARE THE PIONEER SCHOOL.**

The EASTERN RADIO INSTITUTE actually has **HUNDREDS** of earnest and intelligent students now in attendance. We have given instruction at this date to over **4,000** different students and have actually enrolled, graduated and placed more Commercial operators than **ALL OTHER SCHOOLS IN NEW ENGLAND COMBINED!**

The EASTERN RADIO INSTITUTE is equipped with **THOUSANDS** and **THOUSANDS** of dollars worth of splendid panel spark sets, Federal Arc apparatus, panel receiving sets, storage battery equipment, etc.

DO YOU KNOW that the EASTERN RADIO INSTITUTE has **ALWAYS** placed every graduate in a good position, kept them employed and can actually **GUARANTEE** these positions?

DO YOU KNOW that our graduates may be found all over the world as Chief Operators, Teachers in other Radio Schools, Chief Radio Inspectors, Engineers, Directors of Corporations, Superintendents etc?

DO YOU KNOW that we are the **ONLY** school in New England giving instruction upon actual Federal arc apparatus?

DO YOU KNOW that our systematically planned and thoroughly executed course of practical instruction positively brings **RESULTS**—Your Commercial first grade license.

Certainly these advantages must be apparent to you. Besides it costs no more to take our course, thus availing yourself of our **YEARS** of **RESULTS** and **SUCCESS**. **SUCCESSFUL** graduates of the EASTERN RADIO INSTITUTE are found all over the world! Why not be one?

DAY AND EVENING CLASSES. START ANY MONDAY

Our latest, illustrated prospectus is free. If you cannot visit the Institute send for one. If there is any further information or assistance our organization can give you please command me!

Sincerely yours, F. D. PITTS, Director

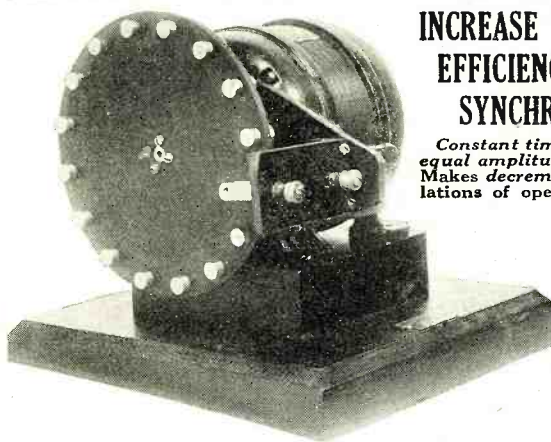

INCREASE YOUR TRANSMITTING EFFICIENCY. Use a Ray-Di-Co SYNCHRONOUS SPARK GAP.

Constant time interval between discharges of equal amplitude. Clear clean cut spark tone. Makes decrement extremely low. Keeps oscillations of open

circuit out of closed circuit. Puts the current where it belongs, in the antenna. Motor follows every voltage variation obtaining the maximum condenser discharge. Total length of conductors in gap less than 3" permitting the use of a larger condenser. Adjustable stationary electrodes, large discharge surfaces, Bakelite-Dilecto Grade XX used throughout. Quiet running.

Motor of single phase SYNCHRONOUS type, 1/6 H. P. 110 volt, 60 cycle. Net wt. 35 lbs. F. O. B. CHICAGO \$85.00.

RAY-DI-CO.

2653-A N. Clark St., Chicago

Specializing in the designing and construction of Radio Phones to your specifications.

A welcome addition to your library! Send \$2.00 plus postage today and your copy of bound volume No. 1 of Radio Amateur News will come forward by return mail. Experimenter Publishing Company 236a Fulton Street, New York City

(Continued from page 472)

For white in-lay scales, the ends of each line are indicated by the prick-punch thru the print. These points are connected by cutting a straight line from one to the other. A small file's tip flatly sharpened will cut these lines below the panel surface. White lead is then rubbed into and across these depressions. Afterward, they are brushed with a dry cloth for removing superfluous material. For a circular line in scale making, very sharp steel dividers are used in scratching deeply a curved line after which the radius is decreased slightly to give the line its width. By repeated scratching over this course, a deep line is soon cut that may then be filled with white lead.

One not familiar with letter stamping had best practice upon a scrap of material. Bakelite works much better than Formica. In the latter the base is quite soft, but has a very hard and brittle polish surface. In stamping letters or numerals, too severe a blow will crush this surface badly. The drawing or print referred to should be used by tapping the letter lightly. It will then show its position on the paper and if this is satisfactory, it may be struck **once quite heavily**. Experience only will teach how this may be done. Some letters such as Figure 1 stamp easily, while others like Figure 4 invariably require caution. For hand stamping, "x" letters are best suited. This should not be attempted on one's first work. The tendency is to over-do it.

In building equipment, patience is as necessary as the material itself. It has been said that carefully made equipment never is as satisfactory as that which is thrown together. But I have observed that a little caution in this throwing process has not seriously effected any work.

Audio or Radio Frequency Amplifier?

(Continued from page 441)

voltage amplification obtained. This condition is termed "tuned amplification" and is a great advantage, since not only is maximum voltage amplification obtained but it also serves to eliminate interfering signals of slightly different frequencies. This effect is greatest when receiving very weak signals.

When employing a single vacuum valve as a detector the incoming energy is often so small that after being transferred to the telephone receivers no sound or only a very weak one may be heard, as the current is not of sufficient strength to operate them properly. If rectification has taken place at all, the audio frequent current in the plate circuit of the detector may be amplified sufficiently to render reliable reception under these conditions. The transformer coupled amplifier is usually employed and the connections are shown in Fig. 5.

The initial function of this circuit is to produce rectification and this is accomplished as illustrated in the accompanying groups, Fig. 3. The resultant pulsations caused by variation of the plate current at audio frequency flow thru the primary of the transformer M and are impressed upon the grid of the amplifier V₂. They are then amplified, and the current flowing thru the fones is an amplified reproduction of the current at audio frequency flowing in the plate circuit of the first tube.

Transformers employed for audio frequency amplification are constructed with finely laminated iron cores and those used for radio frequency amplification have only air cores, to avoid serious losses due to hysteresis.

(Continued on page 476)

Chemical Laboratory

\$6⁷⁵

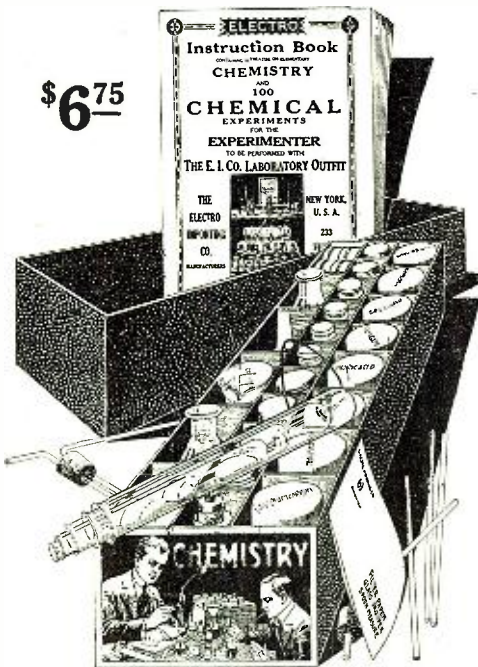

No. 4889

We present herewith to our friends our E. I. Co. Chemical Laboratory which contains real chemicals and apparatus to perform real chemical experiments. This outfit is not a toy, put up merely to amuse, but a practical laboratory set, with all the chemicals, apparatus and reagents necessary to perform real work and to teach the beginner all the secrets of inorganic chemistry. With this outfit we give free a book containing a Treatise in Elementary Chemistry, useful data and recipes, and 100 instructive and amusing experiments.

DESCRIPTION OF THE OUTFIT:

The outfit consists of forty-four (44) Chemicals all C. P. (chemical pure) put up in appropriate wooden boxes, glass bottles and hermetically closed jars. The acids are put up in glass bottles, with ground-in glass stoppers and there is a sufficient quantity of chemicals supplied (mostly one to two ounces) enough to make dozens of experiments with each.

The apparatus furnished are all of the best obtainable make and of standard laboratory size and shape. 17 pieces of apparatus furnished with this outfit.

The instruction book is a real Chemistry Course for the Beginner. Some of the Contents are: Division of Matter: This is a Treatise on Elementary Chemistry and deals with the theory of the Elements, Molecules and Atoms, etc. Chemical Nomenclature: This explains in simple language the derivation of the chemical names of the Elements and their compounds. There is a chapter on Laboratory Operations; Glass Working; First Aid; Fire Extinguishers; Experimenters' Aphorisms, etc.

A good part of the book is devoted to Weights and Measures. The Metric System, the English System and the U. S. System are fully explained.

The following tables are furnished: Symbols and Atomic weights of the Elements; Measures of Weights, Volume, Capacity and Length; Per Cent solutions; Conversion of Measure expressed in parts; Poisons and their antidotes; Technical and common name of chemical substances; Formulas for Cleaning various substances, etc., etc.

Among the 100 Experiments are:

How to make chemical tricks; How to make invisible and magic inks; How to test flour; How to test soil; How to Make Chlorine Gas and Smoke (German War Gas); How to bleach cloth and flowers; How to produce Oxygen and Hydrogen; How to make Chemical Colors; How to test Acids and Alkalies and hundreds of interesting hints and formulas.

Price \$6.75. Shipping Weight 10 lbs. (Can be shipped by Express only.) Immediate Shipment

The Boy's Electric Toys

THE BOY'S ELECTRIC TOYS" contains enough material TO MAKE AND COMPLETE OVER TWENTY-FIVE DIFFERENT ELECTRICAL APPARATUS without any other tools, except a screw-driver furnished with the outfit. The box contains the following complete instruments and apparatus which are already assembled:

Student's chromic plunger battery; compass-galvanometer, solenoid, telephone receiver, electric lamp. Enough various parts, wire, etc., are furnished to make the following apparatus:

Electromagnet, electric cannon, magnetic pictures, dancing spiral, electric hammer, galvanometer, voltmeter, hook for telephone receiver, condenser, sensitive microphone, short distance wireless telephone, test storage battery, shocking coil, complete telegraph set, electric riveting machine, electric buzzer, dancing fishes, singing telephone, mysterious dancing man, electric jumping jack, magnetic geometric figures, rheostat, erratic pendulum, electric butterfly, thermo electric motor, visual telegraph, etc., etc.

This does not by any means exhaust the list, but a great many more apparatus can be built actually and effectually.

With the instruction book which we furnish, one hundred experiments that can be made with this outfit are listed, nearly all of these being illustrated with superb illustrations. No other materials, goods or supplies are necessary to perform any of the one hundred experiments or to make any of the 25 apparatus. Everything can be constructed and accomplished by means of this outfit, two hands, and a screw-driver.

The outfit contains 114 separate pieces of material and 24 pieces of finished articles ready to use at once.

Among the finished material the following parts are included: Chromic salts for battery, lamp socket, bottle of mercury, core wire (two different lengths), a bottle of iron filings, three spools of wire, carbons, a quantity of machine screws, flexible cord, two wood bases, glass plate, paraffine paper, binding posts, screw-driver, etc., etc. The instruction book is so clear that anyone can make the apparatus without trouble, and besides a section of the instruction book is taken up with the fundamentals of electricity to acquaint the layman with all important facts in electricity in a simple manner.

We guarantee satisfaction.

The size over all of the outfit is 14 x 9 x 2 3/4. Shipping weight, 8 lbs. No. 2002 "The Boy's Electric Toys," outfit as described.....\$6.75

IMMEDIATE SHIPMENT

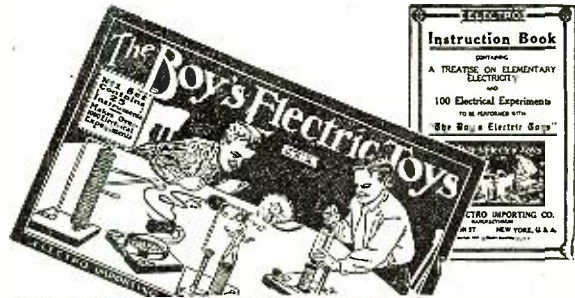

\$6⁷⁵

No. 2002

"The Livest Catalog in America"

IN this cyclopedia you will find all about radio. One of the greatest catalogs of its kind in print.

You will find in it dozens of wireless instruments of the famous E. I. Co. make.

Other things you will find listed in this catalog: Electrolytic Interrupters, Bulldog Spark Coils, Chemical Outfits, Code Practice Sets, Primary Batteries, Storage Batteries, Hydrometers, Volt and Ammeters, Batterymeters, Electrolytic Rectifiers, Rheostats, Tesla Coils, Microphones,

Loud Talkers, Electro-magnets, X-ray Tubes, Telephones, Magnetos, Low Tension Transformers, Books, etc., etc. IN A WORD THE MOST COMPLETE CATALOG IN PRINT.

FREE with this wonderful cyclopedia —20 coupons for our 160 page Wireless Course in 20 lessons 350 illustration, 30 tables. Catalog explains how you can get this Course absolutely free.

The Electro Importing Co.,
231-A Fulton Street New York
"Everything for the Experimenter"

ELECTRO IMPORTING COMPANY
231-A Fulton St., New York City

I enclose herewith 10 cents in stamps or coin, to cover postage, for which please send me your latest Cyclopedia Catalog No. 23 as described.

NAME

ADDRESS

STATER. N. 1-21

(Continued from page 474)

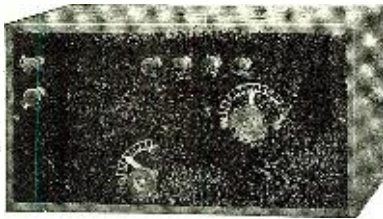

Hook 'Er To Yer Bulb 200M-P. R. L. TUNER

Something new, using a vario-coupler wound with 1/4" copper strip. Very efficient and selective, also including our special variometer. Just as efficient as any Paragon. Weight 5 lbs. Price, \$25.00—add P.P.

KNOCKED DOWN PANEL

Set it up, save money. Consists of Formica Panel—drilled ready for parts, 1 Rheostat—one 11 Plate condenser, H.V. switches, points, base and necessary binding Posts. V.T. socket \$1.00 extra. Shipping weight, 4 lbs. Price, \$8.00. Add Parcel Post.

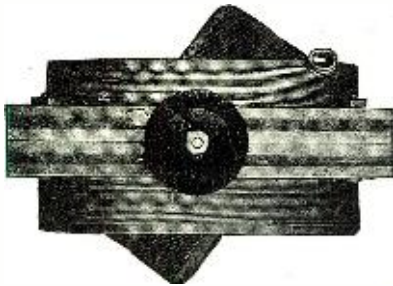

ELLIPTIC VARIOMETER

Embodying a new principle. Most efficient made. Same as used by us in our P.R.L. Tuners. Shipping weight 3 lbs. Price, \$5.00. Mounted in hard wood finished case, formica top, binding posts, scale. Complete, \$7.50. Add Parcel post.

RHEOSTAT

Smoothest running that's made for panels. Auto stop that prevents burning out filament. Weight 1 lb. Price, \$1.75. Add parcel post.



KNOCKED DOWN CONDENSERS

Assemble and save money.

11 Plate	\$1.80
21 Plate	2.25
41 Plate	3.20

Add P.P.



20,000 METER TUNERS. Arlington 5,000 Meter Tuners. Weight 3 lbs. Price, \$10.00. Get all the Arc signals going. Add P.P.

10 cents brings complete catalog full of dope.

TRESCO, Davenport, Iowa

R. T. S. DETECTOR PANEL
Less Tube and Batteries \$11.25

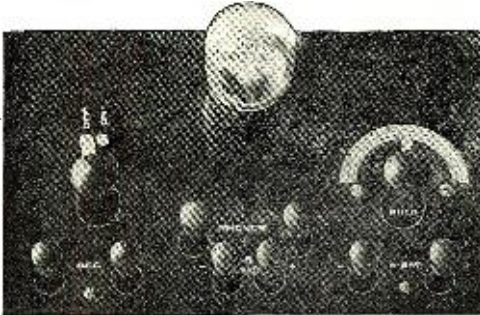

ORDER DIRECT FROM THIS AD

RTS-Switch Points 7/32" x 7/32" x 1/4"	Complete with Screws Per Doz. \$.24
RTS-Dial Indicators, Complete with Knob	\$.80
The Original RTS-Grid Condenser	\$.30
RTS-Panel Rheostat Complete	\$ 1.45
RTS-Switch Levers	\$.40

When Ordering Allow Shipping Expense
Send for Circulars

RADIO TESTING STATION
BINGHAMTON, N. Y.

WHETHER YOU ARE IN THE MARKET TO BUY OR SELL, THE CLASSIFIED COLUMNS OF RADIO NEWS WILL GET RESULTS FOR YOU. TRY THEM.

It will be noted in both circuits that a variable resistance is connected in series with the plate battery of the detector tube in order to secure the necessary adjustment for rectification.

It is possible to connect a number of steps of radio or audio frequency in cascade; or a combination of both may be employed. During the war such practice was essential in connection with small loop antennae. Three steps of each kind of amplification is considered a practical maximum. If amplification is carried on to a higher degree certain reactions will occur which will cause disturbing noises in the receiver unless special precautions are taken.

In conclusion, the advantages of the radio frequency amplifier are:

- (a) Reception of very weak signals otherwise impossible to be heard with other methods.
- (b) Small cost and simplicity of construction.
- (c) Elimination of interfering signals of slightly different frequency.

Baltimore, Md., July, 1920.

Comparison of Modulation Methods in Radio Telephony

(Continued from page 440)

duce the same effectiveness, when the power modulation is complete; and three times as many when the modulation by the latter method is 75%.

4. Amplification of the modulated output of an oscillator to get increased range may result both in reduction of the percentage modulation and in distortion, particularly if the amplifier is biased by a grid leak resistance. The amplitude of the impressed radio voltage must be carefully controlled so as not to exceed the cut-off and saturation points on the amplifier characteristic and the grid of the amplifier should be battery biased. The method is inferior to others that are described later.

5. Reducing the impressed radio voltage as described in (4) results in improvement of wave form, but at the expense of a reduction in power. If the impressed voltage is so high that half the radio cycle is suppressed the distortion is such that the fundamental, 2nd, 4th and 6th harmonics of the modulating frequency have the ratios 0.785, 0.333, 0.067, 0.029. The intensity of the fundamental in a distant receiver is

I
— (= 1.37 times its value were the impressed voltage reduced so that no distortion occurred. This case corresponds to complete modulation downward and 37% modulation upward. The increased signal intensity of 37% over the non-distorted case is not sufficient, in view of the committant distortion, to warrant its use. The curves of Fig. 14 show the relative intensities obtained under different conditions of over-running of the characteristic curve.

6. For high power output it is generally preferable to use one set of tubes as amplifier and another set as modulator rather than all of the tubes as amplifiers for a previously modulated voltage; but this is only true when the filament emission is sufficient to permit upward modulation in the first case of at least 45%.

7. Impressing the speech frequency on the grid circuit of the amplifier gives modulation without distortion provided the operation does not exceed the saturation or cut-off parts of the characteristic curve of the amplifier.

(Continued on page 478)

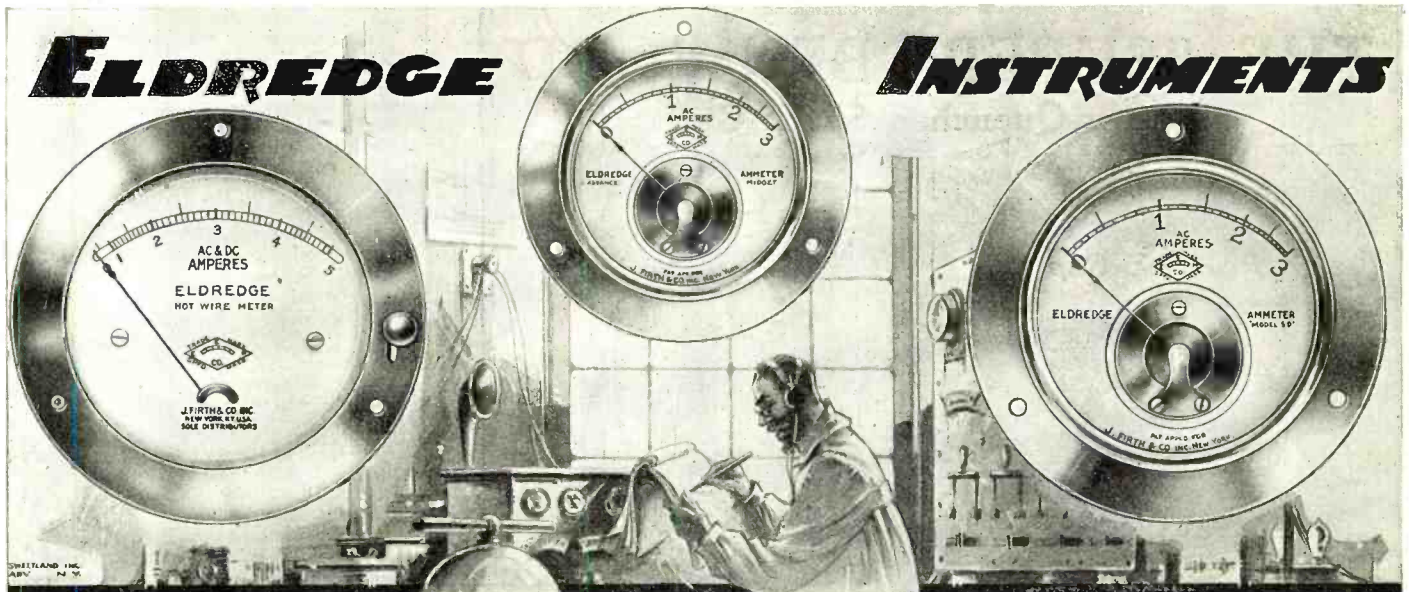

Absolute Dependable Accuracy—Low Priced

The Wireless amateur has always asked for a set of good looking, neat and compact electrical measuring instruments that were unflinchingly accurate and reasonably priced.

ELDRIDGE Instruments fill all of these requirements. They are designed and manufactured by a firm world renowned for creating the most accurate type of miniature electrical measuring instruments.

Notes on all types: Scales calibrated individually to ensure absolute accuracy—polished nickle finish—flush mounting.

RADIO FREQUENCY AMMETERS AND MILLI-AMMETERS. Overall diameter 2 7/8". Ranges 0-600 milli-amps; 0-1, 3 and 5 amps. Price, \$7.00.

ADVANCE "MIDGET" AMMETERS AND VOLTMETERS. Ideal for small panel mounting. Embodies the improved French movement. Supplied in 12 ranges for D. C. and A. C. Price \$8. Overall diameter 2 1/2".

MODEL S-D, A. C. AMMETERS AND VOLTMETERS. Designed especially for 60 cycle transformer primary circuits. Overall diameter 2 7/8". Voltmeters, \$10.00; Ammeters, \$9.50.

Ask your dealer for literature on these instruments. If he cannot supply you, write us direct, giving his name and address.

JOHN FIRTH & CO., Inc., 18 Broadway, New York

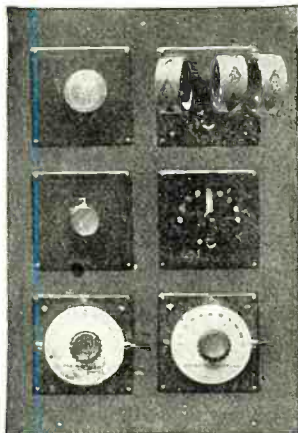

Six Panel Unit Set

Comprising a combined Tuner and Detector to receive all local stations and practically any large station in the world. Everything necessary for the operation of the set, including detector tube, "B" battery, head phones and a set of 11 coils, can be had for \$75.00 complete. (Purchaser to furnish panel board and "A" battery.) This set will give greater satisfaction than any outfit at anywhere near this price. Expansion possibilities unlimited.

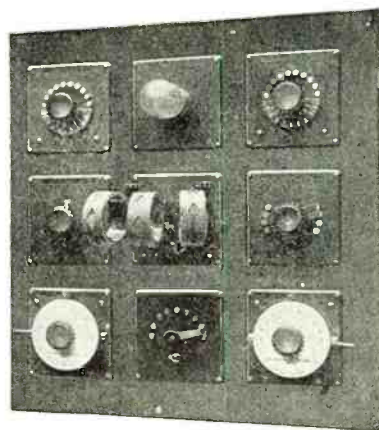

Nine Panel Unit Set

Comprising the same six panels shown above, and either three additional panels to give one step of amplification, or three panels to increase the efficiency of the original six. The former will add about \$23.70 to the cost of the original six; the latter about \$12.10.

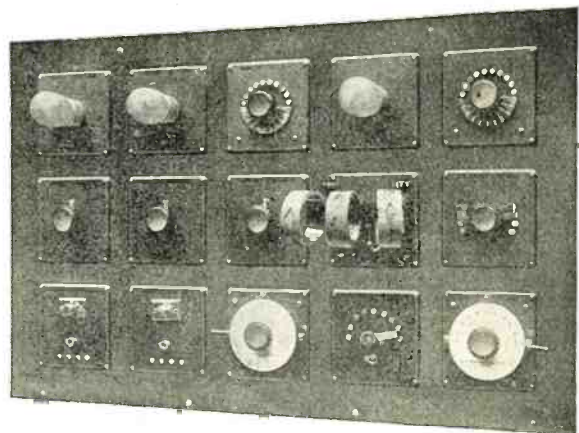

Fifteen Panel Unit Set

Comprising the original six panels, with either of the additional three panels included in the Nine Panel Set, and also two additional steps of amplification. Thus for a total of about \$134.50, or \$146.10, a full Fifteen Panel Set that will outdo any other receiving apparatus may be had.

Newest Ideas in De Forest Unit System Receiving Apparatus

ADVANTAGES of the Unit System include extreme economy due to the simplicity and interchangeability of the units; convenience in arranging circuits to the individual need; and greater operating efficiency due to the engineering design and quality of the instruments. The Unit Sets shown here are a few examples.

DE FOREST RADIO TEL. AND TEL. CO.

Manufacturers and Inventors of High-Grade Radio Apparatus

1415 Sedgwick Avenue, New York, N. Y.

LEE DE FOREST, Inc., Western Distributors

351 Third Street, San Francisco

THE "SUPER" BENWOOD

Rotary Quenched Spark Gap

EFFICIENT AND PRACTICAL

SILENT IN OPERATION

A Real DX Gap

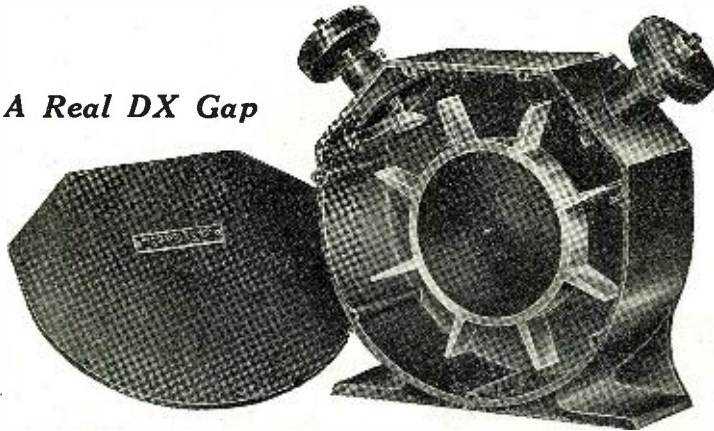

A SOLID ONE PIECE BAKELITE CASTING
HIGHLY POLISHED

Something entirely original in spark gap design,
at a price that you can afford to pay.

Stronger and lighter than aluminum. No metal being used in casting thus eliminating any and all electrical losses. Scientifically correct in every detail. Impossible for insulation to ever break down. Guaranteed for life.

Disc weighs only 1/2 pound, yet it has the same sparking surface as the larger BENWOOD discs that are so well known throught the country. Dimensions are, 6 inches in diameter, 3/4 inch in width and the teeth or sparking surface are tapered down to less than 1/8 inch in thickness. This gives the "quick break" that is theoretically proper and so highly desirable. Smallest fractional H/P/ motor will drive the gap with ease. Furnished complete with flexible coupling all ready to connect to any motor, regardless of size. Furnished with 4, 8, 12 and 16 point rotors, merely specify type desired.

Price as shown, \$25.00

THE BENWOOD COMPANY, Inc.

13th and Olive Streets

ST. LOUIS, MO.

(Continued from page 476)

8. With modulation on the grid of a separately excited oscillator (amplifier) the load must be adjusted to $\frac{1}{3}$ of the tube resistance for maximum effectiveness. The adjustment is made by changing the turn ratio on the transformer.

9. With all modulation other than the grid type the load is made equal to the tube resistance.

10. Two different actions may occur in modulation on the amplifier grid circuit, (1) modulation by change in amplification; (2) modulation by rectification. Both are due to the shift of the operating point of grid bias by the modulating voltage. The latter action is generally the more effective.

11. When increased output is desired thru amplification, the grid method of modulation on the amplifier is superior to first modulating the master oscillator and then amplifying its output. For VT-2 tubes the theoretical ratio of effectiveness in the two cases is approximately 468 to 352 in favor of grid modulation.

12. With a given total number of tubes it is better to use one-half of them as an amplifier unit and the other half for power modulation of these, provided 100% modulation is obtained, than it is to use all of the tubes for amplification and modulate on their grids. For VT-2 tubes the theoretical ratio of effectiveness in the two cases is approximately 1410 to 936 in favor of power modulation, or 67% modulation by the latter method is equivalent to the best obtainable by modulation on the grid.

Thermionic Vacuum Tube as Detector, Amplifier and Generator of Electrical Oscillations

(Continued from page 446)

In Fig. 3 the constant current is insured by using in the anode circuit a saturated diode as a limiting device. In this case the indicating instrument on the output side must be of a kind that takes a current which is small relative to the current passing thru the tubes shown. If the frequency of the E.M.F. applied to the anode is of audible order or higher, a choking coil may be used instead of the saturated diode. In Fig. 4 the indicating instrument should be of low resistance and able to pass the whole current, or for sensitiveness might be a differential galvanometer.

In general these extreme types are departed from in the construction of amplifiers and cascade connections are formed by the use of resistances, condensers, or transformers in the manners indicated in Fig. 5 and Fig. 6.

Various experimental illustrations were given in the lecture of the amplifying properties of single tubes and cascade amplifiers. One of these consisted in passing the discharge of a radium clock into the anode circuit of a cascade amplifier and thus making the striking of the clock audible to the audience. The radium clock, it may be explained, consists of a pair of insulated metal leaves in a tube containing a little radium. When they diverge in consequence of an accumulation of electricity upon them they touch stationary side electrodes and are discharged, to begin the process of accumulation again.

APPLICATIONS OF TRIODE TUBES.

In the second lecture various applications of the properties of the triode tubes were discussed. By the expenditure of a very small amount of power in the grid circuit

(Continued on page 480)

TUNING TRANSFORMERS.

Immediate deliveries while they last.

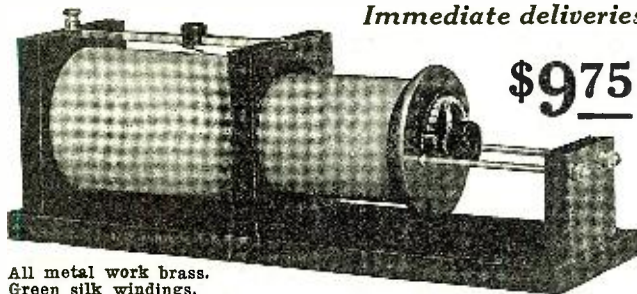

\$975

PRICE
and
QUALITY

All metal work brass.
Green silk windings.

Manufacturer's Prices

Direct from Manufacturer to you. You save 30 to 40% paid dealers.

Both instruments mahogany finish.

Range 140 to 3500 meters Base 18 inches ABSOLUTELY GUARANTEED.

Secondaries, divided into 12 parts.

Primary Dead end switch.
18 single taps, 16 spaced taps made for most sensitive adjustment possible.

Panel heavy hard rubber 9/32".
All metal work nickel plated.
Green silk winding.

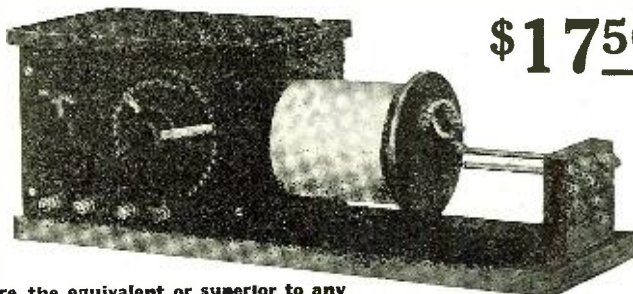

\$1750

These transformers are the equivalent or superior to any similar instruments on the market. Money back after 3 days if not satisfied as represented.

G. M. PROUDFOOT, 361 East Ohio St., Chicago, Ill.

Signals Come In One Clean Clear Note With Brandes Matched-Tone Headsets

A pair of powerful binoculars with each eyepiece perfectly focused brings the blurred detail of the distant landscape into easy range of your vision, Brandes Matched-Tone Headsets, with their earpieces tuned in exact unison, bring the ordinarily blurred and indistinct signals within easy range of your ears.

You couldn't see clearly with binoculars if the eyepieces were not each perfectly focused and likewise you cannot hear signals clearly with headsets unless the earpieces are perfectly matched in tone. This matched-tone feature is found only in

Brandes Matched-Tone Headsets

They are guaranteed by money back to be better for clearness, sensitiveness, distance and comfort than any other headset on the market. If you want to know

real headset satisfaction try a Brandes Matched-Tone Headset. They are made in three styles to cover every type of wireless work.



"Superior"—weight 14 oz., complete with head band and polarity indicating cord. Price \$8.00.



"Transatlantic"—weight 11 oz., complete with head band and polarity indicating cord. Price \$12.00.



"Navy Type"—weight 9 oz., complete with head band and polarity indicating cord. Price \$14.00.

Here is our offer. Order one of our headsets. Try them for ten days in comparison with the phones you have now. If they aren't better for clearness,

sensitiveness, distance and comfort than what you are using, return them to us and back comes your money immediately and without question. *Send 5c for catalog "G"*

C. BRANDES, Inc., Room 823, 32 Union Square, New York City
WIRELESS HEADSET SPECIALISTS



ELECTROSE KNOBS AND INSULATORS

The insulator shown is of the popular ball type. Made of the world famed Electrose. Shipping weight each 1 lb. While they last.....ca. \$0.30

The manifold qualities of Electrose are too numerous to be mentioned here. The knobs pictured to the left are of Electrose ruggedly constructed to avoid chipping. The metal parts are of brass, heavily nickle-plated. No. EK-1041 has a 3/16" bushing and No. EK-1042 a 1/4" bushing. Both knobs are same size as cuts. Shipping weight 2 ozs. each.

No. EK-1041, \$0.16; No. EK-1042, \$0.17



MURDOCK ROTARY SPARK GAPS

A good gap of substantially low cost with a dependable universal motor and a moulded rotor having 12 fan blade electrodes and 2 stationary Electrodes. Rotor runs absolutely true; speed about 4,000 R. P. M. Shipping weight 10 lbs. \$18.50

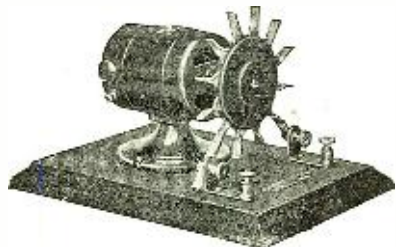

SWITCH POINTS—MINERALS—BRASS SCREWS AND NUTS

Switch points illustrated are 1/4 x 1/4 tapped for 6/32 screws. Have top edges beveled and are heavily nickle-plated. Are packed in parcels of 24 with 24 6/32 brass screws. Shipping weight 2 ozs. per dozen.

No. 396 switch points, 2 doz., \$0.60; 1 doz., \$0.35

Our minerals cannot be surpassed for sensitivity. Each crystal tested separately. Put up in small neat packages with shipping weight of 4 ozs.

No. SFB-5 pkg. of fused silicon—liberal amount..... \$0.30

No. GB-10 pkg. of galena crystals..... 0.25

For some time past there has been a scarcity of brass machine screws and hexagon nuts. However, we have received a large supply of these items and can offer them as follows:

6/32 brass machine screws 5/8 in.—shipping weight 1 oz..... per doz., \$0.10

6/32 brass hexagon nuts—shipping weight 1 oz..... per doz., 0.10

Send 15c. for our large illustrated catalogue. This amount will be credited on your first order for \$1.50 or over. High printing costs make free distribution impossible.



ELECTRICAL SPECIALTY CO.

Dept. R. 48-50 So. Front St., Columbus, O.
 Dept. R. 20 N. 9th St., Philadelphia, Pa.

(Continued from page 478)

it is possible to liberate much greater power in the anode circuit, and therefore the grid can be utilized for controlling electrical or mechanical movements by means of larger changes in the plate circuit. For instance, a pendulum can be sustained in oscillation by a magnet in the anode circuit when the impulses it receives are timed by another pendulum of the same natural period inducing minute currents in a winding in the grid circuit.

A small motor was shown, consisting of an ebonite disc with iron teeth mounted on a spindle so that the teeth pass in front of two electromagnets, one of which is in the grid circuit and the other in the plate circuit. A tooth passing the grid electromagnet stimulates a flow of current in the anode electromagnet, and this pulls round the next tooth. Speeds of rotation up to 100 per second have been obtained with this simple mechanism.

This automatic regulation of anode current by grid E.M.F. was also illustrated by the maintenance of a tuning fork, one prong of which induced E.M.F. in the grid circuit and the other of which was pulled or pushed by an electromagnet in the plate circuit.

ELECTRICAL OSCILLATIONS.

Electrical oscillations, as well as mechanical, can be maintained by the aid of triode tubes. All that is necessary is to arrange that the sustained oscillating circuit acts upon the grid and is acted upon by the fluctuating anode current concordantly.

The simple circuit shown in Fig. 7 was demonstrated, and by aid of a tuned circuit connected to a crystal detector and galvanometer was shown to be traversed by oscillatory current. But the most striking way of detecting the existence of oscillations in one set of apparatus is to bring near it another set of apparatus oscillating at nearly the same frequency. What happens then is analogous to the well-known facts on relative motion. For instance, if two trains are traveling on parallel rails in the same direction at nearly equal speeds, it is possible for an observer in one train to read the labels on the windows of the other; but if the difference of speed increases, reading becomes more difficult, and is impossible if one train is stationary and the other moving quickly. In the same way, in order to examine an oscillatory motion in one apparatus we might make a second oscillate at nearly the same frequency, the relative oscillation in this case having a frequency equal to the difference of the respective frequencies. The detection of an electrical oscillation by observing its motion relative to an oscillation of nearly equal frequency is called the beat method, or the heterodyne method; but besides this bringing together of the two oscillations, it is necessary to provide that the relative oscillation, which is of frequency equal to the difference of the respective high frequencies, shall be rectified so that pulses of current of the different frequency can be sent thru a telephone receiver and made audible. When the sets on the table were oscillating at the rate of 500,000 and 500,100 per second, and when one set was arranged as a rectifier, as shown in Fig. 8, the beat note was made audible to the audience by passing the pulsating rectified current into an amplifier and, after this magnification, thru a telephone.

CUMULATIVE RECTIFICATION.

The circuit of Fig. 8 rectifies on account of the fact that when the grid is positive some electrons land on it and when it is negative none can do so. The condenser accumulates these electrons with the result that the grid becomes so negative that the anode current is greatly diminished. The resistance in parallel with the condenser

(Continued on page 482)



C-W



Apparatus

Increased production has enabled us to reduce the price of our well known Type 127 Hot Wire Ammeters to \$7.75 Every C-W Station should have a radiation ammeter. They are also suitable for measuring filament currents either AC or DC. Supplied in a variety of ranges and for either flush or front of board mounting.

Our Type 156 Socket is adapted for either transmitting or receiving tubes. Change over is made by means of two screws in base. A rugged, attractive, reliable socket with positive contact springs. Price \$1.75



A 7 ohm rheostat for regulating the filament current in either transmitting or receiving tubes. Carries 1.5 Amperes. Smooth operation of switch arm. No grating, no clicking. Cut shows Type 214A for mounting back of panel. Type 214B made for portable or front of panel use. Price \$2.50

Send for Bulletin 904N

GENERAL RADIO COMPANY

Massachusetts Ave. and Windsor St., CAMBRIDGE 39 MASSACHUSETTS



Pick'em Out



If you are in need of small parts for your set.

TYPE S14 TYPE 24

WE have the following parts in stock for immediate shipment. All manufactured by us and carrying our guarantee.

Type S17—Nickle Plated Crystal Cup	\$.35
Type S21—Super-sensitive mounted galena crystal.....	.50
Type S26—Nickle Plated Binding Posts12
Type S27—Insulate Knob Binding Post12
Type S24—Aluminum Socket60
Type S10—Single Socket	1.10
Type S 3—Double Socket	3.00
Type S 4—Triple Socket	4.00
Type S14—Navy Cage Type Rheostat	2.25
Type S15—.0005 Grid Condenser35
Type S16—.002 Telephone Condenser35
*4" x 3-16 Grade XX Bakelite Disc.....	.30
*6" x 3-16 Grade XX Bakelite Disc.....	.50
*3" x 16 x No. 38 Litzendraht Wire, per ft.....	.01 1/2

*A limited quantity of these articles in stock.



TYPE S17

**TYPE S 30
GRID-LEAK
CONDENSER
50c**

A combination of a one megohm leak and a .0005 condenser.

The finest obtainable.



TYPE S4

Ask your dealer for Radio Service Products. If he can't supply you order direct.

RADIO SERVICE & MFG. CO.

LYNBROOK, L. I., NEW YORK

Your Duo-Lateral Wound Coils Are Ready



"SERVIMUS"

JUST a word of explanation: Our first advertisement caused such an upheaval in radio circles that we were swamped with inquiries. Indeed, one large manufacturer of radio apparatus immediately placed his contract with us, taking over our entire output. As a result, we were obliged to turn down orders.

THAT was up till a short while ago. Now we have succeeded in doubling our productive capacity, and Duo-Lateral Coils are available to everyone in the radio field. We can make prompt shipments from stock. *Your DUO-LATERAL COILS are ready to be shipped the moment your order is received*



REMEMBER: DUO-LATERAL COILS are recognized for:

1. Lower natural period.
2. Lower high-frequency resistance.
3. Very low distributed capacity.
4. Lower direct current resistance.
5. Higher self-inductance.
6. Mechanically stronger.

Bulletin P-IR, containing valuable engineering data, constants and prices of numerous sizes of Duo-Lateral Coils, covering practically every wave-length used, is yours for the asking.

TO DEALERS: OUR DISCOUNTS ARE GENEROUS

PACENT ELECTRIC COMPANY, Inc.

We now represent the WIRELESS IMPROVEMENT CO. exclusively

Representing: A. H. Grebe & Co., Dubilier Condenser Co., Electrical Products Mfg. Co., Richter-Schottler Co., H. W. Sullivan of London, Rawson Elec. Inst. Co., and others.

150 NASSAU STREET

Telephone Beekman 5810

NEW YORK CITY

Baldwin's réproduce like a phonograph

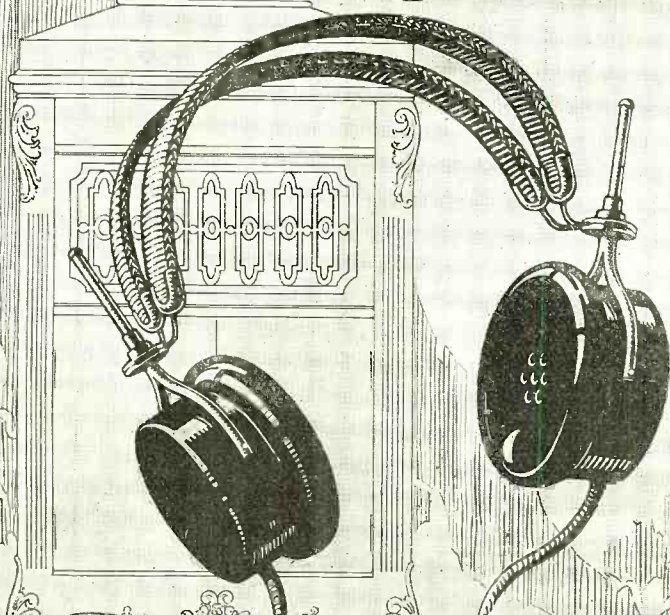

The sound producing elements are the same—a sensitive mica diaphragm which easily responds to the thousands of over-tones of the human voice or any musical instrument.

Their ultra-sensitiveness made them world-famous for the wireless telegraph. Their clear, natural reproduction is making them equally famous for the wireless telephone.

Send, direct or ask you dealer, for new Baldwin booklet. It illustrates and describes fully.

JOHN FIRTH & CO., Inc.
18 Broadway - New York

Sole distributors of
Eldredge Measuring Instruments
Kolster Decremeter.
U. S. Bureau of Standards Wavemeter.
Navy Standard Leyden Jars.
Brownlie Adjustable Telephones.

BALDY FOR LAND SEA AND IN THE AIR PHONES

C W ACME APPARATUS



MODULATION
TRANSFORMERS

1 1/2 HENRY
CHOKE COILS

C W POWER TRANSFORMERS FILAMENT HEATING TRANSFORMERS

The C W Power Transformer may be used with rectifying tubes for providing Direct Current and Voltage or may be used for applying high voltage Alternating Current directly on the oscillation tubes.

As Transformer Specialists we are prepared to build C W Power Transformers of any size on special order.

Write for Bulletin 113

ACME APPARATUS CO., 251 WINDSOR STREET
CAMBRIDGE 39, MASS.

Transformer and Radio Engineers and Manufacturers

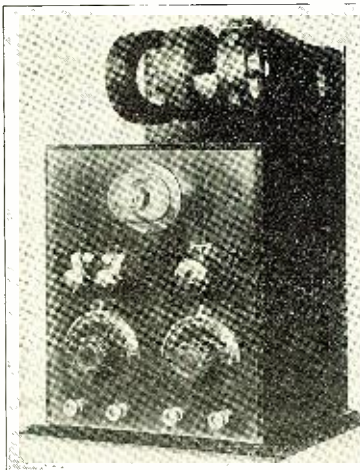

REYNRAD SPECIALTIES

The Reynrad multi-wave tuner and audion detector is an exceptionally efficient outfit suitable for all wave-lengths and at a price within reach of all. Cabinet mahogany finish, panel of Grade XX bakelite.

Complete Tuner and Detector.....RR-74, less coils and batteries with detector bulb.....\$60.00
When the RR-74 is used in conjunction with the RA-72 Two stage amplifier signals may be copied from almost unbelievable distances. The RA-72 amplifier positively will not howl or squeal. Cabinet mahogany finish panel of grade XX bakelite.

RA-72 Two Step Audio Frequency Amplifier with Bulbs.....\$55.00
With the RCR-35 complete receiving set, ships have been repeatedly heard over a distance of 1,500 miles over land and amateurs copied over 1000 miles away. These receiving records place the Reynrad crystal outfit on a par with numerous audion sets.

Price of RCR-35 complete with 3,000 ohm phones\$30.00

SHORT WAVE COILS

You can now get short wave coils wound on 4" bakelite tubing with De Forest standard plugs to fit your De Forest Coil mountings. A set of three will bring in amateur station as you never have heard them before. An additional secondary coil will make your receiving outfit equally efficient for ships on 600 meters. state wave length desired, 175-300 or 300-600.

Short Wave Coils.....\$2.00 each

De Forest Standard Plugs for HC or DL coils......65 each

We carry in stock a large supply of standard apparatus such as: phones, condensers, rheostats, bulbs, sockets, amplifying transformers, coil mountings, etc.

Complete stock of De Forest DL Coils.
Catalogue and bulletins for 6c. Correspondence solicited

REYNOLDS RADIO SPECIALTY COMPANY
729 So. Prospect Street - - - Colorado Springs, Colorado

COMPLETE WALL SET MAGNETO TELEPHONE

Western Electric Type

Slightly used but guaranteed to be in A1 working order. The cabinet is of polished oak, piano finish, within which is contained the powerful magneto, the 300 Ohm polarized ringer, an induction coil. The magneto is exceptionally efficient, being of the two bar type with brass gear transmission. The extra sensitive microphone, mouthpiece and two gongs are mounted on the front of the cabinet. Guaranteed to work over 20 miles.

Long Distance Telephone Set—One station—Shipping weight, 15 lbs.....\$7.00

Two stations—Shipping weight, 25 lbs.....\$13.00

Send 6c in stamps for our big 80 page Wireless and Electrical Catalog No. 23.

THE ELECTRO IMPORTING CO., 231 Fulton St., New York

(Continued from page 480)

is called a grid leak, and is placed there to provide for the escape of the accumulated electricity gradually. Without it the grid would remain permanently negative and the anode current permanently zero. Starting with the difference of the frequencies as high as 10,000 per second and then altering the condenser in the circuit of higher frequency so as to reduce the difference, an adjustment is shortly reached at which the difference is made audible as a high note. Continuing to increase the capacity of the condenser, the note descends in pitch until the difference of the high frequencies is about 30 per second and ceases to be audible. Continuing to increase the capacity, the point of exact equality of the high frequencies is past, and, the circuit undergoing change, attains a frequency 30 vibrations per second lower than the other, when we again get the heterodyne note. Continuing to move the condenser in the same sense, the difference of the frequencies now increases and the pitch ascends thru many octaves until at last too high for the telephone to chronicle. It is noticeable that the beat note is loudest at medium frequencies on both sides of the in-tune adjustment. This is chiefly on account of the idiosyncrasies of the telephone diaphragm, but partly on account of variation in the sensitiveness of the ear.

APPLICATIONS OF THE BEAT PRINCIPLE.

In wireless telegraphy signaling can be carried on by making relatively slight changes in the frequency of a transmitting station when the reception is carried out by the heterodyne method, for the changes in frequency, when combined with oscillations of steady frequency at the receiving station, produce changes of the note in the telephones of the receiving operator sufficient to mark the Morse signs. The changes of frequency may be made by altering the capacity or the inductance of the apparatus at the sending station. This may be demonstrated with the present apparatus by moving the hand to and from a condenser or by opening and closing a loop of wire in the neighborhood of the coil. Change of filament current was shown, also, to produce changes in the frequency of the apparatus used as the sending station.

Another piece of apparatus was made in precisely the same manner as the former pair of oscillating circuits, but with smaller coils and with smaller condensers. As a consequence, this was much more sensitive to changes in the value of the capacity or the inductance or of other factors. Such a pair of circuits can be used as an induction balance; for a piece of metal, especially if in the shape of a closed ring of wire, if held near one of the coils, alters the frequency of one set and, therefore, the pitch of the heterodyne note. It is possible to distinguish between a piece of iron and a piece of copper of the same size and shape, for the induced currents in the piece of metal under test are responsible for the alteration of the effective inductance and these currents depend upon the effective resistance of the metal. The arrangement is so sensitive that it easily perceives the conductivity of the burning gas of a Bunsen flame. It is similarly sensitive regarding changes of the capacity of the condenser in either set. For example, the approach of a piece of ebonite towards the plates of a condenser, or the insertion of a small piece of paper between such plates, produces a great change in the note. Again, the pouring of a little ether vapor into a condenser and the blowing of it out produces a change in the note. If an electroscope with two side plates be connected, in parallel to one of the condensers, the divergence of the leaves is sufficient alteration to the electrical capacity of the arrangement to produce a distinct change in the beat note.

"The Greatest Radio Catalog in the World—" The Universal Verdict of Tens of Thousands of Radio Amateurs
DUCK'S No. 14 Big 200 Page Wireless Catalog

A Veritable Treasure House of Everything Worth While and Dependable in Radio. The largest, most comprehensive, artistic and educational wireless catalog published. The Beacon Light to guide you right in the se-

lection of your radio purchases, and at prices that will command your attention. Every instrument guaranteed with privilege of return if not satisfied.

Mail 12 cents

in stamps or coin (not sent otherwise), which amount you are privileged to deduct on first dollar purchase. Revised price list to first edition of catalog, with prevailing prices, mailed on request.

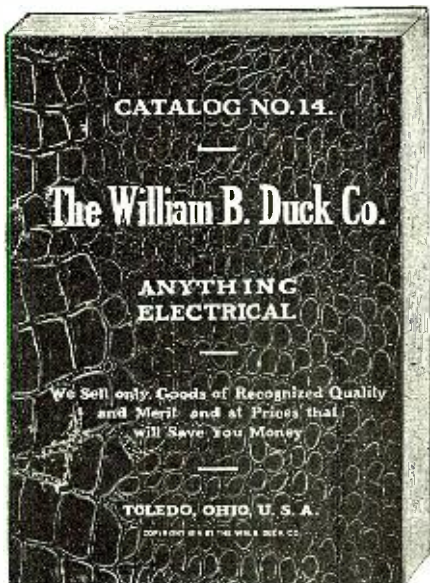

Announcing Permanent Reductions on 3 of our most popular Radio Instruments

The demand last month for our Navy Type, Arlington, and No. 7721 Receiving Transformers at the greatly reduced prices convinced us that with large quantity production, because of the exceedingly attractive prices on these instruments, we can continue to maintain these low prices. We therefore announce the following permanent reductions on these instruments.

- Model 588 Navy Type Receiving Transformer, Former Price \$27.50. **New Price \$21.95**
- No. 1091 Improved Type Arlington Receiving Transformer, Regular Price \$15.00. **New Price \$11.95**
- No. 7721 Receiving Transformer, Regular Price \$9.00. **New Price \$7.50**

Send your order immediately for your choice of these popular instruments.

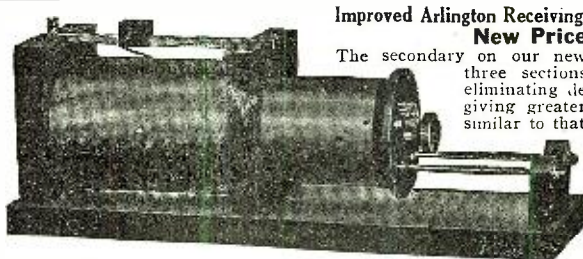

**Improved Arlington Receiving Transformer, Regular Price \$15.00
 New Price, Only \$11.95**

The secondary on our new type Arlington is divided into three sections, with two dead end switches, eliminating dead end effect and harmonics and giving greater selectivity. The end support is similar to that on our Navy, permitting a looser coupling. The base and primary end pieces have a spline to prevent warping or damage in transit. This feature is also on our Navy. It is a beautifully finished instrument.

Improved Type Sayville Rotary Gap
 Embodies the latest and best features in Spark Gap Construction

Our New Type Sayville Rotary Gap is, we believe, far in advance of any rotary gap on the market within a range even of twice the price. It is the final development of many different types made in our experimental Radio Laboratory. It fulfills every requirement of the ideal rotary gap. It is neat and attractive in appearance; simple and durable in construction; possesses a wonderful motor; has a cast aluminum rotary wheel, beautifully polished; every part is in perfect alignment; there is no wobbling of the rotor; produces and maintains a clear and pure 500-cycle note; is instantaneous in action; permits of no dragging of the spark; has contacts of tempered flat copper of proper length and width, easily and quickly removable, and inexpensively renewable; the stationary contacts are adjustable to any length.—\$27.50

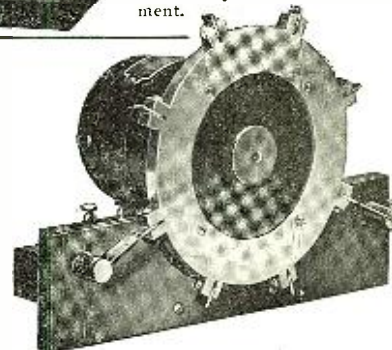

THE WILLIAM B. DUCK COMPANY, 231-233 Superior Street, TOLEDO, OHIO.

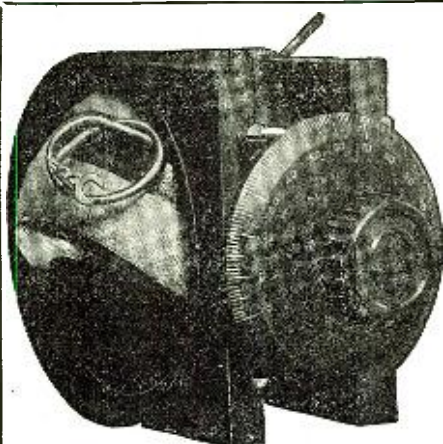

- Variometer complete with knob and dial.....\$6.50
- Without knob or dial..... 5.75
- Variocouplers of same general construction 7.50

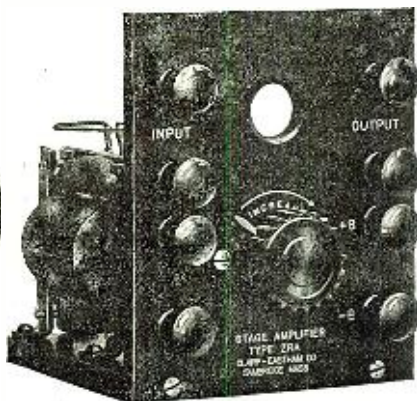

- Tube Control Panel.....\$12.00
- One Stage Amplifier Panel 18.00
- Two Stage Amplifier Panel 40.00
- Amplifying Transformer.. 6.50
- Amplifying Transformer without panel 4.00
- Rheostat only 1.20

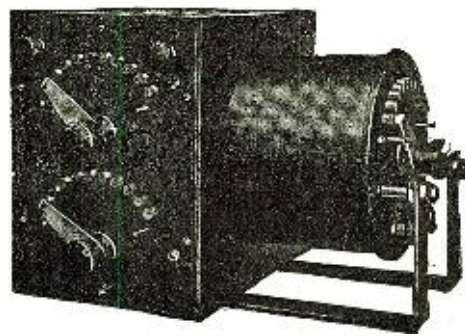

- Radion Receiving Transformer\$14.00
- Detector and Amplifier Tubes 5.00

Our advertisements are not filled with superlatives but our products will be found fully equal to the best and are backed by a reputation of thirteen years of continuous manufacture.

Complete Catalogs 6c Stamps

Order from your dealer and remember it will pay you to insist on apparatus manufactured by

CLAPP-EASTHAM COMPANY

120 Main Street,

Cambridge, Mass.

Here It Is!

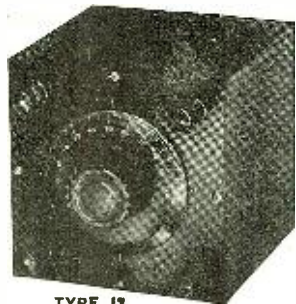

TYPE 12

Lattice Wound Variometers.

Especially Designed to Improve the Short Wave Regenerative Circuit.



TYPE 7

Realizing the need of a neat, compact and highly efficient Variometer for the modern receiving set, we have produced one which we feel will meet these requirements. Type 7 is assembled ready for panel mounting. A 1/4-inch hole drilled in your panel is all that is necessary to mount.

Type 12 is a complete unit, and consists of Type 7 mounted on a 4 1/2 x 4 1/2 inch Bakelite Panel, incased in a mahogany finished cabinet. Four binding posts are provided so connections can be made on any side. Both types are furnished with a standard 3-inch dial and knob, making a very attractive instrument.

PRICES Charges Prepaid
Type 7G. (For Grid Circuits) \$7.50
Type 7P. (For Plate Circuits) 7.50

PRICES Charges Prepaid
Type 12G. (For Grid Circuits) \$12.50
Type 12P. (For Plate Circuits) 12.50

Attractive Proposition to Dealers

A. W. HALLBAUER

1001 N. Lockwood Ave., Sole Agent and Distributor CHICAGO, ILL.

THE LATEST AUDION CONTROL UNIT

A neat and highly efficient instrument which sells at a price within the reach of all.

Price
\$ 12.00



The
**EV-RA-LAB
AUDION
CONTROL
UNIT**

TYPE "D"

Specifications:

Panel: Bakelite XX Dilecto. Size 8 x 9 x 1/8 inches. Handsomely engraved and filled with brilliant white.

Filament Control: EV-RA-LAB Standard six ohm rheostat, which provides single turn adjustment.

Binding Posts: Nickerled with hard rubber tops. Four extra posts are mounted on the Panel so that it may be used with Audio-Trons.

Vacuum Tube Sockets: Standard four prong type with Phosphor-Bronze Contactors.

Miscellaneous: A seven point switch is provided for varying the plate voltage. A single Gang Pull Switch is used for an off and on switch. May be used with any type of tube on the market today.

Order from ad or send 4 cents for bulletins describing our Detector and Amplifier Units.

EVANSVILLE RADIO LABORATORY

1103 South Third St. Evansville, Indiana

HOT WIRE AMMETER

Special Flush Mounting **\$ 8**

Hot wire ammeter Roller Smith with scale 0-1, 0-2 1/2, 0-5.

Sent postpaid for \$8, while they last.

PHILADELPHIA SCHOOL OF WIRELESS TELEGRAPHY
PARKWAY BLDG. BROAD AND CHERRY STREETS

HAVE YOU SOMETHING TO SELL OR EXCHANGE?
A classified ad in Radio News will reach 40,000 at a cost of only 6 cents a word.

A Honeycomb Coil Machine That Works

(Continued from page 442)

OPERATION

In order to wind coils, proceed in the following manner: Glue two layers of thin cardboard around the roller C. When this becomes dry, thread the wire thru the small screw-eye on H, on thru the hole in O and then wrap the wire around a small nail driven into the roller for that purpose. The revolution counter, of course, is not necessary, but is very handy. After a little experience, coils can be very easily wound on this machine.

After winding, a rubber band or two is placed around the coil which is then removed from the machine and dipt in thin shellac. It is then allowed to drip for about an hour, and then baked in an oven for a few hours. The surplus cardboard is pared off from each coil end and they are then ready to mount as the experimenter desires.

It might be well to mention the fact that the notations L and US before the different coils refer to the number of turns, for instance: L-150 or US-150 means a coil of 150 turns and so on.

The connecting rod I should be raised or lowered on H so that it winds a coil just one inch in width. The pivot on H should be moved backward or forward so that when the pivot of I on G is directly above the shaft, H will be perpendicular.

How We Came to Have a U. T. Transmitter on the U. S. A. T. Princess Matoika

(Continued from page 436)

the antenna were started. The 1st was at the 90th turn, the 2nd at the 100th turn, the 3rd at the 110th turn, the 4th at the 120th turn, the 5th at the 130th turn, the 6th at the 140th turn and the 7th at the end of the coil. These taps were also soldered to a seven point switch which was connected to the antenna thru a radio frequency ammeter. We also found that four transmitting tubes would radiate just as much as six so we cut two of the tubes out of the circuit, leaving the set with one oscillator tube and four transmitting tubes. We then decided to try 1000 volts on the plates but were doubtful if the tubes would stand up as they are supposed to stand up to 400 volts only. To secure 1000 volts we impressed 40 volts on the motors instead of the former 30 volts as ordinarily used. This consequently speeded up the generator units which increased the voltage.

Taking precautions to see that the insulation was good and that all connections were proper, we prest the key and adjusted the variable condenser C2. Before we had gone very far the spark had jumped from the fixt to the variable plate and it became necessary to double space the plates. Since this would take time, we decided that we should insert another condenser in series with the variable C2 to reduce the strain. For this purpose we used a 1/2 Mfd. fixt condenser in series with the variable condenser C2 and again prest the key, this time making dots as we were afraid the tubes would break down. As we approached resonance we heard the change in the hum of the generators and the aerial ammeter shot up to 2.5 amps, altho later we often radiated as high as 2.75 amps. This proved to us

(Continued on page 486)

A Combination that Can't be Beaten

For Results—real long-distance signals on short wave lengths you can't beat the



This is the Outfit which made a reputation for itself in the recent QSS tests.

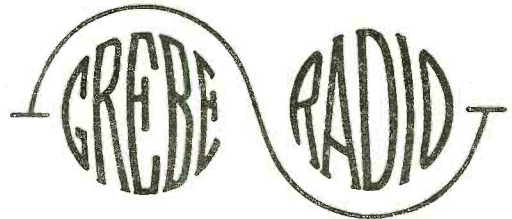

Relay Receiver (Type CR-3)
and
Detector and 2-Stage Amplifier (Type RORD)

You can get into the Big Relay Game and become one of the dependable long-distance men with this outfit.

Inspect this Outfit at your Dealer's. If he doesn't carry our line as yet, drop us a postal for catalogue, mentioning his name.

GREBE RADIO apparatus is licensed under the original Armstrong and Marconi patents.

Central Radio Institute, Independence, Mo.
Continental Radio and Electric Corp., New York.
Detroit Electrical Co., Detroit, Mich.
Doubleday-Hill Electric Co., Pittsburgh, Pa.
Electrical Specialty Co., Columbus, Ohio.
Holt Electric Utilities Co., Jacksonville, Fla.
Hurlburt Still Electrical Co., Houston, Texas
Kelly and Phillips, Brooklyn, N. Y.

Klaus Radio Company, Eureka, Ill.
Manhattan Electrical Supply Co., New York, Chicago, St. Louis.
F. D. Pitts Co., Inc., Boston, Mass.
Leo. J. Meyberg Co., San Francisco, Cal.
Pacent Electric Co., Inc., New York City.
Philadelphia School of Wireless Telegraphy, Philadelphia, Pa.
Western Radio Electric Co., Los Angeles, Cal.

A. H. GREBE & CO., Inc., 72 Van Wyck Blvd., Richmond Hill, N. Y.

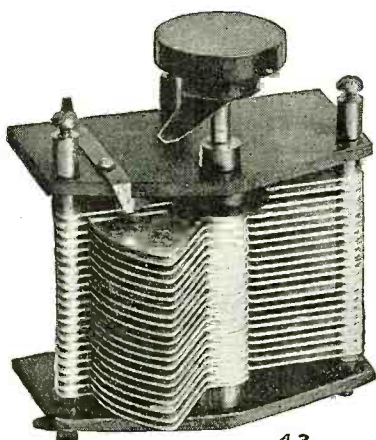

43

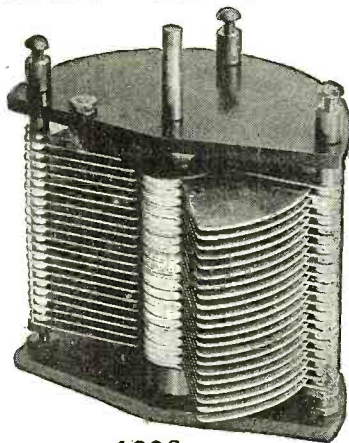

4300

Entire Satisfaction

is what our customers say.

ARE YOU

GETTING ENTIRE SATISFACTION from condensers you have purchased elsewhere?

IF NOT, we are sure you will be pleased with what we are offering, because, we manufacture *only* the BEST.

All we ask is GIVE US A TRIAL.

This month we wish to announce a NEW MODEL of VARIABLE CONDENSER, which will be known as SERIES "T". It is of the same general construction as our SERIES "S" condenser, but is built of heavier material, the aluminum plates being die stamped from 1/32" hard rolled stock. The spacers are also of heavier stock, and the general assembly insures a very rigid instrument. At the present time we are unable to fill orders for the SERIES "S" condenser, as we cannot obtain materials, but can ship the NEW SERIES "T" or the SERIES "L" condenser from stock.

SERIES "T".

No.	Plates	Type	Price
No. 20	2	plate Vernier.	\$2.00
No. 70	7	plate, approx. .0001 m.f.	\$2.35
No. 130	13	" .0002 m.f.	\$2.75
No. 170	17	" .0003 m.f.	\$3.15
No. 230	23	" .0005 m.f.	\$3.60
No. 310	31	" .0007 m.f.	\$4.30
No. 430	43	" .001 m.f.	\$5.25
No. 630	63	" .0015 m.f.	\$7.50

Include postage for one pound to your city.

PRICES

SERIES "L".

No. 2300	23	plate, .00075	\$6.00
No. 4300	43	plate, .0013	\$8.00
No. 6300	63	plate, .002	\$10.00

Include postage for two pounds.

Prices include knob and pointer and mounting screws. Specify whether brass or nickel pointer and screws, and thickness of your panel.

Either style of condenser, fitted with indicating dial at additional cost of 75c.

THE WIRELESS SHOP

511 West Washington St.

A. J. EDGCOMB

Los Angeles, Cal.

**RECEIVED
PAYMENT**

JAN 1 - 1921

CHICAGO RADIO LABORATORY

PER *R. H. G. ...*

**IT MEANS
SOMETHING!**

**GET ONE
OF THESE!**

Among other things, it means that you have made good use of your Christmas money, if you have this stamp on a shipping notice for one of the famous C. R. L. Paragon Regenerative Receivers or some of our other high grade radio apparatus, designed and manufactured with the needs of the "long distance" radio man kept foremost.

Write for our descriptive bulletin J-20, and find out what a wonderful set you can get with that Xmas check.

CHICAGO RADIO LABORATORY

"9-ZN"

1316 Carmen Avenue. 5525 Sheridan Road. (Testing Station) CHICAGO, ILL., U. S. A.

(Continued from page 484)

that the tubes would just about stand up at this tremendous potential when tuned.

Set number 3 has the following wave-lengths 1900, 2000, 2100, 2200, 2300, 2400 and 2500 meters. When all tests were complete we called NBD at our dock in Hoboken, N. J., and after calling him twice, he came back and told us to QRX as we were jamming the Aquitania (MSU). He afterwards notified us that signals were QSA.

Since some tubes will oscillate better than others, we pickt out the two best oscillators using one as a spare in case the other burned out. We also endeavor to use tubes with nearly the same characteristics together as transmitters. This may be found roughly by trying the tubes out in the circuit in a dark room and noting the density of the greenish discharge between plate and filament and "bunching" all the tubes that give the same density together.

TUNING THE SET

We tuned our tube transmitter by setting our regenerative receiver at a point where we knew were located 2200 meters, then setting the antenna tap on what we approximately judged to be 2200 meters and then varied the oscillating circuit condenser until the set was in resonance. We then noted where we pickt up the signal and that way decided whether to increase or decrease on the taps. When the proper antenna tap was found the coupling tap was also varied until radiation was at best and again the oscillating variable condenser C2 was slightly altered.

These wave-length positions may thus be recorded or marked on the set for quick changes for future use.

It has been found that tube transmitters will draw more power when out of tune than when in tune. Therefore be careful not to hold the key down too long when tuning or you will be minus a few tubes.

It is good practice to reduce your plate voltage when tuning this transmitter until you have found the approximate position, then increase the plate voltage to normal. This reduces the strain on the tubes.

If you are using a plate voltage of no more than 400 volts, this operation will not be necessary.

POINTS ON OPERATION

The wave emitted from a tube transmitter is of practically zero decrement; when calling a station you will therefore find it quite difficult at times to raise it unless at that time it is tuning for you. To raise your man quickly we find that it is only necessary to turn your variable condenser above and below the exact resonance point. This operation swings your wave above and below the normal wave-length, so that receiving stations will hear a sharp tone passing by and will note its immediate return and naturally follow it to determine what station is wanted.

To illustrate how sharp these sets tune, for example while in Saint Nazaire, a French tube station was working two miles away and we were copying long official messages from Antwerp (360 miles distant) while on approximately the same wave-length we heard only a bubbling note from the Saint Nazaire station which did not interfere whatsoever with the weak signals we were copying from Antwerp. When we finisht with Antwerp, it was only necessary to turn our secondary condenser three degrees and St. Nazaire came in with a roar.

Incidentally and owing to our initial success, a similar set has been installed on the U. S. A. T. Northern Pacific. The same specifications employed in our set were followed exclusively.

On July 26th, at 8 P. M., we pulled out to sea carrying the Olympic teams to An-

(Continued on page 488)

A
A
C
E
E

EQUIPMENT

Dependable Efficient

Serviceable

ACE Regenerative Receiver	\$90.00
ACE Regenerative Tuner	65.00
ACE Audion Control Cabinet	22.50
ACE One Step Amplifier (Cabinet type).....	27.50
ACE Two Step Amplifier (Cabinet type).....	50.00
ACE V.T. Socket with Grid Leak.....	1.50
ACE 3 3/4" Etched Metal Dial.....	1.50
ACE 2-11-16" Hard Rubber Dial	1.50
ACE Stopping Condenser	1.00
ACE Grid Condenser75

We also carry in stock a complete line of other radio equipment such as rotary gaps, transmitting transformers and condensers, oscillation transformers, keys, kickback preventers, formica panels and tubes (any size), switches, binding posts, contacts, etc., etc.

*Your mail orders will receive our prompt attention.
Catalog free on request.*

THE PRECISION EQUIPMENT CO.

Dept. A. 2437 Gilbert Avenue Cincinnati, Ohio

"EVERYTHING IN RADIO"

WESTERN RADIO ELECTRIC COMPANY

SEND FOR OUR LATEST
STOCK BULLETIN AND PRICE LIST

550 South Flower Street Los Angeles, Cal.

A Simple Radiophone Operating on "B" Batteries

Out of our large stock of genuine double filament double life Audions we have carefully selected and tested a limited number of tubes which are especially adapted to be incorporated in a simple radiophone operating on "B" batteries of 50 to 100 volts, such as have been described in recent articles in the "R. N." and other magazines. These same tubes as is well known surpass others now on the market as detectors and oscillators for receiving purposes. Unsatisfactory tubes replaced free of charge. Price \$6.00 each.

THE KEHLER RADIO LABORATORIES, 901 W. 1st. St., Dept. R. Ailbene, Kansas

MONEY for You

Add to your Salary—Make extra Pin Money. Start a lucrative business of your own. Spend an hour each day taking subscriptions for the "Radio News." We'll pay you well and you'll enjoy the work. Write for full particulars. Circulation Dept., RADIO NEWS, 236A Fulton St. New York City.

THE ELECTRO-DYNAMIC RECEIVER

(Continued from page 434)

the weak voice currents and pass them along greatly increased in strength. How few of us realize that until these tubes were invented, transcontinental Radio was impossible, whereas now it is part of our daily life.

The vast system of transoceanic radio telegraphy was built up enabling close communication between this country and our troops abroad during the war. The success of this communication was solely due to this wonderful little piece of apparatus in its role of an amplifier, for amplifying and stepping up the infinitesimal current thrown across the water by radio stations on either side. These two uses are the more common uses of the present day development of the vacuum tube as an amplifier.

Then, having at hand this remarkable sound reproducer, and with the promise that the volume of sound emitted by the telemegafone was limited only by its input, engineers have applied the theory of the vacuum tube amplifier in such a way that when the apparatus was attached to a telemegafone, the voice, or any other small sound, was magnified to enormous volume.

With the combination amplifier and telemegafone, radio signals which are just audible can be eventually heard over a mile away. Thousands of people can hear wireless telephone talk or a large assemblage dance to wireless telephone music. Sig-

(Continued on page 496)



Send 25c for a Copy of Our Manual of Wireless Telegraphy M 12

We now have ready for distribution our Manual of Wireless Telegraphy. It contains 200 pages, fully illustrating and describing the many instruments used in Radio. 45 pages cover general instructions, diagrams, station calls, tables, codes and other information identified with the art.

The book is printed on high finished paper with a two-color cover and measures 9x5 3/4 inches.

Due to the scarcity of paper, the high cost of publication, and in order that the Manual may get into the hands of those most interested in Wireless, we ask 25 cents for it, give a coupon receipt for the amount, which coupon can be applied on a future purchase.

Get Your Copy Before the Edition Is Exhausted

MANHATTAN ELECTRICAL SUPPLY CO. INC.

17 Park Place
New York

114 S. Wells St.
Chicago

1106 Pine St.
St. Louis

604 Mission St.
San Francisco

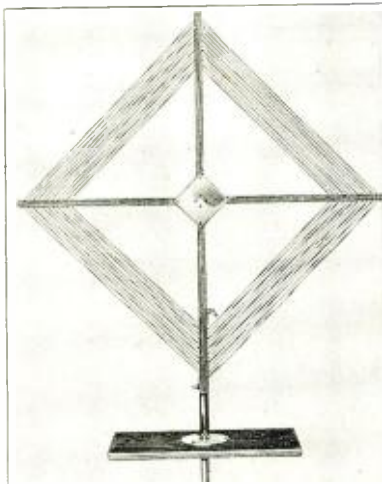

MR. CITY DWELLER

Does the landlord object to your having an antenna? Do you have heavy interference? **WELL THE ANSWER IS**

"USE A LOOP"

Our three foot loop with eleven turns, responds to a range of wave lengths from 175 to 700 meters. With two stages of audio frequency amplification local stations "COME IN" very well, while with short wave radio frequency amplification results are astonishing. In addition to its ability to cut out signals from two directions, so reducing interference it is a very accurate RADIO COMPASS. With which you may take bearings on any station you choose. This loop is well built from seasoned wood, well finished. The socket and plates are of heavy brass. We furnish the screws, binding posts, pointer and a dial graduated into degrees. Complete instructions for operating as a RADIO COMPASS STATION.

POST PAID \$5.00

CHICAGO RADIO SHOP
326 River Street Chicago, Ill.

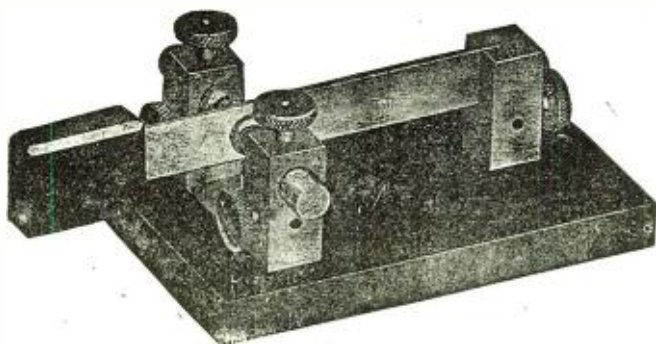

THE "COOTIE" WIRELESS KEY

A "KNOCK-EM-DEAD" BEAUTY, (as one of our customers named it) Thousands in use in every radio district. Will handle 1 K. W. satisfactorily

The "Cootie" key is the snappiest sending device offered on the market for reliable spacing of characters. Listen to 9NV, 9LU, 9MS, 9UG, 9BY, and judge for yourself. Large standards, formica knob, substantial silver contacts suitable for use up to 2KW. The double action of the "Cootie" key lends an individuality to your sending.

PRICE AT YOUR DEALER \$5.00

EXCLUSIVE REPRESENTATIVES
9th Radio District

MANHATTAN ELECTRIC SUPPLY CO.
114 Co. 5th Ave. Chicago, Ill.

6th Radio District
L. MEYBERG COMPANY
428 Market St. San Francisco, Cal.

3rd Radio District
RADIO ENGINEERING COMPANY
827 Madison Ave. Baltimore, Md.

7th Radio District
L. MEYBERG COMPANY
428 Market St. San Francisco, Cal.

5th Radio District
ROSE RADIO SUPPLY CO.
121 Camp St. New Orleans, La.

Immediate Deliveries Money-Back Guarantee



Manufacturers Jobbers Distributors of Radio Supplies

Send 4c in Stamps for Our 50 Page Catalog of Radio Supplies

(Continued from page 486)

CO-OPERATIVE RADIO BUYING

Co-operative buying brings the amateur the best in radio equipment at a saving. It also brings fast service. Send stamp for details. The following items are indicative of the varied assortment we carry. Remit these list prices and learn what co-operative buying really means.

REGENERATIVE RECEIVERS	
Grebe CR-1 with control.....	\$30.00
Grebe CR-2 170-600 meters.....	51.00
Grebe CR-3 "Relay Special".....	65.00
Grebe CR-3A with control.....	45.50
CRL Chicago Paragon.....	65.00
RA-10 Paragon.....	85.00
<i>(or build your own)</i>	
2 Variometers.....	\$15.00
1 Variocoupler.....	8.50
2 Large dials.....	3.40
6 point switch.....	1.00
6 Binding posts.....	.69
Bakelite panel 6½x16½ in.....	3.75
List price.....	\$32.25
B. BATTERIES	
Cyclone 22½ volt, small.....	\$1.25
Cyclone 22½ volt, large.....	2.40
Eveready 22½ volt, small.....	2.25
Eveready 22½ volt, large.....	3.50
Eveready 45 volt, variable.....	3.65
Eveready, 10 cells.....	3.50
CONDENSERS (Variable)	
Murdock .001 encased.....	4.75
Murdock .001 interior.....	4.25
Murdock .0005 encased.....	3.75
Murdock .0005 interior.....	3.25
Chelsea .001 encased.....	5.00
Chelsea .001 for panel.....	4.50

AUDION CONTROLS	
Grebe RORA cabinet.....	\$12.50
Acme (latest model).....	10.00
Radiocraft cabinet.....	15.00
Parkin, Tubular iron panel.....	10.00
DeForest P400 panel.....	12.00
CRL No. AD-1 cabinet.....	16.00
<i>(or build your own)</i>	
Bakelite receptacle.....	1.10
Back panel rheostat.....	1.75
2 point switch.....	.75
4 Binding posts.....	.40
1 Grid Condenser.....	.35
Bakelite panel 5½ x 5½ in.....	2.00
List price.....	\$6.35
STORAGE BATTERIES	
Marko 6 volt 20-40 amp.....	\$10.75
Marko 4 volt 20-40 amp.....	7.75
Marko 6 volt 40-60 amp.....	10.75
Marko 6 volt 40-60 amp.....	20.00
Marko 6 volt 60-80 amp.....	25.00
Marko 6 volt 80- amp.....	27.50
V.T. TUBES	
Radiotron detector.....	5.00
Radiotron amplifier.....	6.50
Moorhead detector.....	6.00
Moorhead amplifier.....	7.00
Moorhead oscillator.....	7.50
Audiotron 2 filament tube.....	6.00

"Service at a Saving" Profits shared with members.

MUTUAL PURCHASERS ASSOCIATION
Dept. J. 2 & 4 Stone Street, New York

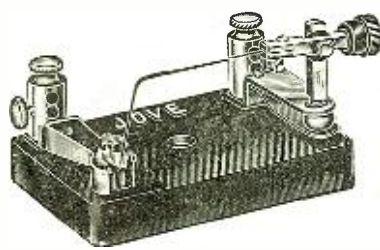

(GHEGAN PATENT)

Bunnell INSTRUMENTS
Always Reliable

JOVE DETECTOR

Handiest, Handsomest, Best
Sample by Mail, \$2.00

Tested Galena Crystal, 25c

We are distributors of the Standard Electric Novelty Co.'s Type B "Cyclone" Audion Batteries. Also of De Forest and all the leading manufacturers of High Class Wireless Apparatus. Send stamp for new edition 42RN Catalog.

J. H. BUNNELL & CO., 32 Park Place, New York

FOUR NEW BOOKS THAT EVERY "BUG" WANTS

The How and Why of Radio Apparatus
By H. W. SECOR, E. E.

This newest book on radio matters fulfills a distinct gap in wireless literature in that, while the treatment is made as understandable and as free from mathematics as possible, it at the same time incorporates a wealth of technique and instruction for the Radio Amateur—the Radio Operator—the Installation and Designing Expert—as well as teachers and students of the subject in general.

Cloth bound in Vellum de Luxe; gold stamped and hand sewed; has 160 pages. Sizes of book 6 x 9 inches.

The How and Why of Radio Apparatus. Postpaid..... **\$1.75**

A Thousand and One Formulas
By S. GERNSBACK

A Laboratory Hand Book for the Experimenter and for Everybody who wants to "do things." A Book, brimful with very important and priceless information, collected and selected for years. The recipes and formulas are classified in such a manner as to be available at once, without long research.

Besides there are a score of tables and hundreds of Illustrations and Diagrams. Book is cloth bound in Vellum de Luxe. Gold stamped and hand sewed. It contains 160 pages. The paper has been especially selected to stand rough handling in laboratories. Size 6 x 9 inches.

A Thousand and One Formulas, as described. Postpaid..... **\$1.75**

Design and Construction of Audion Amplifying Transformers

RADIO AND AUDIO FREQUENCY TYPE

This latest and important book by Mr. Edward T. Jones, late Associate Editor of Radio News, will be of great interest to all radio amateurs throughout the land. The transformers shown in these books have never been described in print before, and have usually been considered a manufacturer's secret. Anyone who has several vacuum tubes cannot afford to do without this book because it will enable him to build the necessary amplifying transformers very readily.

The book is printed on good paper and has an attractive cover in two colors. Paper bound. Size 5 in. x 7 in. Contains many illustrations, diagrams and working data necessary to build the transformers.

Price, Postpaid..... **25c**

Wireless Course in 20 Lessons

By S. GERNSBACK, A. LESCARBOURA and H. W. SECOR, E. E.

A course that tells you everything you want to know about "Wireless," starting off in lesson No. 1 by explaining the Principles of Electricity. By simple, easy stages, this wonderful Course takes you into "Wireless" by the use of such simple language so skillfully used that of necessity you must understand every word. There is a whole lesson devoted to the Theory and Mathematics of this epoch-making subject. The last lesson is devoted to a history of Wireless.

More than 50,000 of this course sold
Eighth Edition

Size of book is 7 x 10¼ in., 160 pages, 350 illustrations, 90 tables.

Flexible cloth cover, per copy..... **75c**

Stiff cloth cover, per copy Postpaid..... **\$1.25**

Order direct or for sale at leading dealers.

EXPERIMENTER PUB. CO., Book Dept. 236a Fulton St., N. Y. C.

Accompanying them were ten newspaper reporters, who had all manner of press reports to send. An average of fifteen hundred words per day was therefore given us at 6 P. M., outside of our regular traffic, for transmission to the Associated Press, Universal News Service, the New York Evening Post, the New York Telegram, the Boston Post, the Chicago Tribune and the Army Publicity Bureau. We are proud to say that we never lost communication all the way across and that all our messages reached their destinations in time for the press. We worked Bar Harbor a considerable number of miles east of Cape Race in daylight. When we lost NBD we made arrangements with the manager of the Cape Race station by radio to stand by us for fifteen hundred words each night. The Cape Race station held us every night until we were within 150 miles of Lands End, England; from then on we routed our traffic via England.

On our return trip we had the Boy Scouts on board who had just completed a tour of Europe and consequently we handled considerable traffic for them.

While in mid-ocean (NSS) Annapolis notified us after his press schedule to get in touch with Bar Harbor (NBD) as soon as possible.

When we were 250 miles east of Cape Race (VCE) at 10 A. M., we succeeded in raising (NBD) Bar Harbor on our tube transmitter, a distance of about 1000 miles. He stated that our signals were weak but readable thru the light static. We then gave him 48 messages without trouble and later in the day we transmitted 30 more. NBD was elated over our success and wished to know if we would relay for other ships. When we were not busy we gladly relayed for a number of ships to NBD and also forwarded traffic from NBD to them. This practice is now general and a good number of ships daily give us their TR's and traffic for NBD.

FUTURE POSSIBILITIES

Radio service today could be greatly improved if all heavy traffic ships were equipt to work on undamp wave. This would permit these ships to clear their traffic on undamp and would give the other ships not so well equipt a better chance to clear their traffic on 600 meters, thus greatly reducing (QRM) interference.

At present there are only two stations standing by for undamp wave vessels; these stations are (NBD) Bar Harbor and (GKU) Devizes, England. Bar Harbor answers on spark (2000 to 2400 meters.) Devizes employs a tube transmitter on a wavelength of 2200 meters.

Tube transmitters are in their infancy and great results are in store for this type of transmission. When with only a radiation of 2 to 2½ amperes, it is possible to work 1000 miles in daylight, what distance could be covered if these sets were more powerful and radiated from 15 to 20 amperes? I dare say it would be possible to work across the ocean providing conditions were satisfactory. Possibly in the near future a transatlantic high power station will be a vacuum tube transmitter radiating from 30 to 40 amperes instead of the 500 KW arc now used.

TOO BAD!

Radio Bug: "I couldn't work on my aerial all day"

Condenser: "Why?"

Radio Bug: "Every time I looked at the three ball insulators on each wire I thot of my watch and overcoat."

CARLEY CONNOR.

A.C. FOR V.T. FILAMENT

(Continued from page 447)

wire aerial 30 ft. high and 80 ft. long.
The transformer may be of the bell ringing type with a 4 to 6 volt secondary, or can be constructed according to the following data:

"Size laminations 7 cm. x 2 cm. x 12 mils thick, 250 are required, and can be conveniently cut from two four-gallon size benzine tins. The laminations must be annealed to burn off the tin coating and then varnished.

"Former wind the primary and secondary using for the primary 2,500 turns, No. 26 B. & S. enamel for 220 volt, 60 ~ or 1,200 turns No. 22 B. & S. enamel for 110 volts. The secondary is wound with No. 16 B. & S. double cotton wire.

"The resistance of the potentiometer is immaterial and may be anywhere between 25 to 1,000 ω .

"Using this system in conjunction with the B battery described in a previous issue of RADIO NEWS, I am quite independent of the battery service station profiteers. Now then all you Hams—"Go thou and do likewise."

*During the reconstruction period
the untrained man is the first
affected—the first to be laid off—*

Become A Trained Man!

let us train you for the wireless service. Permanent positions in land stations, and rare opportunity at sea in our constantly increasing merchant marine. Splendid salary from \$40 to \$50 per week as an officer. Opportunity for foreign travel. See the world under first-class conditions.

Results and positions guaranteed by the best equipped Radio School in New England. Two separate theory courses in both Day and Evening sessions, advanced and elementary. During a recent month nine of our graduates made an average of 83% out of a possible 90% in government examinations.

*Students may enter at any
time. Send for free literature.*

MASSACHUSETTS RADIO and TELEGRAPH SCHOOL
Boylston Street, Tel. Beach 7168 Boston, Mass.

*There has been a telegraph school at 18
Boylston Street for over eighteen years.*

R. F. TROP

G. R. ENTWISTLE

FADA Audion Panel—the Panel with the Automatic Filament Control

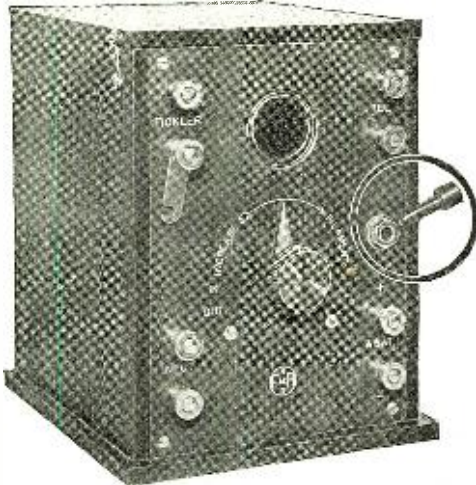

See that plug? After you're all tuned up,—you can leave your set,—all ready to go right ahead when you come back, simply by disconnecting that control plug. It's features like this that distinguish FADA apparatus, built and designed under the personal direction of Frank A. D. Andrea, the outstanding instrument maker of the U. S. Every radio instrument, before it leaves the FADA shops, must meet these standards:

Genuine Grade XX Hand Grained, milled edge panels:
Quartered oak, hand rubbed. Weathered finish cabinets with hinged top for inspection.
NO moulded parts.
Hard drawn nickel plated copper bus-bar wiring.
Exposed parts hand buffed and polished nickel.
Workmanship by instrument makers, not shoemakers.

CONTROL PANEL
(As illustrated)
Automatic Filament Control.
Grid-Leak-Condenser
Tickler Connections
Cabinet for "B" Battery,
\$17.50
Dimensions 7 $\frac{1}{2}$ "x5 $\frac{1}{2}$ "x5 $\frac{1}{2}$ "

TWO STAGE AMPLIFIER
Telephone Jacks
Automatic Filament Control
NO Howling—Real Amplification
\$50.00

IN STOCK AT
H. I. Sackett, Buffalo.
Radio Electric Co., Pittsburg.
American Electro Technical Appliance Co., New York City.
Northwest Radio Co., Seattle.
Manhattan Electrical Supply Co., New York City.
Continental Radio and Electric Corp., New York City.
General Apparatus Co., 570 West 184th St., New York City.

Personal Note to Progressive Dealers—All FADA Apparatus is designed, built and distributed by my personal organization only. A clean cut plan of buying direct from me at lowest prices. Profitable discounts, shipments on time, personal attention to each order.

Frank A. D. Andrea, 1882 Jerome Ave. New York City

To the Radio Experimenter:

For four years, constantly watching the American Radio Experimenter from the vantage point of the Radio Editor's desk at Everyday Engineering Magazine, I have tried to discover the ways in which a radio apparatus and supply company can best serve the Experimenters.

Going back of small details, the big want was clearly a company which understood the need of a spirit of friendliness, helpfulness, and courtesy toward radio men.

When, a month ago, I acquired a controlling interest in the G. A. plans were laid to make the G. A. just such a company. From now on, it will be my work to make every Experimenter say to himself. "I can depend upon the G. A."

M. B. SLEEPER,
President
The General Apparatus Company, Inc.

- | | | |
|--------------------|---|---------|
| SOCKETS | ACE Sockets are handy to mount, well made, and the choice of most men. | \$ 1.50 |
| RA-Ten | A REGENERATIVE Set for the man who wants to make no mistakes. | 85.00 |
| CHELSEA | Condensers are made for panel mountings 0.0006 mfd., \$4.00, 0.001 mfd., | 4.50 |
| INDUCTANCE | TABLES show you quickly the inductance of any size coil. | .25 |
| P BATTERIES | PLATE batteries, G. A. make, 22.5 volts, Signal Corps, \$1.25. Navy | 2.00 |
| AMPLIFYING | Transformers, new design Federal type, a big improvement | 7.50 |
| DETECTOR | G.A. LABORATORY type, audion control, simply made of best materials | 5.95 |
| AMPLIFIER | G.A. LABORATORY type, like above, with new Federal transformer | 13.95 |
| PHONES | BALDWIN'S are becoming so popular that you can't very well get along without them | 20.00 |
| BAKELITE | SPECIAL Sale of panels 5x5x3/16 inches. Dead true and square. Now | .60 |
| G L C | G.A. GRID LEAK CONDENSER for your tube instead of the expensive types. The same or better results | .50 |



The General Apparatus Company, Inc.
570 N. West 184th Street New York

ATTENTION AMATEURS

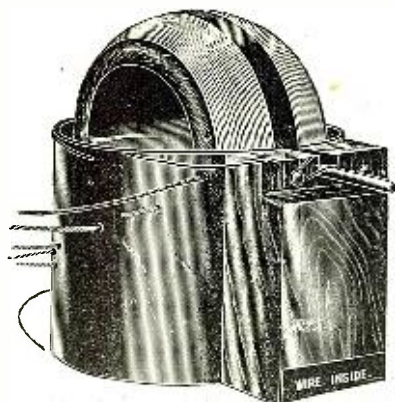

Why pay \$65.00 for a Short Wave set when you can buy the parts and make up your own for half the price?

This vario-coupler is compact and easy to mount. Primary wire is wound on the inside of the tube thereby giving greater inductive value.

Price - - \$5.00
Variometer - - \$4.50

We sell anything in radio apparatus. Watch for announcement in next issue.

Write for Catalogue N-15.

DAVID KILLOCH COMPANY
57 Murray Street - New York, N. Y.

I Want To Know

(Continued from page 462)

speech by radiofone when properly adjusted.

LOOP AERIAL

(150) Skriver Nielsen, Minden, Nebraska, asks the following:

Q. 1. How many turns of wire must be wound on a frame, for a loop aerial receiving signals from 200 up to 600 meters?

A. 1. A four foot square loop wound with 6 turns spaced 1½ inches apart is quite suitable for the reception of these wavelengths. A tap should be taken at the third turn for the reception on 200 meters.

Q. 2. Is a loop aerial connected up with an audion circuit in the same manner as the secondary of a loose coupler?

A. 2. Yes, the connections are the same but we suggest that you use the circuit described for question 141, a diagram of which appears in this number.

Q. 3. Would an audion detector be sensitive enough to pick up signals from stations 600 miles away using a loop aerial 5 feet square?

A. 3. It may be possible under good conditions to receive from such a distance providing the sending station is powerful enough. The use of a regenerative circuit would help greatly, and it is certainly possible by using one or more stages of amplification.

T AERIAL

(151) John P. Hale, North Adelaide, S. Australia, wants to know:

Q. 1. Would the general efficiency of a T aerial be reduced if the lead-in from the center did not come straight down but ran obliquely to the receiving set?

A. 1. No, this does not affect the efficiency of the aerial.

STRANDED AERIAL WIRE

(152) Fred L. Woolsey, San Francisco, Cal., asks:

Q. 1. Is it possible to make a good umbrella type aerial by using several No. 30 copper wires twisted together, and if it is possible would it be as efficient as using ordinary phosphor-bronze wire?

A. 1. Certainly, an antenna built in this manner would be very efficient as the greater surface of the wires would present less high frequency resistance to the incoming waves.

RADIO MAP

(153) Raymond Pfisterer, Evansville, Ind., asks:

Q. 1. Where can I obtain a map locating all the Government Radio Stations?

A. 1. We suggest that you write to our book dept., which publishes such a map. The price is 10c.

BAKELITE

(154) R. S. Walker, Reno, Nevada, asks the following information:

Q. 1. Which is the hardest material to saw and drill thru—bakelite, hard rubber or formica?

A. 1. The formica is the hardest material to work with, then bakelite, and hard rubber is the softest. For amateur work bakelite and hard rubber are the best to use.

HONEYCOMB COIL

(155) Charles Moore, Kenton, Ohio, wants to know:

Q. 1. What is the exact wave-length of an L 25 De Forest honeycomb coil shunted by a .001 mfd. variable condenser, this circuit being used for a wavemeter?



PARAGON RHEOSTAT

\$1.75 POST PAID

For back of panel or table mounting, 2½ in. dia., 6 ohms, 1½ amps.

De Forest CV500A Variable Condenser (No knob or pointer). A few left, at \$4.00

\$10 General Radio Hot Wire Ammeters (flush type) \$7.75

AUDIOTRON ADAPTOR

Consists of standard 4-prong base with brass supporting connectors; permits mounting tube in vertical position so filament will not sag and touch grid.

\$1.75 Postpaid

Improved Standard VT Socket, \$1 Electron Relay (Improved), \$5 A-P Amplifier VT (SB 1444), \$5

44 VOLT VARIABLE B BATTERY

\$3.60

(Plus Postage on 4 lbs.) Complete in handy wooden case with adjustable phosphor bronze "Jiffy" Connectors. Better than block batteries. If one 4.4 volt unit weakens prematurely, it can be removed and replaced, thereby not impairing the total voltage—making this the best battery value on the market; fresh 4.4V renewal units always in stock.

40c each, or \$3.10 per 10, plus 4 lbs. postage



ANTENNA WIRE 1c PER FOOT

7 strands, No. 22 copper, tinned to prevent corrosion. Include Postage on 15 lbs. per 100 ft.

- Lightning Switch, 100 amp., 600 volt. \$4.00
- Young & McCombs Rotary Gap. 16.00
- Side Action "Cootie" Key, ½ KW. N.P. 5.00
- Mesco Standard Wireless Key 2.50
- Chelsea Oscillator 3.00
- Chelsea Grid Leak 3.00

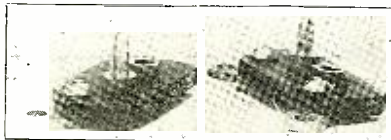

HONEYCOMB COIL ADAPTORS

\$1.50 PER PAIR

Attach to binding posts of a Murdoch Variable Condenser—insert H-C Coil—making a Tuning Unit. Two Units make a Loose Couple, a third makes a Tickler Coil. One makes a first class Wavemeter.

RADIO EQUIPMENT CO., 630 WASHINGTON ST. BOSTON, 11, MASS.
— 4th FLOOR —

USE A CHELSEA OSCILLATOR



PRICE \$3.00

For undamped reception on long wavelengths. Oscillates on 3,500 to 20,000 meters. Eliminates tickler coils. Simplifies tuning. Is inexpensive.

Consists of two feed back and one grid mica dielectric mica condensers enclosed in bakelite base.

WE STAND BACK OF EVERY PRODUCT WE DISTRIBUTE AND GUARANTEE SATISFACTION

PROMPT ATTENTION GIVEN ALL ORDERS AND INQUIRIES

DOUBLEDAY-HILL ELECTRIC CO.

RADIO DEPT.—DESK 13

715-12th St., N. W. Washington, D. C. 719-21 Liberty Ave., Pittsburgh, Pa.

A. 1. The natural wave-length of such a circuit is from 130 to 375 meters.

Q. 2. What range of wave-length is obtained with an L 50 coil substituted for the L 25 coil in the circuit described above?

A. 2. The range of wave-length obtained with an L 50 coil will be from 240 to 730 meters.

RADIO QUESTIONS

(156) Howard Toft, Perth Amboy, N. J., would like to know:

Q. 1. In which back issue of RADIO NEWS can I find the data for a radiofone using an audiotron?

A. 1. Data for such a radiofone was published in the September, 1920, issue of this magazine.

Q. 2. What size of wire should be used for a loop aerial?

A. 2. No. 20 copper wire will give very good results for this purpose.

Q. 3. Can you tell me when the high power station NFF sends?

A. 3. We do not know the schedule of NFF for this station is owned by the Navy Department.

RADIO AND AUDIO FREQUENCY TRANSFORMERS

(157) Eugene M. Link, Camp Knox, Ky., requests the following information:

Q. 1. Can audio frequency transformers be used to amplify at radio frequency?

A. 1. No, the winding of audio frequency transformers is not suitable for amplification of high frequency oscillation, the impedance of the circuit being too great.

Q. 2. Where can I obtain data for the construction of a radio frequency transformer?

A. 2. For complete information on this subject we refer you to the book "Design and Construction of Amplifying Transformers," by E. T. Jones, publish by the Experimenter Publishing Co., price 25c.

THE MILWAUKEE AMATEURS' RADIO CLUB

(Continued from page 456)

waukee. The room is located on the sixth floor of the Old Insurance Building, 373 Broadway. As usual the meetings are held weekly but on Monday evenings at 8 o'clock instead of Thursday as in the past. Of late the meetings have been devoted to discussions of QRM and its mitigation. The membership arrived at the conclusion that the best thing to do was to adopt the "Chicago Plan" of control of radio traffic. The rules that have been adopted are being enforced and a noticeable improvement in traffic conditions has been the result. Thru the various committees of the club it is expected to have something of interest given at each meeting.

The club wants every radio amateur in Milwaukee to become a member of the organization and an invitation is extended to all interested persons to attend the next meeting. Come down and talk to the secretary. He will tell you about the club and give you an application blank. The financial obligations of membership are small in comparison to the benefits derived.

It was proposed some time ago to hold a Wisconsin State Radio Convention, but to date little has been done because the Club was not in actual contact with other local radio clubs and radio amateurs outside the city. At this convention it has been proposed to hold the first general meeting of this newly proposed Wisconsin association and, further, it will be under the auspices of this Wisconsin Association that the convention will be held each year. About the first of next March is that to be the logical time for such a convention as it is hoped by that time the club will be in touch with all other local radio clubs as well as local State members of the proposed Wisconsin Association.

The officers of the Milwaukee Amateurs' Radio Club for this year are as follows: L. S. Baird, Chairman of the Board of Directors; C. N. Crapo, President; Louis Heyman, Secretary; E. W. Ruppenthal, Treasurer. Besides the Committee on Interference and Relay there are Committees on Membership and Affiliation, Research and Development, Papers and Publications, and Publicity. Thru these committees the actual work of the club is done.

Address all club communications to the office of the president, 601 Enterprise Building, Milwaukee, Wisconsin.

These coils with the new Turney Circuit produce much greater amplification.

Actual Size

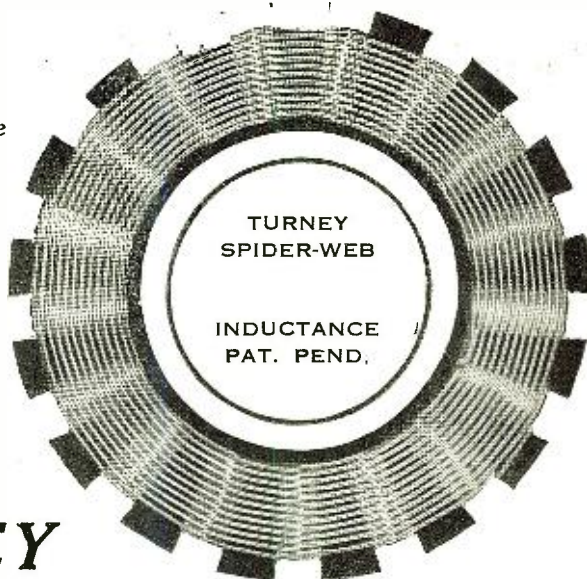

TURNEY SPIDER-WEB INDUCTANCE COILS

Built at Radio Hill—

UP AT the foot of the Berkshires, amid inspiring surroundings, nestles Radio Hill. This ideal radio location is the scene of the development of the Turney Spider-web Inductance Coils. Here, far from any outside influence, Eugene T. Turney, *Radio Engineer*, the man who developed the Crystal Detector, has brought forth a sensational improvement in machine wound coils.

Below is shown the Turney complete receiving unit. It contains three Spider-Web Coils, the secondary and tickler being adjustable to the primary. The doors are capable of exceedingly fine adjustment. Six Binding posts allow for almost any type of circuit. With two condensers, of .0005 m.f., this unit will respond to wave-lengths of 175 to 400 meters. The results will give you a new idea of radio efficiency.

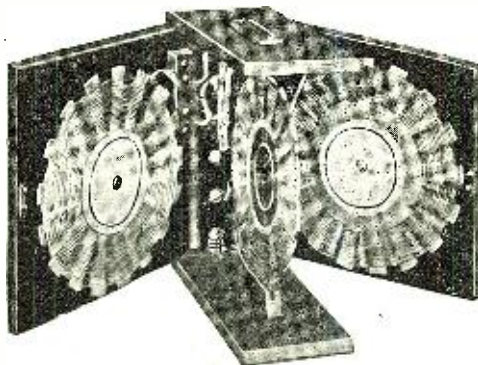

Illustration shows front of cabinet removed Formica Insulation Thru'out Patent Pending Dimensions, 4 1/2 x 5 x 1 3/4

PRICE SIX DOLLARS COMPLETE

Order direct from this advertisement. Send check or money order for \$6.00 plus postage, and your Spider Web Unit will come forward at once. OR write us for circular, explaining the Spider Web principle in detail.

THE WINDING

showing angle at crossing. This style of winding has four distinct and exclusive advantages.

- MORE INDUCTANCE**—There is no magnetic leakage in coupling. The coils are flat, and the entire magnetic area is available.
- LESS DISTRIBUTED CAPACITY**. The wire runs parallel for a greater distance, and crosses itself less frequently than in any other coil known.
- LOWER HIGH FREQUENCY RESISTANCE**. There being no interior magnetic field, or air core, high frequency resistance is reduced to a minimum.
- OCCUPIES LESS SPACE**. The coils are so thin that three of them are less than 3/4 inch in width.

Eugene T. Turney Laboratories, Inc.
RADIO HILL, HOLMES, NEW YORK

Progressive dealers are invited to write for our interesting sales offer on Turney Complete Receiving Units.

There's a Copy waiting for you—



Be sure to get the American Electro Technical Appliance Co.'s new 84-page catalogue—*just off the press*. The stock listed include every radio instrument you could possibly want. The prices show the big savings of our low rents, low expense and big sales. The accuracy and promptness of our mail order department is the result of many years' experience in filling every need of the up-to-date radio man.

Send for your copy of our wonderful new catalogue *to-day*. The last edition was exhausted before we could supply half the requests. Get your copy of the new edition right away. To cover mailing and postage, please enclose ten cents, stamps or coin. We'll mail your catalogue, the day we get your request.

American Electro Technical Appliance Co.
 235 Fulton St. Dept. E New York

MASTER WIRELESS APPARATUS MADE RIGHT PRICED RIGHT

The Apparatus Supreme. Designed by Leading Radio Engineers, made by Expert Electricians, in a REAL Factory, at prices that are within the reach of ALL, while our SERVICE is the BEST in the Country on all Apparatus. The Monthly Bulletins will save you money.

A Catalog That is Different

It's a wonderful book for the REAL Experimenter, full of photographs, bargains and surprises and shows a complete line of WIRELESS INSTRUMENTS, SCIENTIFIC APPARATUS, CHEMICALS, LABORATORIES, GLASSWARE, Etc. Edition Limited. Send 12 cents (refunded on \$1.50 order) for YOUR copy TO-DAY. We handle a complete line of Apparatus made by the leading Manufacturers. Service, Quality and Satisfaction or your money back.

PALMERS ELECTRICAL EQUIPMENT CO.
 Palmers, Minn.

We Pay All Shipping Charges. We Are As Near As Your Mail Box.

Our New Bulletins No. 4 & 5, Now Ready!

It Costs But 4c to Get Acquainted With Sorala Quality, Price, and Service.

TYPE J METERS are rugged, accurate and of refined appearance. Movement D.C. Moving coil D'Arsonval type. The price is not an index of their intrinsic value. Standard ranges, 0-100, 0-300 and 0-500 Milli-amps, and 0-3, or 0-5 amps.
 Price \$7 Postpaid

GENERAL RADIO, Type 127A Hot Wire Ammeters used as Radiation meters and in A.C. Filament Circuits.
 New Price, \$7.75 Postpaid
 Ranges 0-½, 0-1, 0-2½ and 0-5 Amps.

SOMERVILLE RADIO LABORATORY
Have You Noticed Our Phenominal Growth?

SORALA SPLIT-SECONDARY Modulation Transformer, \$6.00 P. P. Permits simultaneous modulation of both grid and plate circuits and maximum voice effectiveness with all tubes used as oscillators. See page 285, November Radio News.

Special Radio Microphone Transmitter with Nickered Bracket, \$4.50 Postpaid

SORALA S-10 BAKELITE VT SOCKET \$1.10

TYPE CSU Variable Condenser } .0006 mfd. . . \$6.00
 } .0011 mfd. . . \$6.50

DISTRIBUTORS OF SORALA SERVICE
 102 Heath St., SOMERVILLE, MASS.

There's a Reason! Send Us Your Order.

Bound Volume No. 1, Radio Amateur News, 12 issues, July, 1919—June, 1920. Attractively Bound. Only \$2.00 plus postage. A most valuable asset to your library. Order today.

An Efficient Wave-Meter

(Continued from page 435)

ductance coil, will suffice to operate the buzzer, and a push button, mounted on the top of the case (see photo 1) will be used to control the buzzer. This will complete the transmitting end of the wave-meter.

A permanently adjusted galena detector may prove very satisfactory for receiving. An easily made one may be built as follows: place a small cat-whisker detector in a cardboard box. Find a sensitive spot on the galena and then drop candle wax around it until the box is filled. This imbeds the detector in wax and makes it keep its adjustment. Bring out leads thru the lid of the box and mount the detector underneath the top of the wave-meter case (as shown in Fig. 2). Two binding posts must be provided on the top of the case, to which is connected a pair of fones. A small double pole double throw switch is mounted on the top of the case to change from sending to receiving, as can be seen in the diagram. This switch is visible on the photo, Fig. 1.

If it is desired to measure waves shorter or longer than the range of the above described instrument the following results can be obtained by changing the capacities and inductances as follows:

With a No. 368 Murdock variable condenser (max. cap., .0005 mfd.) and an inductance consisting of 22 turns of No. 16 B. & S. gage S. S. C. wire wound closely on a drum 6½ inches in diameter the following readings will be obtained:

Condenser Degrees	Wave-length
0	140
10	160
20	195
30	235
40	260
60	300
80	340
100	365
120	400
140	440
160	470
180	500

Or if longer waves are desired use the following:

Condenser—Mesco variable No. 294 (max. cap., .001 mfd.).

Inductance—146 turns of No. 16 B. & S. gage S. S. C. wire wound closely on a drum 6½ inches in diameter.

The readings are as follows:

Condenser Degrees	Wave-length
10	610
20	845
30	1040
40	1230
50	1400
60	1570
70	1660
80	1780
90	1875
100	2000
110	2100
120	2170
130	2285
140	2350
150	2410
160	2495
170	2505
180	2650

It will be noted that all inductance is straight wound in a single layer which gives better results and more accurate readings than any other system of winding.

A POOR CONNECTION

Smith: "They say their divorce was the logical result of being married by wireless."

Jones: "How's that?"
 Smith: "One of the stations used a loose-coupler."
 —A. H. FLURY.

High and Low Spark Notes for Amateur Transmitting

(Continued from page 450)

mer system would have a considerably greater range than a station using the higher frequency. The important thing then, is not the power per second radiated from an antenna, but the power per wave train, within limits which will be outlined below, and the "sending current" which will determine the range of the station depends in no way upon the hot-wire ammeter reading.

The next thing to consider in connection with the number of wave trains or spark frequency to be used is the effect on the receiver of various incoming spark frequencies. Refer again to Fig. 1. If the incoming frequency happened to be 990 cycles per second, the sound produced would be 625 times as great as if the incoming frequency were 450 cycles, or 2,410 times as great as for 110 cycles, provided the wave trains had the same amplitude. (The sound intensity varies as the square of the amplitude of movement of the diaphragm.) If the incoming frequency were 900 cycles per second, the sound would be 3² times the 450-cycle sound, or 5² times the 110-cycle sound. But with the 110-cycle frequency, each wave train would contain 8.2 times as much power as the wave trains for the 900-cycle frequency for the same power radiated, so after equalizing the radiated power the new 110-cycle signal would be 67 times louder than the original one, or nearly three times as loud as the 900-cycle signal. (Sound intensity varies as the fourth power of the current in the wave train.)

The above still assumes that the current exciting the telephone has a sine wave form. The telephone exciting current from incoming spark signals can be approximately represented by drawing a line thru the peaks of all the oscillations in the damp wave train. Fig. 4 shows the telephone current thus constructed and drawn to a scale for a frequency of 110 cycles per second. In order to show the wave trains at all they have to be drawn as taking up ten times as much space along the time axis (horizontal one) as they actually do. Over the telephone, current is the dotted line representing a sine wave of the same frequency and amplitude. It is at once apparent that the telephone current differs widely from the dotted curve and seems to consist more of a series of short pulses than of a continuous current; and on this account its effect on the telephone at the resonant frequency of 990 cycles per second will not be as great as Fig. 1 would indicate. The effect at the other frequencies would be somewhat the same as is produced by sparks in impact excitation transmitters, and the effect on the diaphragm would be greater than Fig. 1 shows. In fact, it is doubtful if the 990-cycle amplitude would be more than nine or ten times greater than the 110-cycle one, and the whole curve would be flattened, with the result that the sound from the 110-cycle note would be still greater in comparison with that from the 900-cycle one. However, the ear is more sensitive to the higher frequency and in this particular case where all the wave trains of the 900-cycle frequency have the same amplitude, the high note would probably seem to be louder, altho the low note would actually contain more energy.

The impossibility, from a practical point of view, of transmitting at a spark frequency corresponding to the resonant frequency of the fones at the receiving station, is apparent. Fones used by amateurs include mica diaphragms—Murdocks, Brandes, Western Electrics (for those who

(Continued on page 494)

The Corwin Mail Order Service

Progressive amateurs certainly encourage a good mail order service! We were astonished, ourselves, at the numbers who responded immediately to our first announcement of the Corwin Radio Service. Every day hundreds more are complimenting us on our large stocks, low prices, courteous attention, plus shipments the same day we receive the order.

If you are one of those who have not yet found out about our service, order direct from the list below, or send ten cents for our complete catalogue, to-day.

VARIABLE CONDENSERS		VACUUM TUBES	
A. R. Co., .001	\$6.25	Electron Relay	6.00
A. R. Co., .0005	5.00	VT Amplifier, 1 lb.	7.00
With No. 67 Dial, add \$1.00.		VT Extra Hard	7.50
Murdock 366	4.75	ROTARY SWITCHES	
Murdock 367	4.75	Clapp-Eastham, No. 19	1.00
Murdock 368	3.75	Clapp-Eastham, No. 19A35
Clapp-Eastham 800	7.50	Our Own, No. 140
Clapp-Eastham 800A	9.50	Our Own, No. 255
Clapp-Eastham 800E	11.50	Postage 5 cents.	
Complete with dial. Shipping weight one pound.		CORWIN DIALS	
GRID CONDENSERS		No. 66, 3 in.75
Radisco, postage 3c35	No. 67, 3 in., with knob.	1.30
ANTENNA SWITCHES		No. 68, 3 1/2 in.	1.00
Murdock, 3 pounds	4.50	No. 69, 3 1/2 in., with knob.	1.70
Clapp-Eastham, 10 pounds	12.50	Postpaid.	
OSCILLATION TRANSFORMERS		RECEIVERS	
Radisco, No. 5	15.00	Murdock, No. 55, 2000 ohm.	4.50
Via express, collect only.		Murdock, No. 55, 3000 ohm.	5.50
RADIO CRAFT PRODUCTS		Brandes Superior	7.00
Detector	15.00	Baldwin C	16.50
Two-Step Amplifier	50.00	Baldwin B, Improved	20.00
Detector and One Step	45.00	Brownlie New	12.00
Detector and Two Step	70.00	Shipping weight, 2 lbs.	
Postage paid.		CONTACT POINTS	
"B" BATTERIES		CP—No. 1, brass, dozen25
Radisco, No. 1, 2 lbs.	1.50	CP—No. 4, brass, dozen35
Radisco, No. 5, 5 lbs.	2.65	CP—No. 5, nickel plated45
Eveready Storage Battery prices on application.		Postpaid.	
TUSKA C.W. APPARATUS		VARIOMETERS	
181 Coil, 2 lbs.	7.50	Radisco, No. 1	7.50
182 Coil, 2 lbs.	10.00	Radisco, No. 1D	8.75
183 Coil, 3 lbs.	12.50	3 pounds.	
170 Phil., 8 lbs.	16.00	VARIO-COUPLER	
AERIAL WIRE		Radisco No. 2	8.50
7x22 Tinned Copper.		Radisco No. 2D	9.50
100 feet, 2 lbs.	1.25	3 pounds.	
200 feet, 4 lbs.	2.40	LOOSE COUPLERS	
500 feet, 8 lbs.	6.00	Clapp-Eastham Radion	14.00
AMPLIFYING TRANSFORMERS		Murdock, 344	9.00
A. R. Co., 1 lb.	5.00	6 pounds.	
Federal, 1 lb.	7.50	GROUND OUTFIT	
JACKS AND PLUGS		Consists of SPDT 500 Amp. Switch, 25 feet No. 4 Wire, Clamp and Cleats, pre-paid	7.00
Federal Closed Circuit85	VT SOCKETS	
Federal Open Circuit70	Murdock	1.00
Federal Double Circuit	1.00	Radio Service Double	3.00
Federal Plug	2.00	Radio Service Triple	4.00
Postpaid.		Shipping weight 1 pound.	
ALL RADISCO COILS and Wireless Press Books.			

All orders for apparatus not listed as postpaid must be accompanied by postage charges.

SEND TEN CENTS FOR CATALOG

A. H. CORWIN & COMPANY

Dept. B2, 4 West Park Street,

Newark, New Jersey.

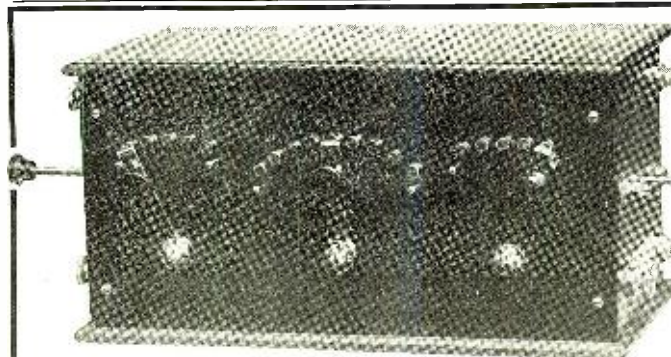

HERE IT IS, BOYS!

This New short Wave Tuner brings in 200 to 600 meter stations clear as a whistle. Just the thing for Radio

phone work. It has variable primary, secondary and wing circuits. Finished in quartered oak and hard-rubber panel. Absolutely the finest and best tuner obtainable. Send 2-cent stamp for new bulletins.

COLBY'S TELEGRAPH SCHOOL

AUBURN, N. Y.



THE "ILLINOIS" VARIABLE CONDENSER
 The Condenser with "Star Spring" Tension
MADE RIGHT - STAYS RIGHT
 Hard Rolled Aluminum Plates

These condensers are made by a watch mechanic schooled in accurate workmanship and who can't get over the habit of critical inspection.

Three Styles; No. 1, Panel; No. 2, Open Type as shown; No. 3, Fully Encased. Anti-Profitteer. Less than pre-war prices. Fully assembled and tested.

Style No.	No. 1	No. 2	No. 3	
67 Plates	\$7.00	\$	\$	Money back if not satisfied.
43 "	3.50	4.50	4.75	Just return condenser within 10 days by insured Parcel Post.
23 "	2.75	3.75	4.00	
13 "	2.25	3.25	3.50	

With Style No. 1, we will, if desired, furnish 3 inch Dial with large knob, instead of Scale and Pointer.

Extra Price 75 cents.

Sent Prepaid on Receipt of Price.

Except: Pacific States, Alaska, Hawaii, Philippines and Canal Zone, add 10c. Canada add 25c.

Foreign Orders other than Canada not solicited.

The "ILLINOIS" is rapidly adding to the number of its friends. The bouquets they fling only spur us to still more careful work, and more rigid inspection. It is a matter of pride that among the thousands of instruments sent out, not a single complaint has been received of bad condition. This may possibly be because every instrument is subjected to the scrutiny of the "old man's" eyeglass.

Patent is pending on the "Star Spring" feature, which is very valuable. The action of this spring produces an unvarying friction that holds the "rotor" in any position to which it may be set, and at the same time automatically centers the plates in relation to each other, and prevents any possibility of "endshake."

The plates are in proper relation by construction, and will remain so, obviating any necessity of readjustment. Once right, always right. Once mounted on your panel, there is one thing that you can depend upon to never give you trouble.

We thank our friends for their letters of generous appreciation.

Kindly note: We issue no Catalog, and make no "trade discounts." We set our prices at the lowest limit, and leave the "middle man" out for the sole benefit of the "consumer."

G. F. JOHNSON

625 Black Ave. Springfield, Ill.

have been in the army or navy) and many others, and each make of receiver has a different sized diaphragm, and hence, different natural frequency from the others. The resonance curves are so sharp that no overlapping can be counted on and it is for this reason that the frequency of 900 cycles instead of the resonant frequency of 990 cycles was chosen in the above examples for illustration. This would be about as near as it would be possible to get to resonance in practice unless the owner of the transmitting station had a frequency meter.

So far it has been assumed that it was possible for an amateur station to send out 900 wave trains per second and have the same amplitude for each one. A non-synchronous rotary spark gap, operated on a 60-cycle current, will not do this. Fig. 5 represents a 60-cycle current and the little dots show the places at which the spark will have to jump in order to get 900 sparks per second. The dots at the lowest places represent voltages that are only two tenths of the maximum. The energy in a wave train is equal to $\frac{1}{2}CE^2$. Therefore, the wave trains corresponding to the low value dots will contain only $\frac{4}{100}$ as much energy and $\frac{4}{100}$ as much power as those corresponding to the maximum voltage values. The main work of transmission must therefore be done by the wave trains containing the most power, and at a short distance from the transmitting station the smaller wave trains become inaudible, resulting in a rough, rather disagreeable note being received. The dotted line in Fig. 6 shows the approximate variations in the wave train amplitude during one cycle. For the sake of clearness, only a few of the wave trains have been shown, and these are not drawn to scale. The variations in this dotted curve correspond to the variation in the 60-cycle current and it appears from the figure that a 120-cycle note will be superimposed on the transmitted note of the non-synchronous rotary. This is well borne out in practice and can always be detected in high note amateur transmitters.

Another factor tending to make the note of the non-synchronous rotary rough, is that there will not be equal intervals of time between all sparks, even when the studs on the rotary are perfectly spaced. This follows from the fact that the higher voltages will jump from the rotary to the stationary electrodes as they approach each other while the lower ones will have to wait until the gap electrodes reach their nearest common position.

A familiar phenomenon in connection with high speed non-synchronous rotaries is the fact that when they are allowed to

IF YOU ARE A
Government Licensed
Amateur Radio Operator

you should take pride in the fact. The great increase in the number of government licenses held means better radio in the future.

Show that you stand for
BETTER RADIO

by wearing one of the emblems illustrated below.



The emblem is exactly like above cut. It is constructed of 14-Karat gold plate with a blue enameled edge, producing a beautiful effect. A truly artistic button that you will be proud to wear.

Prices (Postpaid)

Emblem coat button	\$1.00
14-karat gold filled ring, 20 year guarantee	3.75
14-karat solid gold ring	9.50

Special prices to radio clubs when ordered in quantities.

Milton Specialty Co.

Two Offices:

Box 34, Columbus Ohio
 Box 11, Philadelphia, Pa.

SAVE YOUR AUDION BULBS WITH THE C-Z FILAMENT PROTECTOR

Greatest Invention since the vacuum tube

Nine-tenths of the vacuum tubes used today are burned out before their life is spent and most times when they are new—by accident. With the C-Z filament protector in the circuit YOU CANNOT BURN OUT AN AUDION NO MATTER WHAT YOU DO.



Blue prints and instructions with each instrument permit even the beginner to connect the instrument in circuit in one or two minutes. These instruments are for panel mounting. They can be mounted inside your ordinary control panel without changing the wiring. Each instrument is calibrated before leaving the factory. C-Z Filament protector as described with signal light, \$5.00. Add postage for one pound.

Crescent City Radio Company

Dept. O, P. O. Box 1104, New Orleans, La.

Read the Classified Advertisements on Pages 500-502. You'll find many good things there.

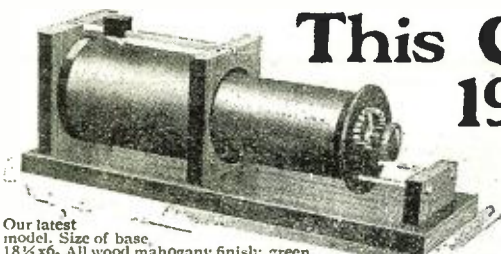

This Coupler at 1916 Price \$7.95

Our latest model. Size of base 18 1/2 x 6. All wood mahogany finish; green silk-cotton windings. Bakelite secondary head; 3,500 meters. Shipping weight, 14 pounds. Catalog number 6A9362—Price..... **\$7.95**

NOTICE!

Complete stock of Radio Apparatus now carried at our Philadelphia store. Order from nearest point.

Laboratory ground switch unit; 100 amp., 600 volts. Don't spoil the efficiency of your set by using a ground switch that leaks. This switch mounted on 35,000-volt insulators. Each unit on iron base with mounting screws, jaws and blades drilled for padlock. Shipping weight, 7 1/2 pounds. Catalog number 6A9207—Price..... **\$6.25**



Sears, Roebuck and Co. - Chicago - Philadelphia

run down and come to a stop and the transmitting key is kept pressed, the signals received at the receiving station invariably get louder as the rotary slows down, and in many cases the sending condenser is ruptured at very low speeds. The fact that the signals always get louder as the rotary slows down is a conclusive argument in favor of low notes. The reason the condenser "shoots", is that in some cases at low speeds the voltage across the condenser may rise to twice the value of the rated transformer secondary voltage, and the condenser as a rule is not built to stand it.

Considering all factors, it appears then that except in the special case where it is possible to have the same amount of energy in each wave train at high frequencies, a low transmitting note is preferable, both because it is more pleasing to the ear, and will cover greater distances for the same power than the high note. This being granted, the question arises as to the best methods for obtaining a smooth, clear, low note.

From the standard 60-cycle alternating current, smooth notes of two frequencies, 120 and 240 cycles can be obtained. In Fig. 7, if sparking occurs at points A, the note will be 120 cycle, while if sparks jump at points B, the result will be 240 wave trains per second. These are the only two frequencies at which smooth notes can be obtained from a 60-cycle current. In order to get these, either a rotary gap run by a synchronous motor or a quenched or stationary gap set to break down at the proper voltage must be used. The synchronous rotary is better, and an ordinary induction motor runs near enough to synchronism to work very well. In the case of the 240-cycle note, the rotary disc must have twice as many studs as for 120 cycles, and some experimenting will have to be done in adjusting the disc to get the smooth 240-cycle note. It can be accomplished, however, with a little patience. If the note is rough the first time, shift the position of the disc with relation to the motor shaft, by turning the disc on the shaft slightly and try again. If it is still rougher this time, shift it the other way and continue shifting until a good note is obtained.

Mention has been made of the special case in which the amplitudes of all the wave trains are made the same at the higher frequencies. This is the case of the ship transmitter, where a 500-cycle generator is used and a spark note of 1,000 cycles per second is transmitted. Under these conditions, as has been explained above, the received signal may be louder on account of the preference of the ear for sounds of about this frequency. However, even in this case there is sometimes very little choice, and long distance work has been done with low musical notes that is yet to be equalled by the 500-cycle ones. A typical example of this is the old WST station who was heard all over the Atlantic and over half the Pacific and who had a note so low that a fast man could come near counting the cycles in it. Another is KHK in the Hawaiian Islands, whose low, musical 200-cycle note sent out press on 600 meters that could be copied on galena in San Francisco, a distance of over 2,000 miles. KPH, the old San Francisco 600-meter Marconi station made what the Marconi Company claims to be the world's record when he worked a boat 5,200 miles away on 600 meters. KPH had about a 240-cycle musical note, while the boat, the Floridian, had a 500-cycle one. KPH also at this time used to clear regularly on 600 meters with boats 3,500 miles out at sea. When war was declared, the navy took over the station and put in a higher power 500-cycle quenched set, and the range was reduced to less than 2,000 miles, despite the fact that higher hot-wire ammeter readings were obtained with the new set. This re-



Learn Telegraphy

(Wireless or Morse)

The **EASIEST, QUICKEST, CHEAPEST WAY**

AT HOME

In Half the Usual Time

WITH THE OMNIGRAPH

"Just Listen—The Omnigraph will do the teaching"

The Omnigraph is an *Automatic Transmitter* that teaches you both the Wireless and Morse Codes, at home, without any expense except the cost of the machine itself. Merely connect to battery and your Buzzer, or Buzzer and Head Phones, or to your Sounder and the Omnigraph will send unlimited messages by the hour, at any speed you desire.

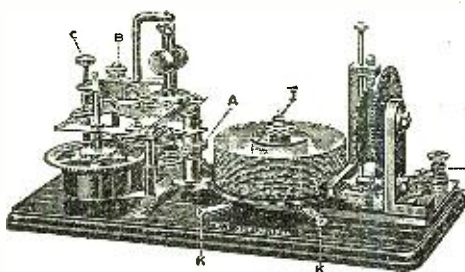

USED BY THE U. S. GOVERNMENT

The Omnigraph is used by the Government in testing all applicants applying for a Radio License. It is also used extensively by the large Universities, Colleges and Telegraph Schools throughout the Country for teaching Wireless and Morse. Hundreds of the Army's skilled operators who served during the war learned with the Omnigraph.

Let The OMNIGRAPH Teach You Wireless

For a few dollars you can have a complete outfit that will make you an experienced operator in the shortest possible time. No hard, laborious work—just learn by listening. The Omnigraph is adjustable so you can start receiving messages slowly, gradually increasing the speed as you become proficient.

You'll be surprised how quickly you will attain speed. Even if you are already an operator the Omnigraph will help you. It will make you more proficient, more accurate and more confident. Thousands of Omnigraphs are in use today and thousands of operators owe their success to them.

Write for Free Catalog

Send for a catalog today, showing the 3 different models, \$14 to \$30. Every Omnigraph is sold with the absolute guarantee that you must be satisfied or your money back for the asking. Mail the coupon today—the catalog will come to you by return mail.

The Omnigraph Mfg. Co.
26 F. Cortlandt St., New York City

The Omnigraph Mfg. Co.
26 F Cortlandt St.,
New York City

Gentlemen:—

As per your ad in RADIO NEWS please mail me your free catalog of Omnigraphs.

Name

Address

City..... State.....

Condenser No. 3 B. D.

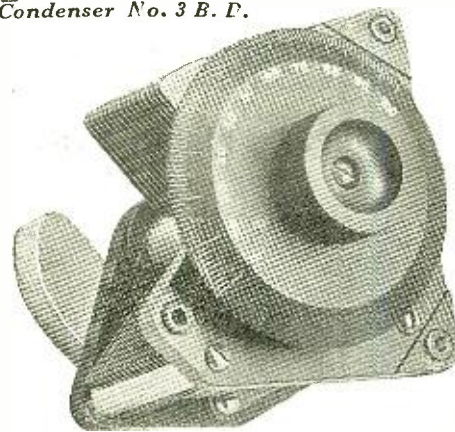

CHELSEA

Variable Condensers

(Die-Cast Type)

- No. 1.—.0011 m. f. mounted\$5.00
- No. 2.—.0006 m. f. mounted\$4.50
- No. 3. B. D.—.0011 m. f. unmounted....\$4.75
- No. 4. B. D.—.0006 m. f. unmounted....\$4.25
- Bakelite Dials only75

Top, bottom and knob are genuine bakelite, shaft of steel running in bronze bearings, adjustable tension on movable plates, large bakelite dial reading in hundredths, high capacity, amply separated and accurately spaced plates.

Unmounted types will fit any panel and are equipped with counterweight. Purchase from your dealer; if he does not carry it, send to us.

Bulletin upon request.

CHELSEA RADIO COMPANY
17 FIFTH STREET, CHELSEA, MASS.
Manufacturers of Radio Apparatus and Moulders of Bakelite

BALDWIN PHONES Special Reduction

The U. S. Navy, the British, French and several other European Governments, in addition to most professional operators, have adopted BALDWIN PHONES as their standard of electromagnetic receiver excellence.

The reason for this preference is apparent. Exceptional sensitiveness combined with ruggedness gives BALDWIN PHONES their popularity. The diaphragm is made of the finest quality selected mica with the force concentrated at the exact center as in high grade phonograph reproducers.

The small armature is pivoted and designed to act as a fulcrum when connected to the diaphragm by a small link. There is no tension or springing of metal as in ordinary receivers. Four-pole pieces of a single solenoid act upon both sides of a highly balanced armature.

Signals that cannot be heard with the best types of ordinary receivers become easily readable with the BALDWIN PHONES.

Improved Type "E" \$19.00
Regular Price 20.00
Original Type "C" 15.50
Regular Price 16.50

These BALDWIN MICA DIAPHRAM AMPLIFYING TELEPHONES, which are shipped direct to us from John Firth & Co., Inc., are absolutely guaranteed to prove fully satisfactory.

The Kehler Radio Laboratories
901 West First St., Dept. R, Abilene, Kansas

ABOUT OUR NEW CATALOG

Our new big catalog No. 102, is now in the hands of the printers and we expect to have them ready for distribution about January 15.

This catalog will contain about 50 pages and will list a complete array of the latest high grade Radio equipment, new apparatus of our own manufacture, parts, etc., as well as other useful and valuable information.

The cost involved in getting out this catalog, restricts its distribution to only those interested and therefore we ask you to send 10 cents for your copy.

However, we do not wish to convey the impression that we want you to "Buy" this catalog. Each catalog mailed will contain a rebate slip, good for 10 cents on your first purchase of \$1.00 or over.

This edition is limited and we advise you to act promptly if you want a copy.



**Penn Radio
Apparatus Co.**
Dept. 102, Reading, Pa.

Canadian Amateurs

**BUY your Radio Apparatus
in CANADA**

and save \$ \$ \$ \$ \$ \$

Murdocks No. 55 Phones
2000 Ohm \$6.00
3000 Ohm 7.25
Rheostats panel mounting 1.35
Series Parallel Switches. .75
Contact Points, per doz. .30

**Radisco Agents
Tresco Condensers**

*Our new Catalogue is ready,
send 5c to cover postage.*

THE VIMY SUPPLY CO.
567 College Street
TORONTO, ONT.

duction in range was greater than could be attributed to Navy "efficiency" or navy radio control, and seems due in part at least to the change in spark note.

On the other hand some wonderful work has been done by JOC on 600 meters. He has about a 600-cycle note and is frequently heard on this side of the ocean with single vacuum tube receivers. VLC, Chatham Islands, near New Zealand, is another 600-meter station with a 500-cycle note that holds a remarkable record, having at least once been copied in San Francisco, over a distance of 6,420 miles, with a single vacuum tube receiver.

So, in conclusion, take your choice between the high and low notes on 600 meters, but unless you have a 500-cycle generator, stay with the low musical ones on 200 and watch the distance records grow.

The Electro-Dynamic Receiver

(Continued from page 487)

nals come in so loud that it can be used as a calling system and a continuous watch with head receiver made unnecessary. A special telemegafone is made for radio use (see Fig. 3).

Static-signal ratio is not increased but slightly decreased when using amplifier and telemegafone. With this apparatus, wireless time signals may be made audible for blocks.

"Bad" Radio Business

(Continued from page 453)

on the manufactured products, but it will eventually tend toward the establishing of a sound base upon which the future construction will develop in a natural way. Natural, as distinct from the way in which all business progressed during the war.

Before you harken to the siren call of the calamity artist, take a look around and see just how the howl about bum business fits into the amateur radio field. Check up the stations owned by yourself and your friends and compare them with what they were a year ago. The result will be that you will probably be convinced that the bum business talk is mostly bunk, as applied to our pet hobby.

And in passing, it may not be amiss to remark that the checking up of the expenditures made for a hobby indicate to a marked degree the general condition of those interested in it. You will find that prices are on the downward incline and that a more stable condition is undoubtedly coming, but the sales do not seem to have materially decreased in spite of the fact that a number of fellows are holding off a little in order to take advantage of further reductions. Radio does not seem to be suffering very greatly and the future seems to be a great deal brighter for it than it does for a number of other lines. We are undoubtedly beginning a prosperous year.

Ideas—Eighth Spasm

(Continued from page 447)

ductance will have a lower resistance thus reducing the resistance of the entire circuit. We have eliminated the resistance always present at the ground connection. Furthermore, we have a perfect dielectric between our plates, a very appreciable gain. All things considered, the lower height is more than offset.

The low resistance permits more current to flow in the circuit, giving a greater transmission range and better reception.

(Continued on page 499)

PACIFIC AMATEURS

**We carry largest Radio Stock
in Northwest**

*Quick Deliveries—Less freight
charges*

AudioTrons \$5.00	Amrad Gaps 1/2 KW. 24.50
Electron Relays 6.00	Keys 3.00 and 4.00
V.T. Amplifiers 7.00	Aerial Switches 4.50
Repaired V.T.'s 5.00	K. & C. Aerial
Bases 1.00	Switches 9.50
Paragon Rheostats 1.75	45 volt B Bats 5.00
Perfection Rheostats 1.50	22 1/2 volt B Bats
Remler Rheostats 1.75	\$1.50, \$2.00, 3.00
Remler Junior 1.00	Radisco coils list
Porcelain 1.25	Corwin dials75c, 1.00
Federal Transformers 7.50	Murdoch loose coup-
Arco Transformers 5.00	lers 9.00
Aeme Modulation	Clamp-Eastham 14.00
Transformer 7.50	Murdoch Phones
Thordarson 1/4 KW. 17.00	2000 ohm 4.50
Thordarson 1/2 KW. 27.00	5000 ohm 5.5
Thordarson 1 KW. 45.00	Baldwin Phones 16.50
Tresco Tuners 15.00	Brandes Navy Phone 14.00
Tresco Trans. Cond. 2.00	Brandes T-A Phones 12.00
Transmitting tubes. 7.50	Brandes Superior
	Phones 8.00

**Distributors for De Forest—Amrad
—Radisco—Audiotron—A.-P.—
etc. Commercial Sets**

Northwest Radio Service Co.
609 Fourth Ave. Seattle, Wash.



Learners "HYTONE" KEY AND BUZZER SETS

With Code and Instructions.
Easily tuned buzzer (2 adjusting screws),
silver contacts.

Price \$1.75
WITH FLAT SPRING KEY \$1.25

Buzzers, unmounted \$0.50
Lever keys unmounted 1.00
High grade lever type sending key,
Bakelite base and knob 1.50
20 amp. Batt. switches, machine
made. Bakelite base and knob.
Single Throw40
Double Throw50

(All postpaid)

AJAX ELECTRIC CO.
Palmer St. Cambridge. 38, Mass.

"A Thousand and One Formulas." A
Laboratory Hand Book for the Experi-
menter and for everybody who wants
to "do things." By S. Gernsback.
Send \$1.75. Experimenter Publishing
Co., 236a Fulton Street, New York City.

ROLLER-SMITH COMPANY

Manufacturers of

**Electrical Measuring Instruments
Meters and Circuit Breakers**

15 Barclay Street New York, N. Y.

VACUUM-TUBES REPAIRED
Marconi—Moorhead—Audiotrons
Four Dollars Each, Postage Paid
Standard Grid Leaks, \$1.25; Bases, 60c;
and Sockets, \$1.00.
THE DALTON LABORATORY
Dalton and Belvidere Sts., Boston, 17, Mass.

A Phony Phone

(Continued from page 458)

sudden I hears a feminine squeal breakin' up the lovin' atmosphere like somebody throwin' a big rock into a smooth, calm lake.

"Say there, you spindly, sap-headed, pernicious, depraved telephone-lizard!" a man's voice comes howlin', like a mad bolshevik sharpenin' a butcher-knife on a grindstone. 'I'll hunt you out an' break every bone in your miserable, worthless body if you don't leave that wife of mine alone.'

"I was so darned flabber-gasted when I hears that, I loses my grip on the tuner bindin'-posts, an' it takes me about a quarter of an hour to get the pressure adjustment back again. When I does, I hears a lot of queer-soundin' whistles an' then another girl, talkin' like a regular fone central.

"Operatuh!" she says, sharp an' business-like. 'Please hurry that number, this party's so drunk he's causin' an awful disturbance here.'

"Then there was some more whistles an' along comes a voice that sounds like it belongs to a walkin' moonshine-distillery.

"Lo, Maggie, dear," he says, an' his voice swings in an' out, like he was staggerin' all around the fone. 'How'r you?'

"Why didn't you come home last night, you vile wretch?" squeals a woman, in a tone that suggests a basket of rollin' pins an' a couple of crates of flat-irons. 'You're drunk again!'

"No Maggie, I ain't drunk," he says, hiccoughin' like a motor with a dirty spark-plug. 'I couldn't come home 'cause I lost my hat.'

"Never mind your hat, you sinkin' beast," answers Maggie, in a tone like a warrior preparin' for battle. 'Come home this instant!'

"But I ain't got no shoes," was the next I hears.

"Where are they?" she asks.

"I dunno," he answers, in a sorrowful sort of a way. 'An' I lost me coat, too.'

"You come home this instant, you drunken sot!" snaps Maggie, talkin' like a Irish teamster rubbin' a couple of brickbats together.

"But, Maggie, dunno where me pants is, neither!" says her intoxicated half, kind of leadin'-like.

"For heaven's sake, where are you?" yells Maggie, in a voice that nearly bends my fone-diaphragms out of shape.

"I dunno, Maggie," he answers, an' then I hears a racket like he'd laid on the fone an' broke it off'n the wall.

"Well, right then I decides I heard enough. I lets go of the tuner an' grabs the handle of my startin' box. I shifts the aerial clips from 'Q' to 'J' an' strikes my arc. Then I starts the chopper an' sends out a CQ for all I'm worth.

"After a few seconds, I slams down my aerial switch an' puts out the arc. Right away, I hears a fellow I know at NPK givin' me a call, an' I starts up again.

"Say, OM," I says to him. 'For the last two days I been hearin' conversations of bootleggers an' affinities an' pantless men, all comin' in on about four hundred meters. Is all that stuff really in there, or am I just losin' my reason?'

Samuel Jones suddenly thot of something and stopt his narrative.

"Say, how about the bet?" he demanded of Cunningham. "Do I win?"

"Sure, you win; what did the navy 'op' say?" laughed the audiotron manufacturer.

"Well, when I puts out my arc I hears him givin' me the big hee-haw.

"No, Samuel, you're no more crazy than usual," he says, sendin' like a man snickerin'

Do you know what a "dud" is?

IF is dough-boy slang for a high explosive shell which amid great fume and fuss has been shot forth to the enemy side and having once reached there falls to the ground and fails to explode. In other words, it is not what it is "cracked up to be" and has failed utterly in its mission.

Research work and much experimenting resulting from the skill and resources of the General Electric Company Research Laboratory prevent "duds" from finding their way into our products.

Radiotrons incorporate the knowledge resulting from the expenditures of vast sums in electrical research, yet they come to the experimenter at a price well within his purchasing ability. Secure one of these—it will prove a revelation in receiving qualities.



RADIOTRON U.V. 200

is the best detector and tone frequency amplifier brought out to date. It operates on a single standard plate battery and has proved excellent for amateur regenerative circuits.

List Price \$5.00

A complete line of vacuum tube ACCESSORIES are now in manufacture and will shortly be available.

Dealers and Jobbers: We have an especially attractive proposition for you. Write us at once.

The Radio Corporation's tubes are covered by patents dated November 7th, 1905, January 15th, 1907, and February 18th, 1908, as well as by other patents issued and pending. Tubes licensed for amateur and experimental use only. Any other use will constitute an infringement.

Address all orders and inquiries to:

SALES DIVISION, COMMERCIAL DEPARTMENT

RADIO CORPORATION OF AMERICA

233 Broadway, New York City



RADIOTRON U.V. 201

has been judged an exceptional amplifier of the Pilotron type and proves advantageous for detection and for radio as well as tone frequency amplification. The filaments operate from a 6-volt storage battery.

List Price \$6.50

Ready for instant mailing: two valuable bulletins containing explicit and detailed data as well as many practical circuit diagrams employing these two Radiotrons.

"A Thousand and One Formulas," A Laboratory Hand Book for the Experimenter and for everybody who wants to "do things." By S. Gernsback. Send \$1.75. Experimenter Publishing Co., 236a Fulton Street, New York City.

New 1920 RED HEAD PHONES

\$12.50

We announce the new model of the famous Red Head Radio Receivers greatly improved, 3200 ohms, \$12.50 the pair. Distributors for DeForest, Murdock, Signal, Suncell and other famous lines.

The Newman-Stern Co., Dept. Q.S.T., Cleveland, O.

ARLINGTON TESTED CRYSTALS

For over five years the accepted standard for crystal detectors, Galena or Silicon, individually tested and packed in tin containers, postpaid, 35c crystal.

We are distributors for Murdock, DeForest, Signal and all standard lines.

35c

THE NEWMAN-STERN CO., Dept. R.N., Cleveland, O.

What a Dime Will bring You From the Nation's Capital

The little matter of 10 cts. will bring you the Pathfinder eight weeks on trial. The Pathfinder is an illustrated weekly, published at the Nation's center, for all the Nation; an independent home paper that prints all the news of the world and tells the truth; now in its 28th year. This paper fills the bill without emptying the purse; it costs but \$1 a year. If you want to keep posted on what is going on in the world, at the least expense of time or money, this is your means. If you want a paper in your home which is sincere, reliable, entertaining, wholesome, the Pathfinder is yours. If you would appreciate a paper which puts everything clearly, strongly, briefly—here it is. Send 10c to show that you might like such a paper, and we will send the Pathfinder on probation eight weeks. The 10c does not repay us, but we are glad to invest in new friends. Address: THE PATHFINDER, 436 Lanndon Sta., Washington, D. C.

Washington has become the World's Capital and reading the Pathfinder is like sitting in the inner council with those who mold the world's destiny.

UTTMARK'S NAUTICAL ACADEMY RADIO SCHOOL

NEW YORK BOSTON

Offers a thorough course in all branches of wireless telegraphy. Radio Operators earn at the start \$125.00 per month, and first class board, etc., free.

Our school prepares you for your license in three to four months. Positions guaranteed to first grade licensed operators.

Day and evening classes.

Nautical Academy established 1804

CAPTAIN F. E. UTTMARK, Principal

Write, call or phone for illustrated booklet.

8 STATE ST., NEW YORK, N. Y.

Facing Battery Park, N. Y.
Telephone, Bowling Green 8079

UTTMARK'S for Nautical Education

DON'T READ THIS

if you are indifferent to accurate work.

By turning a disc you can find CUBE ROOTS, square roots, cubes and squares, to four decimal places. CHARLIE also has a protractor, a centimeter and millimeter rule, and an inch rule. He is of unlimited value in Arithmetic, Algebra, Geometry, Trigonometry, etc. Charlie works faster and easier than any slide rule. He surprises every one. Charlie is pocket size.

Orders for more than one Charlie cannot be accepted. We are rushed with hundreds of orders a day, so

MAIL THIS COUPON NOW TO

Charlie Box 548 Yale Station
New Haven Yale University Connecticut

Kindly send me one Charlie for which I enclose fifty cents.

Name

Address

Immediate delivery guaranteed.

1/4 H. P., 110 volts, A. C., 60 cycle, single phase, 1750 R. P. M.

MOTORS

LARGE QUANTITIES NEW WASHING MACHINE MOTORS

These are of standard manufacture and carry the full factory guarantee. Shipped in original boxes. Complete as cut. Suitable for operating Coffee Grinders, Cream Separators, Bottle Washers, Air Compressors, Sewing Machines, Etc.

Mail \$5.00 cash or money order. We will send C. O. D. subject to full examination. MONEY BACK GUARANTEE.

Write for CATALOGUE Special Quantity Prices-Value \$25.50

\$22.75 Each

MANUFACTURER'S DISTRIBUTOR

CHAS. H. JOHNSTON - Box 16 W. E., Pittsburgh, Pa.

RADIO CLUB PINS

Special folder of designs and prices in addition to regular school pin and ring catalog free on request. Be sure to see these new numbers which will put new life in your club

Metal Arts Co., Dept. 11, Rochester, N. Y.



You can be quickly cured, if you STAMMER

Send 10 cents for 288-page book on Stammering and Stuttering. "Its Cause and Cure." It tells how I cured myself after stammering 20 yrs. E. N. Bogue, 856 Bogue Bldg., 1147 N. Ill. St., Indianapolis.

up his sleeve. 'You've been listenin' to the Bell Telephone Company's wireless fone between Los Angeles an' Catalina Island. It's hooked right onto the Bell System an' works the same as a common, ordinary wire.'

"Thanks, OM," I answers, quite briefly. 'An' I goes out to get some fresh air.'

The Mystery of the Damp-Undamp Messages

(Continued from page 459)

For three minutes the machine that Edison had designed for office purposes, recorded several thousand dots and dashes. Then they ceased—the machine recording only static.

Hendon released the little lever that stopt the machine, took the cylinder off, and placed it upon the transcriber. He then inserted the two tubes of the transcriber in his ears and started the cylinder revolving. This second machine was set just four times slower than the first—consequently the signals that buzzed in Hendon's ears were spelling out on an average of twenty words a minute.

Nothing broke the silence but the ticking of a watch and the sound a pencil makes when it is furiously scribbling off a series of words; nothing, perhaps, save a quiet "cuss-word" or two emanating from the holder of that pencil. The owner of the pencil had just cause to indulge in quiet cussing . . . the message in its entirety was transmitted in what was unintelligible to Hendon—*Spanish!!!*

"Come on, Vin!" Hendon shouted, when he had completed the message, as he started for his hat, "there's only one man in this burg that knows Spanish, and that's Shaw—the Deputy Sheriff!"

"Hm," the bronze-faced man beside the stove mused, as he read the scrawled message Hendon had just given him, "an' when did you say you got this?"

"Just now, sir, but it's only one of several, because I've been trying to dope them out for five days now."

"Well, it makes darn interestin' readin', anyway. I'll tell you boys all about it in a day or so; wouldn't want to let it out now." And with this Shaw rustled his lanky frame out of the chair and prepared to depart. A minute later Hendon and his chum saw the red tail lamp of the Sheriff's car as it sped down the Santa Rita trail. . .

It was two days later, after Shaw had returned from his mysterious visit to the South, that Hendon and Lopez were again in the former's radio room. The strange message had been of Mexican origin, according to the Sheriff, but its exact source had not yet been determined.

"Say, Vin, I wonder why those greasers used that fake call. TVA, you know, has not been assigned yet. And how in the deuce did they ever get hold of an undamp transmitter?"

"You can search me," Lopez replied, "unless it was that new station over in Mexipoli that opened up last month."

"By golly, I forgot all about that one. It's only a little over a hundred miles from here, too!"

"That's true, Bill, but the Federal Government owns and operates that station, you know," Lopez argued.

"You mean that it used to be run by the Federal Government, Vin, but two weeks ago the Tazzapists captured the whole town!"

Hendon was temporarily correct in his statement that the Mexipoli radio station was in the hands of the revolutionists, but a week later the news came that the town was again in the hands of the Federal troops. The night following this announcement found Hendon at his radio instruments, as was his wont every night. He

Canadian Experimenter's Supply House

We carry a complete line of Radio Apparatus. Special parts made to specification. Government Telegraph Keys, 70c to clear.

Write for our new catalogue.

J. M. PAQUIN
The Electrical Shop
787 Queen St., West
Toronto, Ont.

TUSKA C. W. INDUCTANCE

Type 181 Unmounted

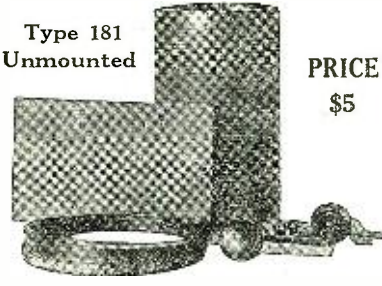

PRICE \$5

Use a Tuska C. W. Inductance in your new tube set. Our illustrated Booklet 5 cents.

THE C. D. TUSKA COMPANY
HARTFORD, 3 - CONN.

PLATE BATTERIES CUSTOM-MADE!

Made for Heavy Duty and Made to Last! Batteries that Win Golden Praise from Every User!

A new 22 1/2 volt unit made up of large size powerful flashlight batteries, soldered together with 1/4 inch brass strip, the positive and negative terminals being of the same and drilled for bolt and nut connections.

The VOLTAGE IS VARIABLE by means of clipping on to the brass strip connectors. NO WIRES TO BREAK OR CORRODE. SPECIALLY MADE FOR LONG LIFE AND HEAVY DUTY.

Price f. o. b. anywhere in the U. S. \$2
Black fiber panel 7 x 20 x 1/4 inches suitable for a Paragon set. \$3.

ECONOMY RADIO SUPPLIES CO.
232 Sanford Street East Orange, N. J.

Experimental Electricity Course in 20 Lessons

By S. Gernsback and H. W. Secor, E. E.

Every phase of experimental electricity is treated comprehensively in plain English. New experiments are described and explained and nearly every application of Electricity in modern life is given in simple language.

128 pages and more than 400 illustrations.

Flexible cloth cover, per copy 75c
Stiff cloth cover, per copy \$1.25

Postpaid

Experimenter Pub. Co. 236a Fulton St. N.Y.C.

CANADIAN AMATEURS ATTENTION!

Send 5c in stamps for our new price lists. Contains useful information for amateurs such as International Abbreviations, Press schedules of spark stations, undamped wave stations, wireless code, history of wireless telegraphy, etc.

SMITH BROTHERS
302 S. Christina St., SARNIA, ONT.

had just completed his usual evening's conversation with Lopez, and was adjusting his apparatus for NAA's time signals, when he caught the unmistakable squeak of the supposed TVA. They were not sending, as before, on 16,000 meters, but on the more frequently used 2,500.

"6XCV 6XCV 6XCV de XOL." They were calling him!

XOL was the new undamp't station at Mexipoli! TVA and XOL were the same!

To the tune of his high-speed rotary, the acknowledgment flew back to the Mexican station. Then came the message:

"Radio Mexipoli, 1 kl twenty-second, 9:55 P. M.—To U. S. Deputy Sheriff G. H. Shaw Juanista Arizona, stop eighteen suspects captured in raid on your advice stop in custody here connection attempt to smuggle ammunition over Border to Revolutionary troops, stop leader yet at large, but information our possession doubtless be means of apprehending him, stop wireless telegraph apparatus confiscated in raid used to communicate with this station last week while in hands of Tazcapists.

"MONTE VALNES, Commandant."

Twenty minutes later Hendon handed the radiogram to Shaw, who was just preparing to retire. After reading the message over twice, he tugged at the uneven ends of his moustache and drawled: "Well, Bill, I reckon you'll have a free trip over the line at the Government's expense, as a witness. While you didn't actually witness anything, yet you sorta started things hummin when you and Vincent busted in on me that night."

"I'll give it up, darn it!" exploded the elder brother of the Lopez household, as he tried to receive a message by radio from his friend Hendon.

"Wassa matter?" his younger brother inquired, with childlike simplicity.

"Aw, ever since Bill made that darn automatic tape transmitter like he saw down at the greasers' station, he speeds up to forty words a minute. How the deuce does he expect me to 'get' him?"

The "kid" brother remained as if in deep thot for a moment and then burst out, "Well, Vin," running for the open door, "maybe you could get Bob Harris down at the First National to let you use their old dictating machine!"

Ideas — Eighth Spasm

(Continued from page 496)

The decrement is lowered also enabling us to emit a pure, sharp wave with greater carrying power. Why that little ol' ammeter will be bumping against the nail at every blast of the gap. And its amperes in the aerial circuit that means long distance work, be it sending or receiving. Consider the sharp tuning possible with an aerial circuit practically free of damping.

With the plates square it is reasonable to suppose that radiation and reception would be the same in all directions. If a long narrow "Plate" aerial is used then directional effects would no doubt be noticed. Two parallel wires, one above the other, would answer the purpose and undoubtedly would be superior to a single wire aerial. Why not run another wire below your present single wire aerial and give the idea a hitch?

I wonder, and not without reason, if the "Plate" aerial will not kill for all time the static that sends sane, peaceful men reeling from the set uttering blasphemies on all that is good and great. And will it reduce induction to zero, minus?

Don't you think it's worth trying? It may mark a slight advance in the game but one worth while if we can do away with the bulky aeralns now in use. A coil aeraln won't do and this is another alternative that may solve the problem.

Build your own apparatus Use Wilcox Parts



All prices post paid.
Catalog sent for 5c.

Reliable dealers
wanted.

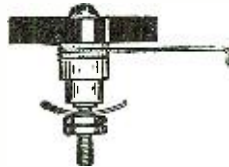

Type 101 Panel Switch

A beautiful and efficient rotary switch for general use. Furnished in two sizes. 1" radius brass finish 40c. Nickel finish 50c. 1 1/2" radius brass finish 50c. Nickel finish 60c.

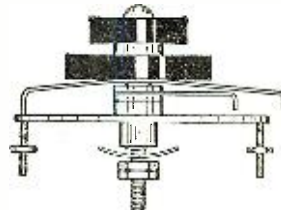

Type 102 Panel Switch

A compound switch consisting of two electrically independent switches mounted with concentric knobs. 1 1/2" radius brass finish \$1.10. Nickel finish \$1.25.

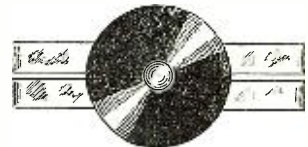

Type 103 Panel Switch

A rotary panel switch which is double pole and double throw. Will change variable condenser from series to parallel, etc. 1 1/2" radius brass finish 75c. Nickel finish 85c.



Type 104 Panel Switch

A complete unit for back of panel mounting. The latest and best in rotary panel switches. Better looking, more efficient and easier to mount. Complete with Type 116 Dial and 6 contacts \$2.25. Complete with Type 116 Dial and 11 contacts, \$2.50.

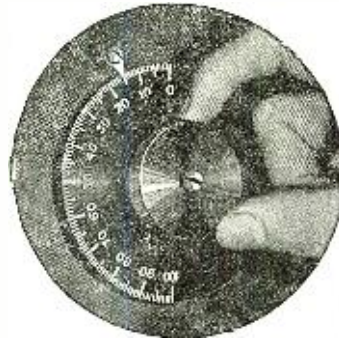

Type 116 Indicating Dials

Of polished hard rubber accurately engraved, filled with brilliant white, furnished complete with knob and bushing to fit 3/16" shaft. 90° scale 0-50 or 180° scale 0-100. 2" diameter \$1.25. 3" diameter \$1.50.



Type 121 Rheostat

Suitable for table or back of panel mounting. Has turned aluminum case, convenient binding posts and 6 ohm resistance unit with all off and all on positions. Long bearing and special designed blade insure smooth running and positive contact. Only occupies space 2" in diam. on your panel. No. 121A with Type 116 Dial \$2.50. No. 121B with Knob and Pointer \$1.75.



Type 14B Rotary Disk

The same style rotor as used on our famous belt driven gap, only with bakelite center and brass bushing to fit your motor shaft. Size is 4 1/2" diam. and 9/16" thick. This rotor being light and perfectly balanced will give excellent results on any small high speed motor. State size of shaft when ordering. No. 14B Rotary Disk \$6.00.



Variocoupler Rotor

A carefully turned hardwood form for the secondary coils of variocouplers, etc. Size is 3 1/2" in diameter and 2" wide. No. 101 Rotor \$1.00.



Type 5A Variometer

Made from Wilcox Variometer parts, completely assembled as illustrated, may easily be mounted on panel if you wish. Wave length range in average circuit with coils in series about 175-450 meters. No. 5A Variometer \$8.

THE WILCOX LABORATORIES, INC.
LANSING "Manufacturers" MICHIGAN

Canadian Amateurs

Write to our nearest branch for
Price List "B" of Radio Apparatus,
Supplies and Publications.

Scientific Experimenter Limited

Dominion Bldg.,
Vancouver, B. C.

Arcade Bldg.,
Halifax, N. S.

Head Office,
11 St. Sacramento St.

Confederation Life Bldg.,
Winnipeg, Man.

Vaughan Electric Co.,
94 Germain Street
St. John, N. B.

MONTREAL, QUEBEC

93 King St., E.,
Toronto, Ont.

Board of Trade,
St. John's, Nfld

Show Rooms,
33 McGill College Avenue

READ the CLASSIFIED ADVERTISEMENTS on PAGES
500-502. YOU'LL FIND MANY GOOD THINGS THERE.

OPPORTUNITY AD-LETS

Follow these advertisements every month. Reliable advertisers from all over the country offer you their most attractive specials in these columns.

Classified advertising rate six cents a word for each insertion. Ten per cent discount for 6 issues, 20 per cent discount for 12 issues. Name and address must be included at the above rate. Cash should accompany all classified advertisements unless placed by an accredited advertising agency. No advertisement for less than 10 words accepted.

Objectionable or misleading advertisements not accepted. Advertisements for the March issue must reach us not later than February 10.

THE CIRCULATION OF RADIO NEWS IS OVER 40,000

EXPERIMENTER PUBLISHING CO., INC., 233 and 236 Fulton Street, New York, N. Y.

Automobiles.

Six Gold Initials for your auto, 25c coin. Lafave, 134 W. Park St., Watertown, N. Y. ..

Automobile Accessories.

Auto Motors Supplies.—Buick, Michigan, Stoddard-Dayton, E. M. F., Cadillac, Overland, Continental and Buda Motors. All types \$50 each and up. Special High Tension Magnetos 2 and 4 cylinder, \$9.50 each. Electric & Gas Head Lamps, Coils, Carburetors, Air Compressors, Generators, Starters, etc. Write for catalog. Address Motor Sales Dept. 16, West End, Pittsburgh, Penna.

Aeronautics.

Build the Latest Aeroplane Models. Exact duplicates of those in use today. Accurate models that fly are built from Wading River scale drawings. Our new catalog completely illustrating each individual model contains 52 pages of live information and 24 of the latest models, also a full line of supplies for Model Building. Send 10c for your copy. Wading River Mfg. Co., 672 H Broadway, Brooklyn, N. Y.

Boys Make a Model Aeroplane That Will Fly. Easily made at small cost. Write for circular. Aero Shop, 658½ Hurlbut Ave., Detroit, Michigan.

Motor Engines and Dynamos.

Special Garage Motors: New; manufactured by General Electric Co. ¼-Hp., \$22.75; 1-Hp., \$88.50; 2-Hp., \$126.50; 3-Hp., \$146.50; 5-Hp., \$188.50. All sizes both single and Polyphase Motors for immediate delivery. Special charging generators all voltages. Write for catalog. Motor Sales Dept. 16, West End, Pittsburgh, Penna.

Steam Engines, one horsepower, \$18. James Chambliss, Jasper, Ala.

Motorcycles—Bicycles.

Don't Buy a Bicycle Motor Attachment until you get our catalogue and prices. Shaw Mfg. Co., Dept. 1601, Galesburg, Kans.

American Made Toys.

An Opportunity for Home Workers on small scale and manufacturers on large scale to make American Metal Toys. Army, Navy, Machine Guns, Cannons, Warships, Indians, Cowboys, Wild Animals, Whistles, Bird-Whistles, Religious designs and other toys and novelties. Greatest chance for industrious people to have an independent business. Enormous demand for cheap toys offers unlimited field and great future all over United States and foreign countries. Experience, or tools not necessary. Hundreds and more made complete per hour. Casting forms, complete outfit for \$8.00 up. We buy these goods paying fixed prices. Attractive prices offered for painted goods. A strictly business proposition. No one need apply unless he means business. Booklet and information furnished free. We have no sales agents and we warn against worthless and cheap imitations. Toy Soldier Manufacturing Co., 32 Union Square, New York.

Agents Wanted.

Agents—Sell My Sanitary Wash Machine. Postpaid \$2.00. Owen Obetz, Hayesville, Ohio.

Help Wanted.

Stop Daily Grind. Start silversmithing, auto headlights, tableware, etc. Plans free. Clarence Sprinkle, Dept. 48, Marion, Indiana.

Earn \$25 Weekly, spare time, writing for news papers, magazines. Experience unnecessary; details free. Press Syndicate, 5665, St. Louis, Mo.

Be a Mirror Expert. \$3-\$10 a day; spare time home at first; no capital; we train, start you making and silversmithing mirrors, French method. Free prospectus. W. R. Derr, Pres., 579 Decatur St., Brooklyn, N. Y.

Detectives Earn Big Money. Excellent opportunity. Travel. Great demand everywhere. Fascinating work. Experience unnecessary. Particulars free. Write, American Detective System, 1968 Broadway, New York, N. Y.

Books.

The Amateur Electrician. Pocket size, 20c (coin). Joe Tillberg, Proctor, Vermont.

Advertise in 100 Magazines. Words 9c each; three times 18c each. Concordia Magazine, 9A Water, York, Penna.

We Buy and Sell back issues of Radio Amateur News and Electrical Experimenter. Boston Magazine Exchange, 109 Mountfort St., Boston, Mass.

READ THIS TESTIMONIAL LETTER

This is just a sample of what all our advertisers say about Radio News' Opportunity Ad-lets.

350 Sprague St.,
Fall River, Mass.

Dear Sirs:

Please publish the enclosed ad in "Radio News," January issue.

**YOUR MAGAZINE BRINGS
BETTER RESULTS THAN ANY
I KNOW OF.**

Yours truly,
ROLAND PLACE.

Business Opportunities.

Boys! Boys! Send 25c at Once for my unequalled plan of turning your spare time into money. You will be glad you did. Curtis Bourne, Omaha, Nebr., Box, 619.

If You Want to Sell or Exchange your farm, unimproved land, city property or patent, write me. John J. Black, 194th St., Chippewa Falls, Wis.

Special Service Magazine published monthly to help you make money. Plans, schemes and ideas. Stamp brings descriptive circular. J. R. Kerr, P. O. Box 291, Brooklyn, N. Y.

Substantial Manufacturing Corporation wants capable men to establish branch and manage salesmen; \$300 to \$2,000 necessary. Will allow expenses to Baltimore as explained. Address Mr. Clemmer, 603 N. Eutaw St., Baltimore, Md.

25c Coin Brings household necessity and wholesale price. Wonderful seller. Lafave, 134 W. Park St., Watertown, N. Y.

Big Money in Your Spare Time manufacturing letters for signs; no experience—free particulars. H. F. McPherson, 675 Brown Ave., Butler, Pa.

Real Honest to Goodness Start. That's what I've given hundreds of Agents. Small Manufacturers with limited capital, desiring to make their own high-class, big selling specialties in all lines. With my correct formulas they soon realized that manufacturing is where the money is. My valuable literature descriptive coconut creme custard, allmixt cake, vanilla concentrate, chocolate milk beverage (powdered), non-alcoholic flavors, pie fillers, Cero fruit butter, Magic wind-shield cloths, Ovitone doubles egg production. Latest washing tablets, powders and hundred other valuable manufacturing propositions for stamp. Muller, Chemist, Tampa, Florida.

Health.

Pyorrhea (Rigg's disease—bleeding or swollen gums)—hundreds have been helped by "Home-Rem," the successful home pyorrhea treatment. Purifying, healing, preventative. Full month's treatment, consisting of a very beneficial massage paste and an antiseptic tooth-cleansing paste to be used in place of your ordinary dentifrice, together with full directions for treatment. \$1 postpaid. Or write for free booklet "E." Home-Rem Mfg. Co., 439 Seventh St., Brooklyn, N. Y.

Tobacco or Snuff Habit Cured or no pay; \$1 if cured. Remedy sent on trial. Superba Co., SB, Baltimore, Md.

Instruction.

Saxophonists. Wonderful correspondence course ready. Write Virtuoso School, Buffalo, New York.

Miscellaneous.

Let Me Send You a Complete Diagram for burglar alarm system for only 50c. Groomer, 1607 East 8th St., Kansas City, Mo.

Big Mail Free! Just send your name. W. E. Fitzpatrick, Box 722, Chicago, Illinois.

News Correspondents.

Earn \$25 Weekly, spare time, writing for newspapers, magazines. Experience unnecessary; details free. Press Syndicate, 566 St. Louis, Mo.

Office Devices.

We Buy for Cash, Rebuild and Sell for about half new price, multigraphs, addressing machines, duplicators, etc. Don't be misled by firms infringing on our name. We are the original Office Device Company, 154-C West Randolph, Chicago.

Phonographs.

Build Your Own Phonograph. Big saving. Blue prints, parts price list, instructions free. Associated Phonograph Co., Dept. R-N, Cincinnati.

Build Phonographs.—Send two cent stamp for catalogue of reliable motors, tone arms, hardware, cabinets. S. R. Kremer, 118 West Court St., Dayton, Ohio.

Patent Attorneys.

Patent.—Send for free book. Contains valuable information for inventors. Send sketch of your invention for Free Opinion of its patentable nature. Prompt service. (Twenty years' experience). Talbert & Talbert, 4927 Talbert Bldg., Washington, D. C.

Millions Spent Annually for Ideas. Hundreds now wanted. Patent yours and profit. Write today for free books—tell how to protect yourself, how to invent, ideas wanted, how we help you sell, etc. 301 Patent Dept., American Industries, Inc., Washington, D. C.

Patents For Sale.

A Good Investment Patent for Sale. New Triple Cut meat slicer, operated by electric current. P. M. Anderson, 1137 N. Waller Ave., Chicago.

Patent for Sale or royalty; grain-door for box car. Material and time saving. Write John M. Carlson, Sandstone, Minn., Route 1.

Sale.—Patented improved door lock, outright or royalty. Thomas Severance, Ware, Mass.

For Sale.—Patents United States and Canada, a collapsible baby walker, or capital to manufacture. John Webber, 38 Austin St., Rochester, N. Y.

Printing.

3,000 Two Color Labels, \$1.25. Irvin J. Wolf, Station E, Philadelphia.

100 Name Cards, leatherette case, 75c. Agents 50% profit. \$5.00 daily. Information, Wolf, Desk J, Station E, Philadelphia.

Novelties.

Genuine Indian Baskets. Wholesale catalogue. Marion Gilhams, Highland Springs, California.

Stamps and Coins.

California Gold Quarter size and Colombia nickel coin 30c; Italy 10 Centimes and catalog 10c. Homer Shultz, King City, Mo.

500 Different Stamps, \$1.40; 200, 30c.; 100, 13c.; approvals. Michaels, 5600 Prairie, Chicago.

20 Different Denmark, 10c. Approvals—ret. Wm. Browne, 111 Willow, Wollaston, Mass.

Stamps—Norway, Sweden, Denmark—25, 12 cents. Ruprecht, 1231 14th Street, N. W., Canton, Ohio.

Stammering.

St-Stu-t-tering and Stammering cured at home. Instructive booklet free. Walter McDonnell, 121 Potomac Bank Bldg., Washington, D. C.

Song Poems.

If it is Anything in Music, write to Wm. E. Giles Music Studio, Blanchard, Wash.

Song Writer's Manual and Guide sent free. Contains valuable instructions and advice. Submit song-poems for examination. We will furnish music, copyright and facilitate publication or sale. Knickerbocker Studios, 311 Gaiety Bldg., New York.

Scenery for Hire.

Collapsible Scenery for all plays. Amelia Grain, Philadelphia, Pa.

Telegraphy.

Telegraphy (both Morse and Wireless) and Railway Accounting taught quickly. Tremendous demand. Big salaries. Great opportunities. Oldest and largest school; established 46 years. All expenses low—can earn large part. Catalog free. Dodge's Institute, M. St., Valparaiso, Ind.

Wireless.

Genuine Double Filament Audiotrons Free for ten days' trial. Send for one today, as it will be your last chance to get the genuine hand made double filament audiotron detector, oscillator and amplifier vacuum tubes all in one for \$5.50. Postpaid and Insured to arrive in perfect condition to any address, as the manufacturers have discontinued to manufacture same. Test it any way you care to, for sensitiveness. Compare it for ruggedness and try it for distance and long life, as compared with others. Remember it has two filaments, and, when one burns out, you don't have to throw the tube away, but, burn the other filament. In other words two Vacuum Tubes for the price of one. The Filaments are guaranteed for over 2000 hours' operating life, and no special socket is required. Plate voltage under 40 and the filament uses a 6 Volt battery. No more than three to one person. Also a very appropriate gift for Christmas which will be appreciated. If dissatisfied in any way your money back without question. To insure prompt shipment on same day your order is received then send only money orders to "AudioTrons", Box 18, STATION W, Brooklyn, New York.

Attention Radio Phonists.—Money Refunded, if this set does not work. Here is a phone set that costs only Seventeen dollars and forty cents to construct and knocks 'em dead. I'll tell the world it works. It operates on B. Batteries and will transmit 15 miles. I positively guarantee results. This is just what you have been looking for. Enclose one dollar for hook up and directions. H. D. Selvage, 1096 Clinton Ave., Dept. R, Irvington, N. J.

Begin By Thoroughly Learning Code. Students of Dodge Short Cut Method memorize Continental Code in one hour. Thousands have and you can. Information and testimonial giving street address free with no obligation. Method costs 50 cents. Saves 50 dollars' time. No beginner can afford not to investigate. C. K. Dodge R.N., Mamaroneck, N. Y.

All Amateur Apparatus bought or made in accordance with The Radio Buyers' and Builders' Handbook invariably re-sells very profitably. Study my June and July display advertisements in Q. S. T., see why, and get your copy now. R. Clark, Barnes Rd., Newton, Mass.

Radio Operators.—For your benefit we maintain a Special Department, under direction of a Commercial Operator, who understands the needs of the Amateur in giving his station a Commercial atmosphere. We have prepared the following Specials: The "Commercial Set" of neatly printed signs of proper size upon durable cardboard needed in every Amateur or Commercial station, postpaid 20c silver; Radiogram Blanks, generous supply, postpaid 10c silver; Radio Station Data Card (something new) postpaid 10c silver. Above "Commercial Outfit" complete, postpaid, 85c silver. Radio Dept., The Auburn Novelty House, 123 Richard St., Auburn, Rhode Island.

(Wireless—Continued.)

Bargains in Moorhead VT's. Electron Relays, \$5.50; Oscillator-Amplifier, \$6.50; Transmitter tubes, \$7. F. J. Demarest, 811 Walnut St., Williamsport, Pa.

Attention.—Rogers Underground Aerial Experimenters for sale. 300 ft. brand new high tension rubber covered wire, 1/2 inch solid rubber insulation, 10c a foot, cut to any length. Also 30 brand new 6V. 70 Amp. storage batteries of a standard make (can't adv. the name), \$18 a piece. Elmer Horlacher, R.D.S., Dayton, Ohio.

Learn to Telegraph at Home. Send 2-cent stamp for code card and descriptive circular of \$1.25 learners' instrument. C. L. Redding & Co., 202 Main St., Everett, Mass.

Radio Amateurs. Have bought up radio instruments. Send stamp for list limited supply. N. Sameth, 240 Varet St., Brooklyn, N. Y.

6,000 Miles On a Single Bulb. 175 to 20,000 meters. Simple diagram of a complete short and long wave receiver, both arc and spark, with which we read Honolulu 6,000 miles, Germany 4,000 miles, San Diego, Calif., British Stations, and practically all the high powered foreign and domestic stations. Amateur and spark stations together with telephone and music come in good. Diagram and complete instructions mailed for 50c in coin or stamps. Virginia Novelty Co., Martinsburg, W. Va.

Good Radio Receiving Sets, \$8.50 and Up. Panel transmitting sets, \$30.95 and up. Radiophone apparatus, wire supplies of all kinds. Catalog 6R for two-cent stamp. Pocket code card free. Jenkins, 923 Purchase St., New Bedford, Mass.

Radio Paper. Radio telegram blanks for your station—for delivering messages and for station file. This is the last word of efficiency for super-sensitive receiving sets. Blanks well printed on good grade of telegram paper. Hundred sheets per pad. Send your order today for a supply of these forms and install a system that will make operating a pleasure. Enclose M. O. or cash, or send your order and blanks will be shipped collect. Price: One hundred, twenty cents; \$2.00 per thousand. Special prices on quantities. Radio-form Printers, 207 Baker Bldg., Racine, Wisconsin.

Grid Condensers prepaid anywhere, \$.50 each. Ingenious invention makes it possible to hermetically seal very small capacitances in very small compartments. Not exposed to changes of atmosphere. 100% efficiency performance test. Works with any type tube. Crescent City Radio Company, Dept. D., P. O. Box 1104, New Orleans, La.

Something New! A DeLuxe regenerative set; can be used both for receiving and for transmitting CW or radiophone; complete in one unit. Works great. Handsomely made of finest materials. Employs a radically new hookup. Comprises two variometers, anmeter, microphone, two rectifier bulbs, filter, plate-filament transformer, power bulb, switches, dials, etc. Simply connect to 110 AC and talk, or receive. No batteries needed. Have several of these sets. First money-orders take them. Price each, complete, \$60. Double variometer regenerative sets for amateur-commercial reception, \$25. Same for 200-20,000 meters, \$45. Completely mounted and finished. These sets beat anything now on market. P. H. Craig, 3397 Glenmore Ave., Cincinnati, Ohio.

Radio and Audio frequency amplifying transformers, most efficient and yet cheapest priced on the market. Retail for \$5. Our price, \$4.50. Prepaid and insured to destination. Satisfaction guaranteed. Send money orders to I & S Radio Company, 87 South First St., Brooklyn, N. Y.

Radio Phonists Attention: High voltage generators. We supply motor generator units in various capacities especially designed for radio phone work. Low powered rotary converters, dynamometers, fractional H.P. motors, storage batteries. Various types of meters, condensers, navy type 4" nickel finish brass engraved dials, spark gap rotors, synchronous spark gaps. RAY-DI-CO radio phone sets furnished knocked down ready for assembling and your connection. Become acquainted with our service. RAY-DI-CO, 2653A N. Clark St., Chicago, Ill.

Just the Thing for a Sending Set. Used Ford spark coils, only \$1 a piece. Six for \$5. Without vibrator, 75c each. Coils will give an inch spark. Harold Hubinger, Keokuk, Iowa.

Amateurs Attention.—We are now able to furnish the Famous New Three Plug "Fasco Honeycomb Coil Mounting" for cabinets or unit panels. A few good points about these mountings, solid bakelite, solid construction, expert workmanship, fine tuning, and no body induction since we employ our new extension levers. Price each \$7. Satisfaction guaranteed. We ship within 24 hours after receipt of order. No C. O. D. Be a Fasco booster in your town. Fasco Radio Apparatus. Mr. M. Schneider, 112 Weld St., Rochester, New York.

Radio Message Blanks with your call letters printed on each blank. In pads of 100 with call, 45c. Without, 35c. Sample for stamp. Philadelphia Radio Supply, 5714 Hazel Ave., Philadelphia.

(Wireless—Continued.)

Richmond, Va. Announcing my appointment as Delfelco agent for this city. Anything in radio. Tel. Mad. 6689-J. Walter Johnson, 512 Mosby St.

Variocouplers. Bakelite throughout, \$6. Variometers, \$6. All postpaid. Bakelite tubes and panels. Dealers write for special discount on variocouplers. Meade bakelite radio apparatus. 975 Putnam Ave., Brooklyn, N. Y.

Chemicals.

Chemical Supplies. Specialty of dime quantities, state your needs or send for lists. John Sheckels, 1128 Carroll St., Baltimore, Md.

"Practical Laboratories" made for practical experimenters. High-grade, reasonably priced outfits for beginners and advanced students. Interesting literature free. D. Altman Company, 223-225 East 110th Street, New York.

Correspondence Courses.

Dollars Saved. All kinds of used correspondence courses sold. (Courses bought). Lee Mountain, Pisgah, Alabama.

Electrical Supplies and Appliances.

Water Locating by Mansfield's water finder is interesting and profitable. Particulars from Edwin Mansfield & Co., 94 Victoria Road, New Brighton, England.

For Advertisers.

Don't Experiment. White space is too costly. Let Jacobus write your advertising. Letters, \$3.50. Jacobus Advertising Service, 41 Bruen Ave., Irvington, N. J.

Personal.

Astrology.—Stars tell life's story. Send birth-date and dime for trial reading. Eddy, 4307 Jefferson, Kansas City, Missouri, Apartment 30.

Post Cards.

Blue Bird Correspondence Club. "To promote happiness." Club magazine dime. Swap Bulletin, New York—Detroit.

Exchange.

Swap new wavemeter for No. 2 omnigraph, or will buy. Marvin Swanson, Lancaster, New York.

Bargains—3,500 meter tuner, \$6; 2-43 plate variables, \$5; Crystal detector, \$2.50; triple honeycomb coil unit panel mounting, \$3; Murdock phones, \$3; also fixed condenser, buzzer, formica panel 9 x 12, rheostat, small variable, nickel plated switches, binding posts, contact points. All nearly new. R. Lehmann, 408 Hastings St., Grand Rapids, Mich.

For Sale—One Clapp Eastham semi-quenched rotary spark gap, No. 741; costs \$50, slightly used, yours at \$37.00. Also a Crocker Wheeler 375 volt 50 watt D.C. generator for radiophone work not used over three hours, \$35.00. Both machines in A1 condition. R. S. Drummond, 5421 Crystal St., Chicago, Ill.

Bargain—White Cross electric vibrator, four applicators. Almost new; will take \$8.00. L. Cramer, Fort Ann, New York.

Omnigraph No. 2, Continental dials. Used only few days. Will exchange for receiving apparatus or sell for \$22. S. M. Tucker, 820 N. Jefferson St., Jackson, Miss.

For Sale—Wireless receiving set, \$75; small portable set, \$3; 1/2 K.W. Open core transformer, \$6; detector, \$1.50; kick-back preventer, \$4; telegraph key, \$1.75; moving picture machine, \$3. A Greenberg, R. 2, Hackensack, N. J.

Exchange—Microscope fitted with Bausch & Lomb high power lenses. Bargain at \$40. Carrying case, etc., included. A \$100 course in medicine and small chemical cabinet, \$10 extra. A. R. Dunham, 312 North Center, Marshalltown, Iowa.

For Sale—Audion panels, \$7.00. 4 x 6 Bakelite panel, rheostat, V.T. socket, binding posts, grid condenser. Money back if dissatisfied. Also meter 1/2 K.W. transformer, new, \$12. Orders shipped within 48 hours, postpaid. Fred Lenfesty, 641 Judson Ave., Evanston, Illinois.

For Sale—Clapp Eastham Co., 1,500 meter receiving transformer, \$10.00; 2-17 plate variable condensers, \$5; 1 rheostat, \$7.5; 1 wall insulator, \$7.5; Audiotron double filament detector used 1 hour, \$5. H. W. Johnson, Hurley, Wis., Box 751.

For Sale—Ducks navy loose-coupler never used, \$22.50; 8-volt storage battery, \$15; Murdock variable condenser, \$4; Western Electric receiving bulb, never used, \$8; 1 K.W. transformer core and primary, \$7.50; \$55 takes all. Want transmitting apparatus. Donough Wilson, 913 A St., Lawton, Okla.

(Continued on page 502)

(Continued from page 501)

Exchange—(Continued.)

For Sale—1 Thor. Flex. 1 K.W. Trans., \$25; 1 Commercial type O.T., \$15; 1 Murdock gap, variable speed 8,000; new studs, \$19; 1 large oil immersed glass plate condenser. Guaranteed to hold any 1 K.W. or money back; with oil \$35. 1 pair Holtzer-Cabots 3,000 Fones, \$9.50. Sent C. O. D. express on receipt of one-third price. Wayne Shaffer, Box 482, Youngstown, Ohio.

DeForest honeycomb coils from L25 to L259 minus L50. All for \$5.50. Never used. G. N. Garrison, East Orange, New Jersey.

Bargain—Must sell wireless station. All inquiries answered. N. Kuhn, 4155 N. St. Louis Ave., Chicago, Ill.

For Sale—Universal tuning cabinet No. RC.2, 6,500 meters. Hardly used, \$20. J. F. Wilhelm, 119 W. 4th St., Williamsport, Pa.

Bargain. DeForest P-500 control panel with new B Batteries, \$15. R. Woodbury, Manchester Road, Winchester, Mass.

Undamped Wave Receiving cabinet, including Moorhead tube, \$35. Investigate quick. John Smith, 3650 Marvine, Philadelphia.

For Sale—Complete audion receiving set \$50. Sending set, 34 K.W. Send for list. Rollin H. Stewart, 3023 Blvd. Pl., Indianapolis, Indiana.

Sale—Audiotron panel cabinet, \$7; crystal detector, \$75; hardly used 8x4 1/2 auto inner tube, and 35 x 4 1/2. Make offer. Raymond Schlegel, 1118 N. Negley Ave., Pittsburgh, Pa.

Rare Opportunity—Edison storage battery cells, 150 ampere hour capacity, \$6.50 each. Excellent condition. Discount on quantities. A. R. Spartana, 615 N. Washington St., Baltimore, Md.

For Sale—1-30 H. P. General Electric motor, 110 volts, 60 cycles, \$12. Earle Chapman, Cheboygan, Mich.

For Sale—New \$15, 1 variable inductance, 3,500 meters, 1 phone 1,500 ohm; 1 universal detector; 1 condenser; 2 ball insulators; 1 lightning ground switch; 600 volt-100 amp. 150 ft. aerial wire; parts for a portable radio set. L. Smith, 1200 Greene Ave., Brooklyn, N. Y.

Bargain—Panel complete with bulb and batteries, \$12.50; 3 inch spark coil gives 4, \$10; 1 1/2 inch spark coil, \$5.50; Navy coupler, \$11; Brandes phones, \$5; honeycomb coil mounted, No. 300, \$1.25; key, 50c; buzzer, 35c; Arlington type coupler \$1.50; Navy coupler, \$3.50; Ducks Arlington coupler, \$5.50; Crystal, \$2; Century buzzer, \$1.35; switches, etc. Postage extra. Alon Shewman, 662 Highland Ave., Meadville, Pa.

For Sale Cheap—1 sending transformer 1/2 K.W. Built from Edge-Comply parts in oak case 1 1/16 H.P.; 60 cycle 110 V. motor; 1 12 stud rotor; 2 standards; 1-0-5 hot wire ammeter; 1 Boston type key No. 6 contacts; 30 feet brass ribbon; 1 large change over switch, Murdock type; 1 100 amp. ground switch; 1 condenser rack holds 10 glass plates 10 x 12 inches. Every part in good condition; used only short time; a rare bargain at \$40. Only certified checks accepted. G. F. Shuck, Bedford, Pa.

New Storage Batteries, 6V 50A, \$15; 6V 60A, \$20; 6V 120A, \$35; 12V 50A, \$30; DeForest two-step amplifier, \$40; Baldwin phones, \$10; 1/4 K.W. rotary converter, \$30. F. J. Suchanek, 1400 Ave. A. New York City.

Sale or Trade—Mignon undamped wave unit UW1, \$25, and Mignon detector unit BR1, \$12; both \$35. Consider Grebe two-stage amplifier. Also Amrad quenched gap AG3, \$8. Hintze, 131 Eighth Ave., New York City.

Let's Swap! Buy! Sell! What'ye got? What'ye want? Dime quarterly. Swap Bulletin, New York—Detroit.

For Sale—V. T. cabinet. 2 lightning switches (parts), transformer Acme phones, 400 feet wire. Send for prices. E. E. Rainear, 173 Fayette St., Bridgeton, N. J.

Here's Your Chance—Complete sending and receiving set, \$15, or exchange for omnigraph. Write quick for description. Paul Park, 40 Afterglow Way, Montclair, N. J.

Connecticut Variable Condenser. Perfect condition. Sold for first \$4. G. Garrison, East Orange, New Jersey.

Bargains in radio apparatus. Most all unused. Antenna and inductance wire of twenty three and eight, thirty six and eight gauges; variables, V tubes, receivers, keys, switches, transformer coils, switch points and other articles too numerous to mention. One set of Hawkins electrical guides, and a beautiful gold R. L. A. button. All must be sold. Write for further information. B. Peters, 500 Center St., Chicago, Ill.

For Sale—Receiving set including 3,500 meter navy type loose coupler, detector, condensers, phones, etc., \$35. Particulars free. R. R. Parkhill, 29 E. Gilmore St., Jacksonville, Fla.

Radio Phone Outfit. Will transmit over 5 miles. Price, complete, \$20. Earl Patterson, Box 1055, Roseburg, Oregon.

Exchange—(Continued.)

For Sale—2,500 meter navy type coupler (cabinet style), \$11; Murdock, 2,000 ohm phones, \$3.50; Murdock telephone connection block, 30c; panel type rheostat, \$1; 1-inch Lemke spark coil, \$6.50; pancake helix, \$2.75; all goods absolutely brand new. James Parker, 33 Holland Ave., Ardmore, Pennsylvania.

One Short Wave regenerative receiving set, \$13; transformer core iron, 15c per lb.; two-stage amplifier without tube, \$20; one loud speaking horn, good as new, \$12. A. C. Penfield, Conneautville, Pennsylvania.

For Sale—N. A. A. loose coupler, 3,500 meters, \$6.50. Clarence Ott, 2121 Sheffield Ave., Chicago, Ill.

For Sale—All kinds of wireless and electrical apparatus. List free. D. Nelson, 403 Beacon St., Lowell, Mass.

For Sale—Two cylinder excelsior motorcycle engine, good condition, \$15. Two kilowatt Westinghouse generator, unwound, good condition, \$15. J. Nauta, 141 Butler St., Paterson, N. J.

20,000 Meter undamp navy type coupler, \$18; tickler coil in mahogany cabinet, \$10; Ralph Miller, 136 Hudson St., Reading, Pa.

For Sale—No. 2 junior omnigraph, new, sent collect for \$10. Address Box 3051 You St. P. O., Washington, D. C.

For Sale—Three "Tresco" variable condensers, 2 43-plate and 1 21-plate. \$10 takes 'em all; \$3.84 each. Also Crystalai detector, \$2.50; Malcolm Koch, Station "B," Evansville, Ind.

Attention! 2,500 meter, loose coupler, \$4.50; 1,000 ohm Murdock phone with headband, \$2; crystal detector, 75c; 2 5-inch insulators, new, 50c each. Tubulator fixed condenser, 50c. Laurel Kettler, Piqua, Ohio.

Bargains—Complete chemical laboratory, including balances, text books, apparatus, etc., etc. Description sent for stamp. One 1/2 K.W. transformer coil in good condition. Chas. Knapp, 511 Duff Ave., Ames, Iowa.

For Sale—2 inch coil with interrupter, \$9; 2,500 meter receiving transformer, \$10; detector, \$1; oscillation transformer, \$5. John Knudsen, 2324 Glenside Ave., Norwood, Ohio.

Bargain—\$17.50 navy type receiving transformer. Sell for \$12; perfect condition; little used. George B. James, 1414 S. Vermont St., Sedalia, Mo.

Selling Out—Good as new, 15 disc omnigraph, \$15; loose coupler, 1,000 meters, \$10; Murdock .001 M.F. variable, \$2; Murdock loading inductance, new, \$2.50; 3 multi capacity switches, each \$1.50; new 1/2 K.W. gap and key, each, \$2.50. S. Jones, 5349 Burns St., Detroit, Mich.

For Sale—Radio craft detector cabinet, new, \$10; three Murdock 43 plate variable condensers, new, \$3.50 each; Class 1 vacuum tube used 60 hours, \$4; Class 2 vacuum tube used 1 hour, \$5; DeForest LC-101 honeycomb coil mounting, new, \$8; 14 honeycomb coils, cost \$33, for \$20; eight-stage amplifier panel, bakelite, 14 x 20 inches, has eight each of Marconi sockets, rheostats, telephone jacks and filament switches completely mounted and wired, for \$35, worth \$75; short wave regenerative receiver; good condition, \$15; one inch spark coil, transmitting condenser, splendid spark gap and key, \$6; sending apparatus guaranteed. J. Nauta, 141 Butler St., Paterson, N. J.

Trade—Set Marconi Victor records, code practice, for charging rectifier; 1/2 K.W. Packard transformer. Want Western Electric V.T.'s L. W. Hatry, 2048 5th St., Port Arthur, Texas.

Acc Regenerative Receiver—150 to 3,000 meters complete with V.T. 1; brand new, must sacrifice, cost \$97; sell \$65. Ralph Haile, 811 Lexington Ave., Cincinnati, Ohio.

Sacrifice Twin Cylinder Indian motorcycle for radio apparatus; will take omnigraph as part. Earl Hottel, Middletown, Virginia.

Stromberg-Carlson improved phones in perfect condition. Sacrificed at \$8.50. G. N. Garrison, East Orange, New Jersey.

For Sale—Regenerative Set, pair 3,000 ohms receivers, loose coupler, tuning coil audion detector and bulb. No junk. Write immediately to Edward Gross, 39 Alpine St., Irvington, N. J.

For Sale—Large cabinet set 100-3000 meter range. J. Glauber, 151 North 12th St., Newark, New Jersey.

Exchange—Complete wireless receiving station for motorcycle. A. Greenberg, R. 2, Hackensack, New Jersey.

Swap—Twin "Yale" motorcycle, just overhauled, good condition. Want DeForest 15 unit panel set, with bulbs and coils. Write. John Fisher, Blandinsville, Ill.

For Sale—Qualitative chemical analysis outfit; chemical books; motor, 75c; Erector electrical outfit, \$3.50; 3 variable condensers, \$3.25 each. F. Fletcher, Warner St., Hudson, Mass.

Sell or Trade—Umakem lathe castings and blueprints, \$16; want honeycombs, audions. Harry Ferris, Haskell, Okla.

Real Bargain—Brand new quarer K.W., finely finished, first ten-eighty takes it. J. Fetzer, Thompson Street, Lafayette, Indiana.

Exchange—(Continued.)

500 Volt Motor Generator, International 110 volt A.C. motor, new, cost \$100; sell \$80. A bargain. Ralph Haile, 811 Lexington Ave., Cincinnati, Ohio.

Sacrifice—My complete long-distance station. All apparatus in good condition and of standard make, including audion and one-step and Thordarson 1 K.W. Also complete stock of raw materials for constructing. I will make it worth your while but don't write unless you mean business. G. F. Dunfee, Shenandoah, Iowa.

For Sale—Mignon RW-3 as good as new, \$45. F. J. Demarest, 811 Walnut St., Williamsport, Pa.

Bargains—Jove detector, with galena, \$1; new Century buzzer, \$1.50; Marconi two megohm grid leak, 75c; audiotron adapter, \$1; French army phones, 3,000 ohms, \$5. Edw. F. Durbeck, Snyder, Oklahoma.

Swap or Sell—Experimental lathe, \$50, F.O.B. Andalusia, or swap for Grebe apparatus. What have you? Thos. Conner, Andalusia, Ala.

For Sale—receiving set, with loose coupler, Murdock phone, aerial wire, new, in perfect condition. Price \$16.50. L. C. Bottom, Ong, Nebr.

For Sale—One General Radio Co. one-step amplifier and one two-step amplifier of the same make, both in A1 condition, \$15 and \$35 respectively, without tubes or batteries. Write E. H. Arnold, 19 Westland Rd., Watertown, Mass.

Sale—New 6-100 storage battery. 6-80 battery. Fones. Slide tuner. Marconi jar. DC motor. Potentiometer. 2 new audiotrons. Oscillation transformer. Dial. 8BQ, 234 Vine St., Milton, Pennsylvania.

For Sale—Audion for experimenters, 12 x 14, bakelite panel without tube, \$15; one-step amplifier (Fed. transf.), with tube, \$18. Complete receiving set with Blitzen tuner, \$14. Audion detector and one step amplifier, cabinet, 8 x 10 bakelite panel, 3 variables, VT or audiotron, 2 switches and rheostats, plugs and binding posts for phones. Write for particulars. \$40. Other things—Radio. 240 West 114th St., New York.

For Sale—Wireless set in oak cabinet, bicycle, motorcycle, and wheels, springs and axle for cyclecar. For other particulars write, 541 Vermont Place, Columbus, Ohio.

Sell—3/4 K.W. Thordarson, \$12. Clapp Eastham wavemeter, \$8; two Murdock 43 plate variables, \$3 each; Bunnell double speed key, \$3; lightning switch, \$1.50; two Remler panel rheostats, 90c each; VT socket, 90c. H. Midgley, 39 Pearl St., Tompkinsville, N. Y.

Sending and Receiving Set—Consists of audiotron cabinet, navy coupler, variables, 1 coil, etc. Hardly used; bargain. Write. Charles Ettl, Leonia, N. J.

For Sale—Navy type coupler with detector and condenser. \$15; Murdock phones, \$2.50; Murdock condenser, .001, \$2.50; audiotron cabinet with bulb, \$10; 2 inch spark coil, \$7.50; Helix, key and gap for same, \$3; DeForest two coil mounting and D1000 and L750, \$3. Stuart John, Ardmore, Pa.

Cabinet, 2 variables, fixed grid condensers, various honeycombs, triple holder, rheostat, switches, \$21. Roland Place, Sprague, Fall River, Mass.

Wanted. Rifles, revolvers, pistol shotguns. Any condition. Natalish, Stockbridge, Mass.

Will Sacrifice a complete 1 KW sending set, range 1,000 miles. Also a complete receiving set and a triple coil mounting with honeycombs. Write for particulars. H. Isaacson, 900 Riverside Drive, New York.

Paragon Regenerative short wave receiver, \$15. Felix Fruch, Anaheim, Cal.

Receiving Set—2,500 meter loose coupler, variable condenser, crystal detector, mounted bakelite panel, \$15. David Talianoff, 817 E. 16th St., Brooklyn, N. Y.

BOUND VOLUME No. 1

Radio Amateur News

12 Issues

July, 1919 - June 1920

Attractively Bound

Only \$2.00

(Plus Postage)

A Most Valuable Asset to Your Library

Order Today

Experimenter Pub. Co.

236a Fulton Street New York City

MAGAZINE Prices Slashed

Millions

of magazine subscriptions expire this month! With tremendous advance of paper prices and labor it is certain that nearly all magazines will advance their subscription prices at least from 25% to 50%.

BY ORDERING NOW YOU WILL SAVE BIG MONEY.

In announcing these wonderful prices it is with the absolute knowledge that our readers are offered the lowest prices for standard Magazines that it is possible to obtain anywhere. Only by special arrangement with the publishers are these prices possible, but to take advantage of them, you must act quickly. Don't delay, do it now. This offer is so good that of necessity it must be limited in time. Just think of buying standard Magazines at reduced prices in time for Xmas Presents, and they certainly make ideal gifts being a constant reminder for a whole year of a considerate friend. Just glance over our wonderful prices, and see how we enable one dollar to bring you two dollars' worth, and then make up your list. When sending your order, don't forget to state where magazines are to be sent. But be sure you do it now. To-morrow means you may forget and lose this wonderful opportunity. All prices quoted are for subscribers in U. S. A. only, Canadian and Foreign subscriptions require additional postage.



The
Publishers
Will Mail the
Magazine
Direct From
Their Own
Office to You.

BIG SPECIAL TO "WIRELESS BUGS"

Radio News	Reg. Price \$2.00	Our Price \$13.50
Science & Invention	3.00	
Wireless Age	2.50	
Q. S. T.	2.00	
Everyday Engineering	2.00	
Wireless World (London)	2.75	
Regular Price	\$14.25	
Radio News	Reg. Price \$2.00	Our Price 4.50
Science & Invention	3.00	
Regular Price	\$5.00	
Radio News	Reg. Price \$2.00	Our Price 6.95
Wireless Age	2.50	
Science & Invention	3.00	
Regular Price	\$7.50	
Radio News	Reg. Price \$2.00	Our Price 4.50
Wireless World (London)	2.75	
Regular Price	\$4.75	

Radio News	\$2.00	Our Price 8.50
Scientific American	6.00	
Everyday Engineering	2.00	
Regular Price	\$10.00	
Radio News	\$2.00	Our Price 3.40
Boy's Life	2.00	
Regular Price	\$4.00	
Radio News	\$2.00	Our Price 4.75
Popular Science	3.00	
Regular Price	\$5.00	

Radio News	\$2.00	Our Price 3.40
Boy's Magazine	2.00	
Regular Price	\$4.00	
Radio News	\$2.00	Our Price 6.50
Everybody's	2.75	
Delineator	2.50	
Regular Price	\$7.25	
Radio News	\$2.00	Our Price 5.75
American Magazine	2.50	
Women's Home Companion	2.00	
Regular Price	\$6.50	

Radio News	\$2.00	Our Price 6.75
Wireless Age	2.50	
Illustrated World	3.00	
Regular Price	\$7.50	
Radio News	\$2.00	Our Price 5.75
St. Nicholas	4.00	
Regular Price	\$6.00	
Radio News	\$2.00	Our Price 2.50
Today's Housewife	1.00	
Regular Price	\$3.00	
Radio News	\$2.00	Our Price 7.50
Popular Science	3.00	
Science & Invention	3.00	
Regular Price	\$8.00	



Club No.	Magazine	Reg. Price	Special price With (Radio News)	Club No.	Magazine	Reg. Price	Special price With (Radio News)
80	Adventure	\$4.00	\$5.75	40	Motor Boating	2.00	3.75
50	American	2.50	4.25	60	Munsey's Magazine	3.00	4.75
35	Boy's Life	2.00	3.50	30	McCall's Magazine	1.50	3.25
35	Boy's Magazine	2.00	3.50	30	McClure's Magazine	1.65	3.25
70	Century	4.00	5.25	70	Outing	4.00	5.25
35	Christian Herald	2.00	3.50	20	Pathfinder	1.00	2.75
80	Cosmopolitan	4.00	5.75	50	Pictorial Review	3.00	4.25
100	Country Life	5.00	6.75	60	Popular Science	3.00	4.75
70	Current Opinion	4.00	5.25	70	St. Nicholas	4.00	5.25
50	Delineator	2.50	4.25	95	Scientific American	6.00	6.50
40	Designer	2.00	3.75	80	Scribner's	4.00	5.75
55	Everybody's	2.75	4.50	60	System	3.00	4.75
35	Etude (for Music Lovers)	2.00	3.50	15	Today's Housewife	1.00	2.50
50	Field and Stream	2.50	4.25	45	Wireless Age	2.50	4.00
55	Illustrated World	3.00	4.50	40	Woman's Home Companion	2.00	3.75
80	Literary Digest	4.00	5.75	80	World's Work	4.00	5.75
60	Metropolitan	3.00	4.75	50	Youth's Companion	2.50	4.25
37	Modern Priscilla	2.00	3.60				
60	Motor	3.00	4.75				

For computing together Magazines listed separately, add Class Numbers before title and multiply by 5, giving our price to you in dollars and cents.

Write for Special Prices on ANY Publication not listed here
We will save you money

SEND ALL ORDERS TO "CIRCULATION DEPARTMENT"
EXPERIMENTER PUBLISHING CO., Inc.
236^a Fulton Street, New York City, N. Y.

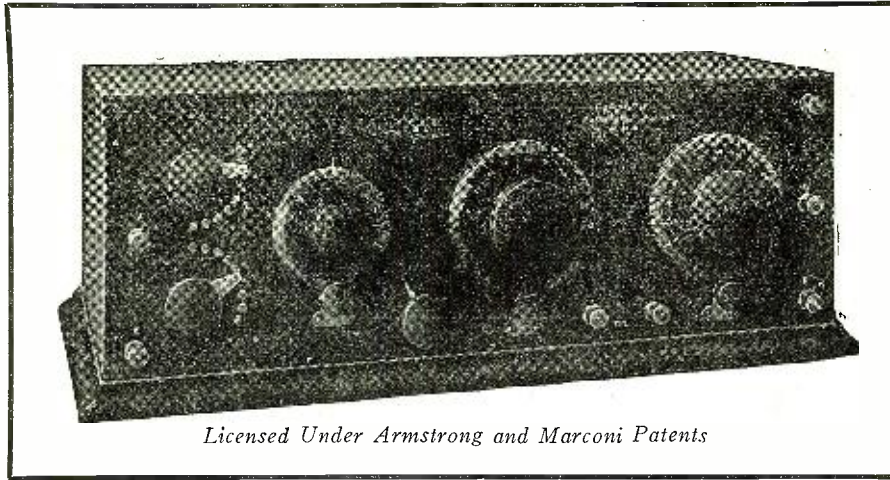

Licensed Under Armstrong and Marconi Patents

Wave Length Range up to 1000 Meters with no decrease in amplification—

AMATEUR, Commercial and Navy wave-lengths,—all are included in the range of the Paragon R.A. Ten! *And all without impairing the amplification one particle.*

Adams-Morgan Company's unapproachable engineers spent two years and thousands of dollars to develop the

PARAGON R.A. TEN

Reg. U. S. Patent Office.

Amplifying Short Wave Receiver

TESTS show that it is 24% more sensitive and selective than even the Paragon R. A. 6. It embodies the most advanced standards of Radio engineering in every detail, but a few of the outstanding features are:

- Wave length, 160 to 1000 meters.
- Amplification, 100 times.
- No dead end losses whatever.
- Vernier attachments on all controls.
- Change of spark tone eliminated.
- Coupling has scale of 180°.
- Guaranteed for *two* years.

PRICE, EIGHTY-FIVE DOLLARS

THOSE who demand the utmost effectiveness in their radio equipment, will not be satisfied with less than the Paragon R. A. Ten. It is as far ahead of the R. A. 6 as that was ahead of all the others.

Send to-day for our interesting and complete bulletin explaining every phase of the Paragon R. A. Ten's superiority. It's free. *A post card brings it!*

*You don't have to live nearby—
to share in Continental Service*

The same courtesy, the same prompt attention to your orders, extends to our mail order department. A few items of our mail order stock are listed below.

OMNIGRAPHS

- No. 313 Omnigraph Complete\$20.00
- No. 2 Jr. Complete..... 28.00
- Extra Dials, each..... .20
- No. 342 Practice Set with battery 4.00

BUZZERS

- No. 55 Mesco 2.25
- No. 251 Mesco80
- No. 168 Century 2.50

AMRAD GAPS

- No. G-1 1 K.W. Gap.. 41.50
- No. G-2 1½ K.W. Gap.. 24.50
- No. G-3 ¼ K.W. Gap.. 16.00

BENWOOD GAPS

- No. 1 Benwood Gap complete 30.00
- No. 8 8 Stud Rotor..... 8.00
- No. 10 10 Stud Rotor .. 8.00
- No. 14 14 Stud Rotor .. 8.00

LINE PROTECTORS

- No. 379 Murdock Line Protector\$9.00
- No. AM888 Dubilier Line Protector 4.00
- No. CD888 Dubilier Line Protector 6.00

TUNGAR RECTIFIERS

- Two Ampere Tungar complete 18.00
- Five Ampere Tungar complete 28.00
- Two Ampere Extra Lamp 4.00
- Five Ampere Extra Lamp 8.00

BURGESS "B" BATTERIES

- 22½ Volts Large "B" Battery 3.50
- 22½ Volts Small "B" Battery 2.50

PARAGON CONTROL PANEL

- No. 5 Paragon Control panel 6.00

Send 25c for our new 112-page catalogue. It is distinguished by the presence of every worth-while make of radio goods and the absence of every line which we cannot honestly recommend.

Our word of honor to you is our guarantee—*Let us prove it.*

CONTINENTAL RADIO AND ELECTRIC CORPORATION

J. DI BLASI, Secretary
DEPT. C-30

Sole Distributors of the Paragon RA-Ten
6 WARREN STREET

J. STANTLEY, Treasurer
NEW YORK

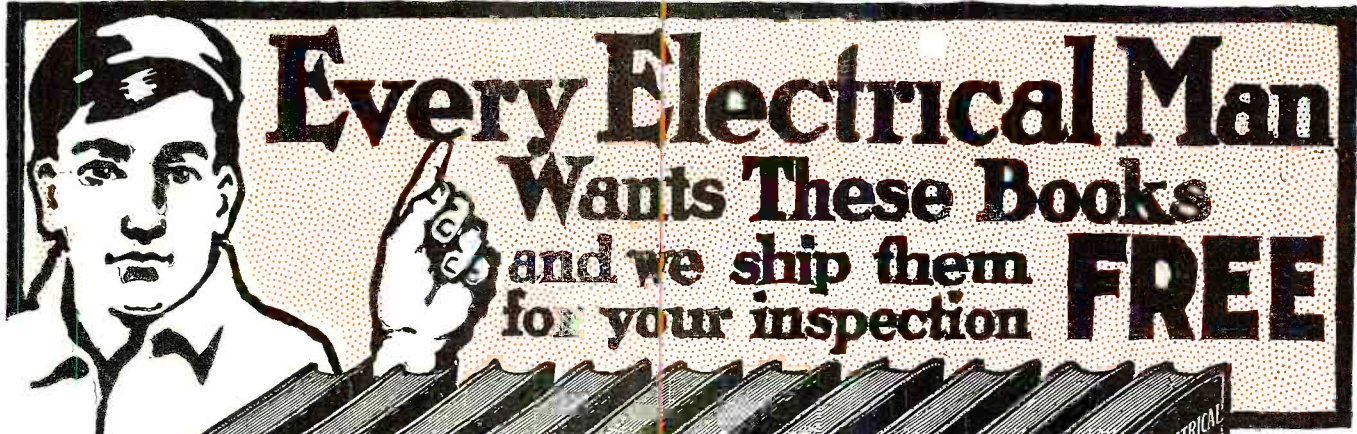

Every Electrical Man Wants These Books and we ship them **FREE** for your inspection

Flexible
Covers
—
Handy
Pocket-
Size
Volumes

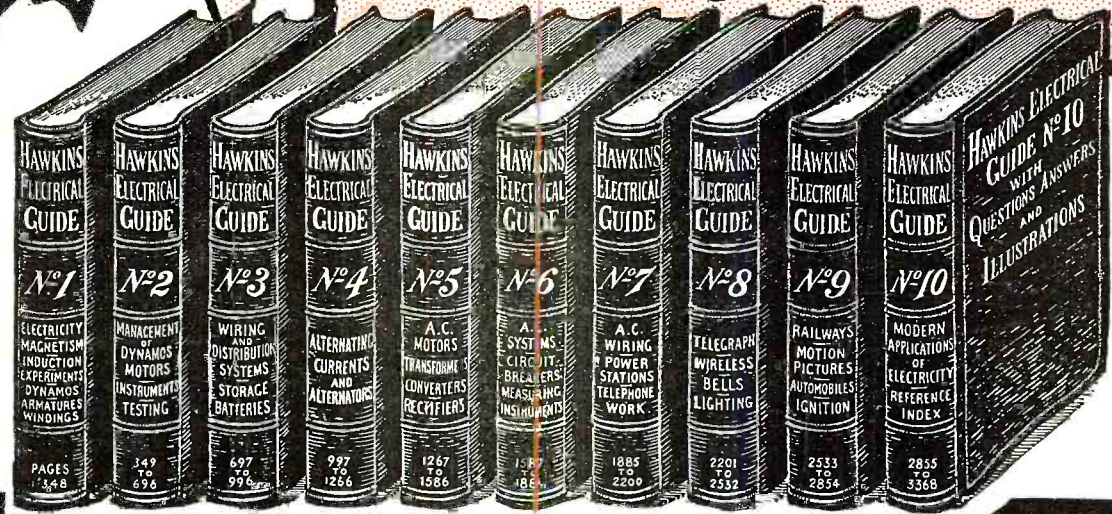

10
Volumes
3500
Pages
4700
Pictures
\$1 Per
Volume
\$1 Per
Month

Just what you need to know to succeed in **ELECTRICITY**

EVERY electrician, every engineer, every mechanic should know about these wonderfully helpful instructive books, which give in plain words a complete working knowledge of electrical engineering in all its phases.

You run into some new electrical problem almost every day. The information you need to help you in your every day work is in

HAWKINS ELECTRICAL GUIDES

These books place electricity at your finger ends. They cover every imaginable subject, principle, theory, problem, trouble, and way of doing things electrically. Every subject is indexed so that you can turn right to it. They are a study course and a reference guide in one, written in plain every day language—no wasted words—only what you need to know—chock full of up-to-the-minute electrical knowledge. The guides are a complete course in electrical engineering. They will help you in every detail of the day's electrical work. You can't ask an electrical question that Hawkins Guides can't answer.

Pocket-Size Flexible Covers

The books are small enough to slip into your coat pocket—handsomely bound in flexible black covers. You can carry each volume with you until you have mastered its contents. 3,500 pages of actual information and 4,700 illustrations. Once you see these books and put them into actual use you will never again want to be without them. Try it at our expense.

SEND NO MONEY

It will cost you nothing to receive these books—to look them over—ask them all the questions you can think of—use them in your work—study them—pick up some information that will increase your earning ability. We will ship you the entire set of 10 volumes entirely FREE.

This is a sign of our confidence in the guides. Pure gold does not object to being tested. Keep them for seven days and if you do not decide that you can't get along without them, return them to us and owe us nothing.

When you decide to keep them you only have to pay \$1.00 down and remit the balance of \$9.00 on the easy payment of \$1.00 a month till paid for.

Use this coupon to get the books. It will pay you many times over

THEO. AUDEL & CO.
72 Fifth Ave. New York, N. Y.

SEND NO MONEY - USE THE COUPON

READ THIS PARTIAL LIST OF CONTENTS

- No. 1** Contains 348 pages, 388 illustrations. Electrical signs and symbols—static and current electricity—primary cells—conductors and insulators—resistance and conductivity—magnetism—induction coils—dynamo principles—classes of dynamos—armatures—windings—commutation—brushes, etc.
- No. 2** Contains 348 pages, 394 illustrations. Motor principles—armature reaction—motor starting—calculations—brake horsepower—selection and installation of dynamo and motors—galvanometers—standard calls—current measurement—resistance measurement—voltmeters—wattmeters—hour meters—operation of dynamos—operation of motors, etc.
- No. 3** Contains 300 pages, 423 illustrations. Distribution systems—wires and wire calculations—inside, outside and underground wiring—sign flashers—lighting protection—rectifiers—storage battery systems, etc.
- No. 4** Contains 270 pages, 379 illustrations. Alternating current principles—alternating current diagrams—the power factor—alternator principles—alternator construction—windings, etc.
- No. 5** Contains 320 pages, 614 illustrations. A. C. Motors—synchronous and induction motor principles—A. C. commutator motors—induction motors, transformers; losses, construction—connections, tests—converters—rectifiers, etc.
- No. 6** Contains 298 pages, 472 illustrations. Alternating current systems—switching devices—circuit breakers—relays—lightning protector apparatus—regulating devices—synchronous condensers—indicating devices—meters—power factor indicators—wave form measurement—switch boards, etc.
- No. 7** Contains 316 pages, 379 illustrations. Alternating current, wiring power stations—turbines; management, selection, location, erection, testing, running, care and repair—telephones, etc.
- No. 8** Contains 332 pages, 436 illustrations. Telegraph—simultaneous telegraphy and telephony—wireless—electric bells—electric lighting—photometry, etc.
- No. 9** Contains 322 pages, 627 illustrations. Electric railways—electric locomotives—car lighting—trolley car operation—miscellaneous applications—motion pictures—gas engine ignition—automobile self-starters and lighting systems, electric vehicles, etc.
- No. 10** Contains 613 pages, 599 illustrations. Elevators—cranes—pumps—air compressors—electric heating—electric welding—soldering and brazing—industrial electro-lysis—electro plating—electro-therapeutic—X-rays, etc.

Also a complete 126-page ready reference index of the complete library. This index has been planned to render easily accessible all the vast information contained in the 10 electrical guides. There are over 13,500 cross references. You find what you want to know instantly.

THEO. AUDEL & CO.
72 Fifth Ave.
New York, N. Y.

Please submit me for examination Hawkins Electrical Guides (price \$1 each). Ship at once, prepaid, the 10 numbers. If satisfied I agree to send you \$1 within seven days and to further mail you \$1 each month until paid.

Signature.....
Occupation.....
Employed by.....
Residence.....
Reference.....

What Electrical Men Say
Helped Him Make Good
"It is only right for me to recommend highly the Hawkins Guides, for they have been of the greatest assistance to me in placing me in my present position as Superintendent of Construction Department of one of Ohio's largest Electrical Companies. I would like to see every man have a set of Hawkins Guides."
Geo. Knecht, Columbus, Ohio.

In the Naval Electrical Dept.
"The Hawkins Guides are great help to me in the Naval Electrical Department, which they cover very thoroughly."
C. J. Cornell, U. S. Receiving Ship, Brooklyn, N. Y.

Superintendent
"I am now superintendent of the Dunnville Hydro-Electric Systems, and Hawkins Guides were a great help to me in holding down a responsible position."
W. E. Swartz, Dunnville, Ontario.

Wireless Operators
"I have worked wireless for ten years—but I wish I had these books years ago, as they have saved me a great deal of trouble."
H. Marshall, Steamer M & B No. 2, Walkerville, Ont.

LEARN WIRELESS At Home By Mail

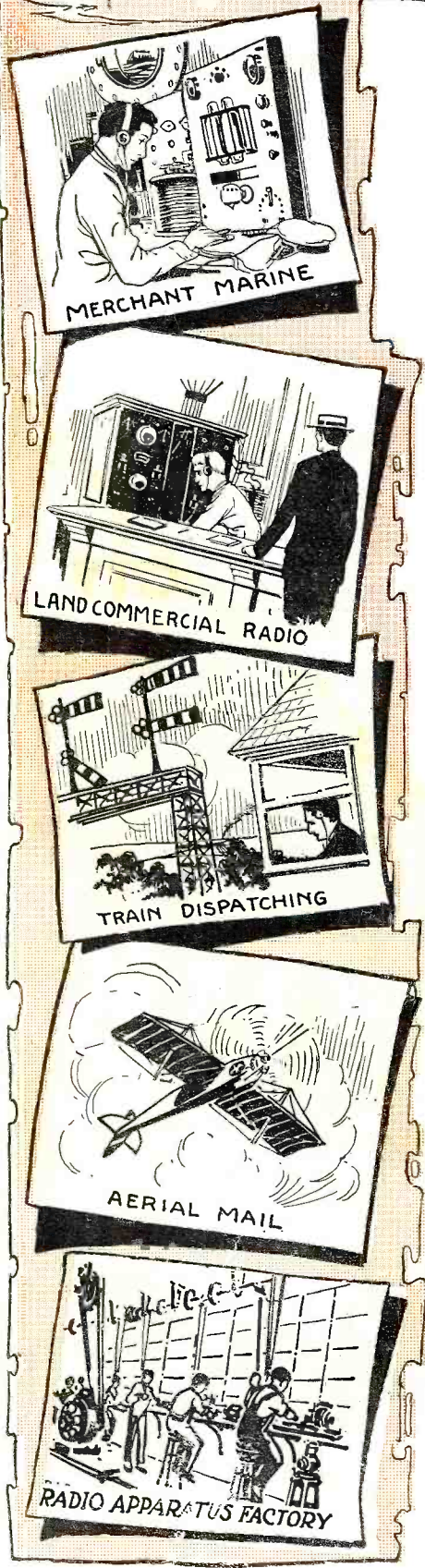

Calls coming in steadily for National Radio Institute Graduates. Big Concerns in Need of Operators.

Many attractive positions are now open in Merchant Marine, Commercial Land Radio Service, Radio Supply Factories, U. S. Navy, Aerial Mail, and large Business Corporations.

Salaries Up to \$3,500.00 a Year

Exceptional opportunity for ambitious men for promotion to the higher branches of Radio. Our graduates are qualified as Senior Operators, and besides Room and Board, receive \$125 a month to start, which altogether means more than \$200. Positions to which they can promote themselves are as follows: Supercargo and Wireless Operator—\$175 a month; Radio Mechanic—\$1,500 to \$2,000 a year; Radio Aid—\$6.00 to \$8.00 per day; Radio Inspector—\$1,500 to \$3,000 a year; Radio Engineer—\$6,000 and more a year; Radio Draftsman—\$7.00 to \$10.00 a day. You can learn wireless the National Radio Institute way, quickly and easily, by mail right in your own home, in your spare time. No previous experience or training is necessary. With our help you can quickly qualify for first grade government license and a fine position.

U. S. Department of Commerce Recognizes N. R. I.

and allows its graduates 5 to 10 points credit when taking the examination for First Grade Government License. This school heads the printed list of reputable Wireless Schools recommended by the U. S. Shipping Board.

Travel Without Expense

If you are eager to travel, anxious to visit foreign countries, and increase your knowledge of world affairs, Wireless offers the

chance of a life time. On shipboard you are rated as an officer. You need not travel unless you wish, but may secure a position at one of the many ever increasing land radio offices.

Pay As You Learn

Our plans of payment place a wireless education within the reach of anyone who desires to learn. A small payment down, and the small payments made during the course make it possible for you to earn the cost of your tuition while actually learning to be a wireless operator.

New Automatic Wireless Instrument Free

In addition to all necessary text books and other equipment with which we supply you, we furnish FREE to every student our marvelous new automatic Natrometer, which transmits Wireless messages in 600 different combinations, and can be regulated to operate at any speed from 1 to 30 words a minute.

It is complete with phones, etc., and is sent you in a neat carrying case. This instrument is operated entirely without the use of aerials and is used exclusively by the National Radio Institute to teach Wireless at home in the scientific way.

You receive the instrument after your enrollment; it becomes your personal property upon completion of our course.

FREE. In addition to our complete course in Radio Telegraphy, every student is given our complete course in modern Radio Telephony. These combined courses enable our students to fill positions requiring a knowledge of both Radio Telegraphy and Telephony.

Send the following coupon today for our FREE BOOK containing all particulars.

NATIONAL RADIO INSTITUTE
Department 422 WASHINGTON, D. C.

MAIL THIS COUPON TODAY

NATIONAL RADIO INSTITUTE,
Dept. 422,
Washington, D. C.

Send me your FREE book "Wireless The Opportunity of Today." Tell me about your Home Study Course in Wireless Telegraphy and Telephony—the free post-graduate course—and your Special Instrument offer.

Name

Address

City..... State.....